

# Operating instructions for the system user

**VIESSMANN**

Control unit for solar thermal systems



## VITOSOLIC 200



## Safety instructions

### For your safety



Please follow these safety instructions closely to prevent accidents and material losses.

#### Safety instructions explained



##### **Danger**

This symbol warns against the risk of injury.



##### **Please note**

This symbol warns against the risk of material losses and environmental pollution.

#### **Note**

Details identified by the word "Note" contain additional information.

#### Target group

These operating instructions are intended for system users.

This appliance can also be operated by children of 8 years and older, as well as by individuals with reduced physical, sensory or mental faculties or those lacking in experience and knowledge, provided such individuals are being supervised or have been instructed in the safe use of this appliance as well as in any risks arising from it.



##### **Please note**

Supervise children in the proximity of the appliance.

- Never permit children to play with the appliance.
- Cleaning and maintenance must not be carried out by unsupervised children.

#### Appliance connection

- The appliance may only be connected and commissioned by authorised contractors.
- Observe the specified electrical connection requirements.
- Modifications to the existing installation may only be carried out by authorised contractors.



##### **Danger**

Incorrectly executed work on the system can lead to life-threatening accidents.  
Work on electrical equipment must only be carried out by a qualified electrician.

#### Work on the appliance

- All settings and work on the appliance must be carried out as specified in these operating instructions. Further work on the appliance may only be carried out by authorised contractors.
- Never open the appliance.
- Never change or remove fitted accessories.

#### In case of fire



##### **Danger**

Fire presents a risk of burns and explosion.

- Switch the system OFF.
- Use a tested fire extinguisher, class ABC.

#### Auxiliary components, spare and wearing parts



##### **Please note**

Components that were not tested with the system may cause system damage, or may affect its functions.  
Have all installation or replacement work carried out by qualified contractors.

## Commissioning

The commissioning and adjusting of the control unit to local conditions and to building characteristics, plus the instruction of the user in operating the system, must be carried out by your heating contractor.

**Operation**

**Controls**

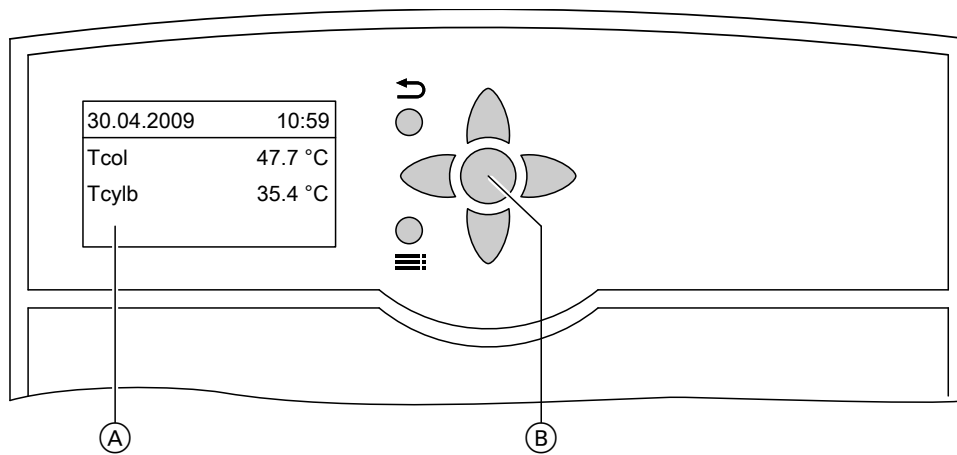

Fig. 1





- Ⓐ Standard display  
The standard display is shown automatically after approx. 4 min.
- Ⓑ OK key; to confirm your selection or save the setting.
- ↶ Takes you to the previous step in the menu or cancels a setting that has been started.
- ▲ / ▼ Cursor keys  
To scroll through the menu.
- ▶ / ◀ Cursor keys  
To adjust values.
- ≡ To change between standard display and main menu.

The display only shows 4 lines of text. The arrow on the left of the display highlights the available menu item.

Use ▲ / ▼ to scroll through the menu.

## Calling up actual values

Press the following keys:

1.  for the "Main menu".
2. **OK** the first 3 actual values will be displayed.
3.  /  for the following actual values, subject to system equipment level.
4.  until the "Main menu" appears.

"Actual values:"	Explanation
"Tcol"	Collector temperature in °C
"Tcol2"	Collector temperature in an additional collector array in °C
"Tcylb"	Actual cylinder temperature in °C
"Tcyl2b" to "Tcyl4b"	Actual cylinder temperature for additional consumers (e.g. 2nd DHW cylinder) in °C
"Tby"	Bypass temperature in °C
"T-HE"	Temperature in an external heat exchanger in °C
"Cyl. add."	Additional function for DHW heating
"Time"	
"Date"	
"Relay"	Condition of relays
"Sensors"	Temperature at the respective sensor in °C  <b>Note</b> <i>If the sensor inputs are not connected, the breaking value (indicating a lead break) is displayed.</i>
"Intens."	Radiation intensity in conjunction with a solar cell  <b>Note</b> <i>If the input is not connected, the breaking value (indicating a lead break) is displayed.</i>

A diagram in the **standard display** enables you to check the collector and actual cylinder temperatures over the course of the day. If your heating contractor has enabled the heat meter, a diagram is also displayed showing the heat amount for the past 7 days.

Repeatedly press , this brings up the following diagrams:

Actual cylinder temperature curve

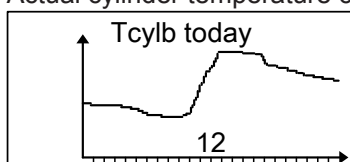

Fig. 2

Collector temperature curve

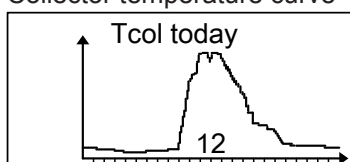

Fig. 3

Heat amount in kWh

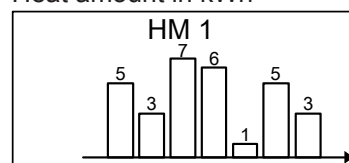

Fig. 4

**Note**

*The bar on the very right indicates the value in kWh for the **current** day.*

## Scanning options

### Calling up messages

Press the following keys:

1.  for the "Main menu".
2.  for "Messages".
3. **OK** to confirm.
4.  to display further messages (see table below).

"Messages:"	Explanation
No fault	There is no fault at the solar control unit.
"Loading cyl" (only with several consumers)	The display shows which consumer is being heated.
"Pause cyl" (only with several consumers)	Only if the "Cyclical heating" function has been enabled by your heating contractor: Pause in the heating of the displayed consumer.
"Cyl. set"	The consumer displayed has reached its set value.
"Fault"	A fault has occurred at the solar control unit (to check the cause, see page 9).
"SW version"	Software version (only for service engineers)
"HW version"	Hardware version (only for service engineers)

### Scanning statement values

Press the following keys:

1.  for the "Main menu".
2.  for "Solar".
3. **OK** to confirm.
4.  for "Statement".
5. **OK** to confirm.
6.  /  for the following statement values, subject to system equipment level.
7.  until the "Main menu" appears.

"Statement"	Explanation
"Colmax"	Maximum collector temperature in °C
"Col2max"	Maximum collector temperature in an additional collector array in °C
"Cylmax"	Maximum cylinder temperature in °C
"Cyl2max" to "Cyl4max"	Maximum cylinder temperature for additional consumers (e.g. 2nd DHW cylinder) in °C
"Relay 1" to "Relay 7"	Hours run of the actuators connected at the relay (e.g. solar circuit pump at R1)
"Days"	Days in operation, solar control unit





To reset the values, except value for days in operation: **2. OK** to confirm

Whilst the value is displayed, press the following keys:

1. **OK** "Delete?" "Yes" is displayed.

## Calling up the heat amount

Press the following keys:

1.  for the "Main menu".
2.  for "HM".
3. **OK** to confirm.
4.  for "HM 1" or "HM 2".
5. **OK** to confirm.
6.  /  for the following values, subject to system equipment level.
7.  until the "Main menu" appears.

"HM ..."	Explanation
"Tflow"	Flow temperature in °C
"Tretn"	Return temperature in °C
"Heat"	Heat amount in Wh
"Heat"	Heat amount in kWh
"Heat"	Heat amount in MWh

### Note

*Add the heat values together.*

*The values are not calibrated.*

*If there is a power failure, the displayed value showing the heat amount may be up to 6 hours old.*

### To reset the heat amount values:

Whilst the value is displayed, press the following keys:

1. **OK** "Delete?" "Yes" is displayed.
2. **OK** to confirm

What to do if...

### The solar thermal system does not start

Cause	Remedy
The ON/OFF switch is switched off.	Switch the ON/OFF switch ON.
The solar control unit MCB has responded (mains voltage is present, display is not illuminated).	Inform your local heating contractor.
Collector limit temperature or set cylinder temperature has been reached.	Wait until the relevant temperature has fallen below its respective limit.
The solar control unit is in <b>"Manual mode"</b> .	Select <b>"Auto"</b> as follows: 1. Press <b>≡</b> : 2. Press <b>▼</b> until <b>"Manual mode"</b> is displayed. 3. Press <b>OK</b> to confirm. 4. Press <b>▼</b> until <b>"Relay 1"</b> etc. is displayed. 5. Press <b>OK</b> to confirm. 6. Press the <b>▲ / ▼</b> keys for <b>"Auto"</b> . 7. Press <b>OK</b> to confirm. 8. Press <b>↶</b> until <b>"Main menu"</b> is displayed.

### There is no DHW available

Cause	Remedy
The solar control unit is faulty.	Inform your local heating contractor.
Collector temperature is too high; safety shutdown by the solar control unit.	Wait until the collector temperature has dropped.
The set cylinder temperature (set DHW temperature) has been set too low.	Inform your local heating contractor.
The solar circuit pump is faulty.	Inform your local heating contractor.
The DHW cylinder is not being reheated: The operating and time program is incorrectly set at the boiler control unit.	Enable DHW heating.   Operating instructions of the boiler control unit

### The display is dark

Cause	Remedy
Power failure	The solar control unit automatically returns to operation once the power supply has been restored.
The power distribution MCB (main domestic MCB) has responded (no mains voltage is present).	Check the MCB and inform your heating contractor if necessary.

### The display illumination flashes

Cause	Remedy
Solar thermal system fault.	Call up the fault (see following chapter) and contact your local heating contractor if necessary.







## Calling up faults

If any faults have occurred in your solar thermal system, the display illumination flashes and **"Fault"** appears on the standard display.

30.04.2009	10:59
Tcol	47.7 °C
Tcylb	35.4 °C
Fault	

Fig. 5

Press the following keys:

1.  for the **"Main menu"**.
2.  for **"Messages"**.
3. **OK** to confirm.
4.  /  for causes of the current fault.
5. Make a note of the cause of the fault.  
This enables the heating contractor to be better prepared for the service call and may save additional travelling costs.
6.  until the **"Main menu"** appears.

### Example of a fault message

Lead break, cylinder temperature sensor

Messages:
Cyl set
! Interruption
>Sensor 2<

Fig. 6

### Inspection and maintenance

#### DHW cylinder (if installed)

Standards DIN 1988-8 and EN 806 specify that maintenance and cleaning should be carried out no later than 2 years after commissioning and as required thereafter.

Only a qualified heating contractor should clean the inside of a DHW cylinder and the DHW connections. If any water treatment equipment (e.g. a sluice or injection system) is installed in the cold water supply of the DHW cylinder, ensure this is refilled in good time. In this connection, observe the manufacturer's instructions.

In addition for Vitocell 100:

We recommend that the correct function of the sacrificial anode is checked annually by your heating contractor.

The function of the sacrificial anode can be checked without interrupting the system operation. The heating contractor will check the earth current with an anode tester.

#### Safety valve (DHW cylinder)

The function of the safety valve must be checked every six months by the user or a contractor through venting (see valve manufacturer's instructions). The valve seat may become contaminated.

Water may drip from the safety valve during a heat-up process. The outlet is open to the atmosphere and must not be closed off.

#### Potable water filter (if installed)

To maintain high hygienic standards, proceed as follows:

- Replace filter element on non-back flushing filters every six months (visual inspection every two months).
- On back flushing filters, back flush every two months.

### Damaged cables / lines

If there is damage to the connecting cables or lines of the appliance or externally installed accessories, these must be replaced with special cables or lines. Only use Viessmann cables / lines as replacement. For this, notify your qualified contractor.

**Menu overview**

Subject to the specific system equipment level and range of functions (set by your heating contractor), the displays may vary from the examples illustrated here.

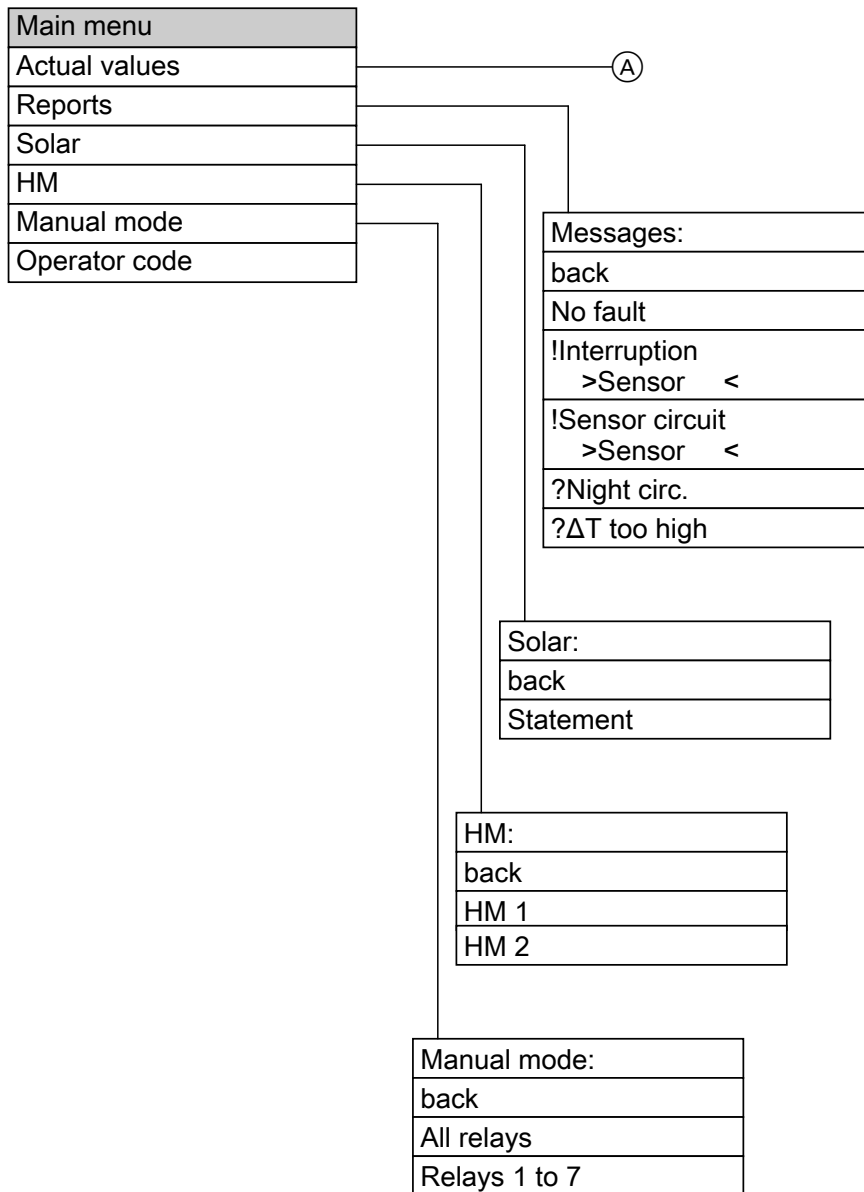

Fig. 7

Ⓐ See page 5.

## Your contact

Contact your local contractor if you have any questions regarding the maintenance and repair of your system. You may, for example, find local contractors on the internet under [www.viessmann.com](http://www.viessmann.com).

Viessmann Werke GmbH & Co. KG  
D-35107 Allendorf  
Telephone: +49 6452 70-0  
Fax: +49 6452 70-2780  
[www.viessmann.com](http://www.viessmann.com)

Viessmann Limited  
Hortonwood 30, Telford  
Shropshire, TF1 7YP, GB  
Telephone: +44 1952 675000  
Fax: +44 1952 675040  
E-mail: [info-uk@viessmann.com](mailto:info-uk@viessmann.com)