

Operating instructions

for the system user

VIESSMANN

OpenTherm room temperature controller with digital time switch
For Vitodens 100-W, 111-W and 050-W

Room temperature controller



Safety instructions

For your safety



Please follow these safety instructions closely to prevent accidents and material losses.

Safety instructions explained



Danger

This symbol warns against the risk of injury.

Note

Details identified by the word "Note" contain additional information.



Please note

This symbol warns against the risk of material losses and environmental pollution.

Target group

These operating instructions are designed for heating system users. This appliance can also be operated by children 8 years and older, as well as by individuals with reduced physical, sensory or mental faculties or those lacking in experience and knowledge, provided such individuals are being supervised or have been instructed in the safe use of this appliance and any risks arising from it.



Please note

Supervise children in the proximity of the appliance.

- Never permit children to play with the appliance.
- Cleaning and maintenance must not be carried out by unsupervised children.

Connecting the appliance

- Connection and commissioning of the appliance may only be carried out by authorised contractors.
- Only operate the appliance with suitable fuels.
- Adhere to the electrical connection requirements.
- Modifications to the existing installation may only be carried out by authorised contractors.



Danger

Incorrectly executed work on the heating system can lead to life threatening accidents.

- Work on gas installations must only be carried out by a registered gas fitter.
- Work on electrical equipment must only be carried out by a qualified electrician.

For your safety (cont.)

Working on the appliance

- When adjusting settings and carrying out work on the appliance always follow the guidelines in these operating instructions.
Additional work on the appliance may only be carried out by authorised contractors.
- Never open the appliance.
- Never remove the cladding.
- Never remove or change additional parts or installed accessories.
- Never open or retighten pipe connections.



Danger

Hot surfaces can cause burns.

- Never open the appliance.
- Never touch the hot surfaces of uninsulated pipes, fittings or flue pipes.

Damage to the appliance



Danger

Damaged equipment poses a safety hazard.

Check the appliance for external damage. Never start up a damaged appliance.

If you smell gas



Danger

Escaping gas can lead to explosions which may result in serious injury.

- Do not smoke. Prevent naked flames and sparks. Do not switch lights or electrical appliances on or off.
- Close the gas shut-off valve.
- Open windows and doors.
- Evacuate any people from the danger zone.
- Notify your gas and power supply utility and your local heating contractor from outside the building.
- Have the power supply to the building shut off from a safe place (outside the building).

Safety instructions

For your safety (cont.)

If you smell flue gas



Danger

Flue gas can lead to life threatening poisoning.

- Shut down the heating system.
- Ventilate the installation site.
- Close all doors in the living space.

Emergency contact

If you smell gas or detect a gas leak call the National Gas Emergency service on 0800 111 999. Notify your gas or electricity supplier and your heating contractor.

- Shut off the electricity supply to the building from a safe place (outside the building).

In case of fire



Danger

Fire presents a risk of burns and explosion.

- Shut down the heating system.
- Close the shut-off valves in the fuel supply lines.
- Use a tested fire extinguisher, class ABC.

What to do if water escapes from the appliance



Danger

If water escapes from the appliance there is a risk of electrocution.

- Switch OFF the heating system at the external isolator (e.g. fuse box, domestic distribution board).
- Notify heating contractor.

What to do if the heating system develops a fault



Danger

Fault messages indicate faults in the heating system. If faults are not rectified, they can have life threatening consequences.

Do not acknowledge fault messages several times in quick succession. Inform your heating contractor so the cause can be analysed and the fault rectified.

For your safety (cont.)

Installation room requirements



Danger

Sealed vents result in a lack of combustion air. This leads to incomplete combustion and the formation of life threatening carbon monoxide.

Never cover or close existing vents.

Do not make any subsequent modifications to the building characteristics that could affect safe operation (e.g. cable/pipe-work routing, cladding or partitions).



Danger

Easily flammable liquids and materials (e.g. petrol, solvents, cleaning agents, paints or paper) can cause deflagration and fire.

Never store or use such materials in the boiler room or in direct proximity to the heating system.



Please note

Incorrect ambient conditions can lead to heating system damage and can put safe operation at risk.

- Ensure ambient temperatures are above 0 °C and below 35 °C.
- Prevent air contamination by halogenated hydrocarbons (e.g. as contained in paints, solvents or cleaning fluids) and excessive dust (e.g. through grinding/polishing work).
- Avoid continuously high humidity levels (e.g. through continuous drying of washing).

Extractors

The operation of appliances that extract air to the outside (cooker hoods, extractors, air conditioning units, etc.) can create negative pressure. If the boiler is operated at the same time, this can lead to reverse flow of the flue gas.



Danger

The simultaneous operation of the boiler and appliances that extract air to the outside can result in life threatening poisoning due to reverse flow of the flue gas.

Take suitable steps to ensure an adequate supply of combustion air. If necessary, contact your contractor.

Safety instructions

For your safety (cont.)

Auxiliary components, spare and wearing parts



Please note

Components not tested with the heating system may damage the system or affect its function.

Only allow qualified contractors to carry out installation or replacement work.

Index

Information

Symbols.....	9
Intended use.....	10

Introductory information

Control unit function modes.....	11
----------------------------------	----

Where to find the controls

Summary of controls and indicators.....	12
■ Controls and display elements.....	12
■ Symbols on the display.....	13

Commissioning

Heating system operating mode.....	15
Time program or operating mode.....	16
■ Selecting the time program or operating mode.....	16
■ Preset time programs.....	16
■ Constant operating modes.....	17
■ Changing the selected time program and set temperatures.....	18

Central heating

Selecting the operating mode.....	20
Temporarily changing the room temperature.....	20
■ Temporarily changing the set room temperature.....	20
■ Comfort mode.....	20
■ Reduced mode.....	21
Permanently changing the room temperature.....	21
■ Changing the heating curve for weather-compensated operation.....	22
Changing the room temperature for a few days (holiday mode).....	24
■ Stopping or interrupting the holiday program.....	25

DHW heating

Setting the time program and DHW temperature.....	26
■ Changing or deleting switching times.....	26
■ Temporarily changing the DHW temperature.....	26

Further adjustments









Time and date.....	27
Summer/wintertime.....	27
Further settings.....	27
Setting the language.....	28
Changing the default display.....	28
Setting the contrast.....	29

Index

Index (cont.)

Locking out controls (key lock).....	29
■ Temporarily interrupting or unlocking key lock.....	29
Changing the display format of fault messages.....	29
Returning all settings to their delivered condition.....	29
Checks	
Checking information.....	30
What to do if...	
Rooms are too cold.....	31
Rooms are too hot.....	31
Carrying out a reset.....	32
Maintenance	
Cleaning.....	33
Appendix	
Menu structure in setting mode (MODE).....	34
Menu structure in settings.....	34
Keyword index	36

Symbols

Symbol	Meaning
	Reference to other document containing further information
	Step in a diagram: The numbers correspond to the order in which the steps are carried out.
	Warning of material losses and environmental pollution
	Live electrical area
	Pay particular attention.
	<ul style="list-style-type: none"> ■ Component must audibly click into place. or ■ Acoustic signal
	<ul style="list-style-type: none"> ■ Fit new component. or ■ In conjunction with a tool: Clean the surface.
	Dispose of component correctly.
	Dispose of component at a suitable collection point. Do not dispose of component in domestic waste.

Information

Intended use

The appliance is intended solely for installation and operation in sealed unvented heating systems that comply with EN 12828, with due attention paid to the associated installation, service and operating instructions. It is only designed for heating up heating water that is of potable water quality.

Intended use presupposes that a fixed installation in conjunction with permissible, system-specific components has been carried out.

Commercial or industrial usage for a purpose other than heating the building or DHW shall be deemed inappropriate.

Any usage beyond this must be approved by the manufacturer in each individual case.

Incorrect usage or operation of the appliance (e.g. the appliance being opened by the system user) is prohibited and will result in an exclusion of liability. Incorrect usage also occurs if the components in the heating system are modified from their intended use (e.g. if the flue gas and ventilation air paths are sealed).

Control unit function modes

Your heating contractor set the function mode during commissioning.

Two function modes are possible:

- Room temperature-dependent operation: If no outside temperature sensor and no heating circuit with mixer is connected, function mode "**ROOM-CONTROL**" must be selected.
- Weather-compensated operation: If an outside temperature sensor and a heating circuit with mixer are connected, function mode "**OT CONTROL**" must be selected.

The settings you can make vary depending on the function mode selected.

Note

DHW heating is active continuously or in accordance with the set switching times, regardless of the function mode set.

Function mode set by the heating contractor

- "**ROOM-CONTROL**" (room temperature-dependent operation)
- "**OT CONTROL**" (weather-compensated operation)

Note

You will have to select the function mode again following a reset.

Where to find the controls

Summary of controls and indicators

Controls and display elements

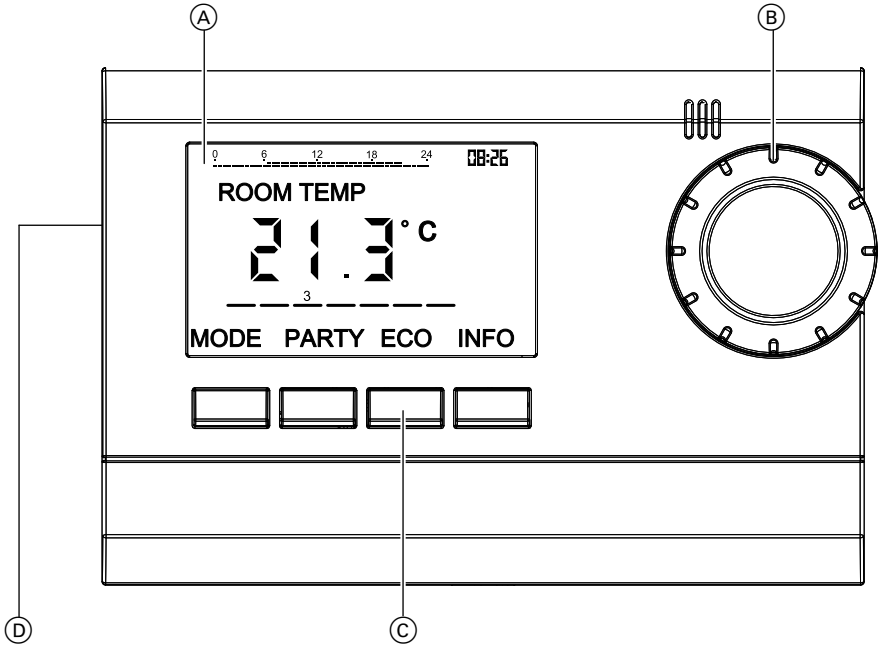

(A) Display

(B) Rotary selector for changing the temperature/value

(C) Keys

(D) Reset (see page 32)

Summary of controls and indicators (cont.)

Symbols on the display

These symbols are not always displayed, but appear subject to operating conditions.

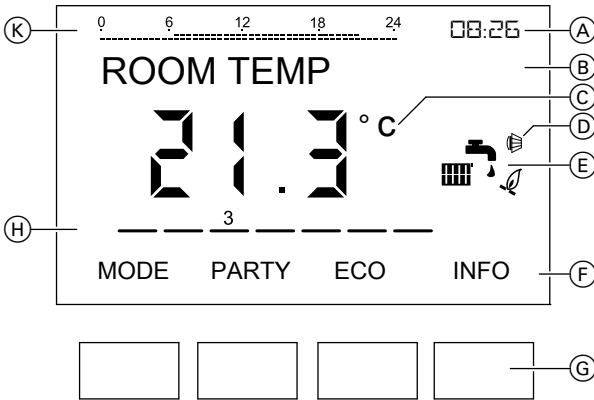

- (A) Time
- (B) Text line
- (C) Temperature display
- (D) Weather-compensated mode
- (E) Operating display
- (F) Function display
- (G) Keys
- (H) Weekday
- (K) Time program (set switching times)

Controls

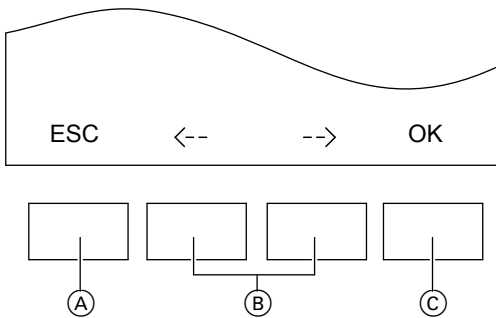

- (A) Step back in the menu/exit menu (Esc)



Where to find the controls

Summary of controls and indicators (cont.)

- Ⓑ +/-: Change value
←-/->: Scroll through menu
- Ⓒ Confirm selection
Save value

Default display

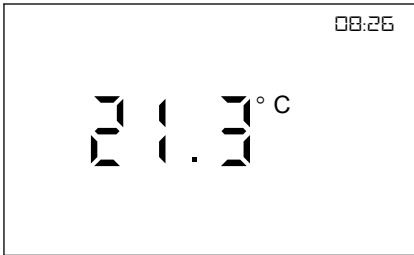

When idle, the screen always shows the room temperature, time and (subject to settings) selected time phases as the default display.

Press **INFO** to access control mode.

Information on operation

You can perform most setting and selection procedures using the +/- keys or the rotary selector.

The following only describes how to control the device using the keys.

Heating system operating mode

Depending on the installation and settings, your heating system is either room temperature-dependent or weather-compensated in conjunction with an outside temperature sensor.

- In **room temperature-dependent mode**, the set room temperature is controlled via the flow temperature.
- In **weather-compensated mode with room influence**, the set room temperature is controlled via the selected heating curve and room influence factor. The room influence factor can be set by your local heating contractor.
- In **weather-compensated mode without room influence**, the room temperature is controlled via thermostatic valves. At the temperature levels Comfort 1 to 3 and Party, the flow temperature is controlled according to the selected heating curve. In reduced mode (setback mode and eco mode), the flow temperature is reduced by a parallel shift of the heating curve. The setting of the heating curve and the height of the parallel shift can be changed by your heating contractor.

Note

In weather-compensated mode without room influence, choosing temperature levels Comfort 1 to 3 or Party does not result in different room temperatures.

Commissioning

Time program or operating mode

You can choose between 3 preset time programs (P1 to P3) or select a permanent operating mode. You can change the switching times of the time programs individually. See page 18.

For each time phase, you can choose between the following preselected set room temperatures (temperature level):

- "COMFORT 1"
- "COMFORT 2"

- "COMFORT 3"
- "REDUCED TEMP"
- "FROST PROTECTION"

See page 18 for how to permanently change the set room temperatures.

If your room temperature controller acts on 2 heating circuits:

The set time program affects both heating circuits.

Selecting the time program or operating mode

Press the following keys:

1. Press **INFO**.
2. Press **MODE**.

3. Select the required time program with **<-/->**.
In the delivered condition, time program P1 is set.

4. **OK** to confirm

Preset time programs

Time program P1

Central heating in accordance with the following time program:

Monday to Friday

- 06:00 to 22:00 h:
Central heating with standard room temperature (Comfort 1)
- 22:00 to 06:00 h:
Central heating with reduced room temperature

Saturday and Sunday

- 07:00 to 23:00 h:
Central heating with standard room temperature (Comfort 1)
- 23:00 to 07:00 h:
Central heating with reduced room temperature

Time program P2

Central heating in accordance with the following time program:

Time program or operating mode (cont.)

Monday to Friday

- 06:00 to 08:00 h and 16:00 to 22:00 h:
Central heating with standard room temperature (Comfort 1)
- 08:00 to 16:00 h and 22:00 to 06:00 h:
Central heating with reduced room temperature

Saturday and Sunday

- 07:00 to 23:00 h:
Central heating with standard room temperature (Comfort 1)
- 23:00 to 07:00 h:
Central heating with reduced room temperature

Time program P3

Central heating in accordance with the following time program:

Monday to Friday

- 12:00 to 20:00 h:
Central heating with standard room temperature (Comfort 1)
- 20:00 to 12:00 h:
Central heating with reduced room temperature

Saturday and Sunday

- 07:00 to 22:00 h:
Central heating with standard room temperature (Comfort 1)
- 22:00 to 07:00 h:
Central heating with reduced room temperature

Constant operating modes

You can set the following operating modes:

- **"PERM COMFORT"**: Continuous operation with standard room temperature
- **"PERM REDUCED"**: Continuous operation with reduced room temperature
- **"FROST PROTECTION"**:

Frost protection mode:

- For room temperature-dependent operation: At room temperatures below + 6 °C.
- For weather-compensated operation: At outside temperatures below + 3 °C.

Time program or operating mode (cont.)

Changing the selected time program and set temperatures

You can set the following days and groups of days:

- Entire week (1 to 7)
- Monday to Friday (1 to 5)
- Saturday and Sunday (6 and 7)
- Individual days (1, 2, 3, ...7)

Changing existing time phases

Press the following keys:

1. **INFO**
2. **MODE**
3. Select "**SETTINGS**" with <-/->.
4. **OK** to confirm
5. Select "**PROGRAMMING**" with <-/->.
6. **OK** to confirm
7. Select the required program with <-/->.
8. **OK** to confirm
9. **EDIT**, "**CHANGE**" appears.
10. ■ **OK** to confirm, to change the switching time.
Days flash.
■ <-/-> for "**CLEAR**" and **OK**, to delete the switching time.
11. +/- for the required group of days or single day

12. **OK** to confirm
13. +/- for the required temperature level (e.g. Comfort 1)
14. **OK** to confirm
15. +/- for hour (start time)
16. **OK** to confirm
17. +/- for minute (start time)
18. **OK** to confirm
19. ■ **OK** to change further switching times.
■ **ESC** to exit programming.

Creating new time phases

Press the following keys:

1. **INFO**
2. **MODE**
3. Select "**SETTINGS**" with <-/->.
4. **OK** to confirm
5. Select "**PROGRAMMING**" with <-/->.
6. **OK** to confirm
7. Select the required program with <-/->.
8. **OK** to confirm

Time program or operating mode (cont.)

9. **NEW**
Days flash.
10. +/- for the required group of days or single day
11. **OK** to confirm
12. +/- for the required temperature level (e.g. Comfort 1)
13. **OK** to confirm
14. +/- for hour (start time)
15. **OK** to confirm
16. +/- for minute (start time)
17. **OK** to confirm
18. ■ **OK** to change further switching times.
■ **ESC** to exit programming.

Calling up switching times

Press the following keys:

1. **INFO**
2. **MODE**
3. Select "**SETTINGS**" with <-/->.
4. **OK** to confirm
5. Select "**PROGRAMMING**" with <-/->.
6. **OK** to confirm

7. Select the required program with <-/->.
8. **OK** to confirm
9. Press **NEXT** to call up the set switching times one after another.
10. **ESC** to exit programming.

Deleting the time program

Press the following keys:

1. **INFO**
2. **MODE**
3. Select "**SETTINGS**" with <-/->.
4. **OK** to confirm
5. Select "**PROGRAMMING**" with <-/->.
6. **OK** to confirm
7. Select the required program with <-/-> "**CLEAR P...**".
8. **OK** to confirm
9. Select "**CLEAR PROG**" with <-/->.
10. **OK** to confirm
Confirm appears.
11. **OK** to confirm
12. **ESC** to exit programming.

Central heating

Selecting the operating mode

You can choose between the following time programs and operating modes:

■ **"P 1" to "P 3"**

Alternating operation with standard and reduced room temperature according to the set switching times.

■ **"PERM COMFORT"**

Continuous comfort mode

■ **"PERM REDUCED"**

Continuous reduced mode

■ **"FROST PROTECTION"**

Continuous frost protection mode

See page 16 for how to select the operating mode.

Temporarily changing the room temperature

Temporarily changing the set room temperature

You can change the room temperature for a short time, regardless of the selected operating program. The change remains in force until the next operating program changeover.

1. Press **INFO** to access control mode.

2. ■ Room temperature-dependent mode or weather-compensated mode with room influence:
Use the rotary selector to set the required increase or decrease in the set room temperature in °C.
■ Weather-compensated mode without room influence:
Use the rotary selector to set a value from -5 to +5 for the required increase or decrease in the flow temperature. Value 1 means increasing or decreasing the flow temperature by 5 °C. This temporarily changes the room temperature.

Comfort mode

In comfort mode, the room temperature is regulated to a preselected set value (delivered condition: 23 °C). You can change the preselected set value. The setting remains in force until the next operating program changeover.

1. Press **INFO** to access control mode.

2. Press **PARTY**. The selected set room temperature appears.
3. Use the rotary selector to set the required increase or reduction of the set room temperature. **PARTY** is displayed.

Temporarily changing the room temperature (cont.)

Ending comfort mode early

1. Press **PARTY**. "**PARTY OFF**" appears.

Reduced mode

In reduced mode, the room temperature is regulated to a preselected set value (delivered condition: 17 °C). You can change the preselected set value. The setting remains in force until the next operating program changeover.

1. Press **INFO** to access control mode.
2. Press **ECO**. The selected set room temperature appears.

2. Press **OK** to end comfort mode.

3. Use the rotary selector to set the required increase or reduction of the set room temperature.

Ending reduced mode early

1. Press **ECO**. "**ECO OFF**" appears.
2. Press **OK** to end reduced mode.

Permanently changing the room temperature

You can permanently change the following preselected set room temperatures:

- **"COMFORT 1"** (delivered condition 21 °C)
- **"COMFORT 2"** (delivered condition 22 °C)
- **"COMFORT 3"** (delivered condition 23 °C)
- **"REDUCED TEMP"** (delivered condition 17 °C)
- **"FROST PROTECTION"** (delivered condition 6 °C)

Choose the preselected set room temperatures for the time phases in the time programs, for example.

Press the following keys:

1. **INFO**
2. **MODE**
3. Select **"SETTINGS"** with <-/->.
4. **OK** to confirm
5. Select **"TARGET TEMP"** with <-/->.
6. **OK** to confirm
"COMFORT 3" is displayed and the value flashes.



Central heating

Permanently changing the room temperature (cont.)

- Use +/- to change or press **OK** to move to the next setting (e.g. "COMFORT 1").
- OK** to confirm
The next setting appears.
- Change with +/- or press **ESC** to exit programming.

Changing the heating curve for weather-compensated operation

In weather-compensated operation, the room temperature is controlled according to a preset heating curve. If your room temperature controller acts on 2 heating circuits, a heating curve is preset for each heating circuit.

The heating curves show the relationship between the outside temperature and the boiler water temperature or flow temperature. The lower the outside temperature, the higher the boiler water or flow temperature. The heating curve is limited upwards by the maximum set flow temperature. The maximum set flow temperature can only be changed by your heating contractor.

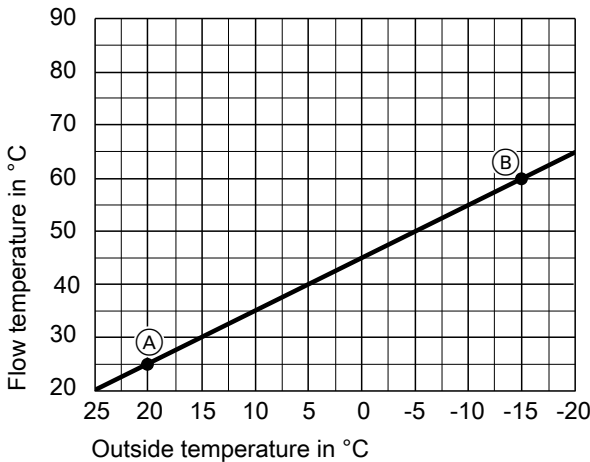

(A) Low end

(B) End point

Permanently changing the room temperature (cont.)

The line shows the curve for the standard room temperature. The delivered condition is shown.

The heating curve is changed with "**LOW END**", "**END POINT**" and "**SHIFT**", which influences the room temperature.

Shifting the heating curve means reducing the flow temperature for reduced mode. The value of "**SHIFT**" acts on both heating circuits.

Changing the heating characteristics to change the room temperature

Heating characteristics	Measure
The living space is too cold during the heating season	Set the " END POINT " to a higher value (e.g. 80 °C)
The living space is too hot during the heating season	Set the " END POINT " to a lower value (e.g. 70 °C)
The living space is too cold during spring/autumn and during the heating season	Set the " END POINT " and " LOW END " to a higher value (low end e.g. 30 °C; end point e.g. 80 °C)
The living space is too hot during spring/autumn and during the heating season	Set the " END POINT " and " LOW END " to a lower value (low end e.g. 20 °C; end point e.g. 70 °C)
The living space is too cold during spring/autumn	Set the " LOW END " to a higher value (e.g. 30 °C)
The living space is too hot during spring/autumn , but warm enough the heating season	Set the " LOW END " to a lower value (e.g. 20 °C)
The living space is too cold in reduced mode	Set the " SHIFT " to a lower value (e.g. 20 °C)
The living space is too hot in reduced mode	Set the " SHIFT " to a higher value (e.g. 30 °C)

Setting a heating curve

Press the following keys:

1. **INFO**
2. **MODE**
3. Select "**SETTINGS**" with <-/->.
4. **OK** to confirm

5. Select "**CONTROL**" with <-/->.

6. **OK** to confirm

7. Use <-/-> to select "**OT CONTROL**".



Central heating

Permanently changing the room temperature (cont.)

8. Use <-/-> to select the required setting:
 - – "LOW END" for heating circuit **without** mixer
 - "LOW END 2" for heating circuit **with** mixer
 - – "END POINT" for heating circuit **without** mixer
 - "END POINT 2" for heating circuit **with** mixer
 - – "SHIFT" for heating circuit **without** mixer
 - "SHIFT 2" for heating circuit **with** mixer
9. **OK** to confirm
10. Use +/- or the rotary selector to change the setting.
11. **OK** to confirm
12. **ESC** to exit the settings.

Changing the room temperature for a few days (holiday mode)

The holiday program starts on the set leaving day and ends on the set return day. The set time program is then active again.

Press the following keys:

1. **INFO**
2. **MODE**
3. Select "**SETTINGS**" with <-/->.
4. **OK** to confirm
5. Select "**HOLIDAY**" with <-/->.
6. **OK** to confirm
START HOLIDAY appears briefly, then the year flashes.
7. Change with +/-.
8. **OK** to confirm
The month flashes.
9. Change with +/-.
10. **OK** to confirm
The day flashes.
11. Set the day and hour in the same way, and press **OK** to confirm.
END HOLIDAY appears.
12. Set END HOLIDAY the same way.
13. "**FROST PROTECTION**" appears.
Set the required set temperature.
14. **OK** to confirm

Changing the room temperature for a few days... (cont.)**Stopping or interrupting the holiday program****Stopping the holiday program**

1. Press **OFF**.
"HOLIDAY OFF" appears.
2. **OK** to confirm
The holiday program is interrupted.

3. Select "**SETTINGS**" with <-/->.
4. **OK** to confirm
5. Select "**HOLIDAY**" with <-/->.
6. **OK** to confirm
"**REACTIVATE**" appears.

Reactivating the holiday program

1. **INFO**
2. **MODE**

7. **OK** to confirm
HOLIDAY appears.

DHW heating

Setting the time program and DHW temperature

You can set time phases for DHW heating:

- The DHW cylinder is heated during the set time phases when using a boiler with a DHW cylinder connected to it.
- If using a boiler with an integral instantaneous water heater, the DHW is kept at the set temperature during the set time phases.

Press the following keys:

1. **INFO**
2. **MODE**
3. Select "**SETTINGS**" with <-/->.
4. **OK** to confirm
5. Select "**PROGRAMMING**" with <-/->.
6. **OK** to confirm
7. Select "**HOT WATER**" with <-/->.
8. **OK** to confirm
9. **NEW**
Days flash.
10. +/- for the required group of days or single day
11. **OK** to confirm
12. +/- for the required set DHW temperature
13. **OK** to confirm
14. +/- for hour
15. **OK** to confirm
16. +/- for minute
17. **OK** to confirm
18. ■ **OK** to set further switching times.
■ **ESC** to exit programming.

Changing or deleting switching times

See page 18.

Temporarily changing the DHW temperature

You can change the DHW temperature for one hour.

1. Press **INFO** repeatedly until "**HW SETPOINT TEMP**" appears.
2. Select the required set DHW temperature with the rotary selector.

Time and date

Press the following keys:

1. **INFO**
2. **MODE**
3. Select "**SETTINGS**" with <-/->.
4. **OK** to confirm
5. Select "**TIME/DATE**" with <-/->.
6. **OK** to confirm
7. Press +/- to make the required setting.
8. **OK** to confirm and to move to the next setting.
9. **ESC** to exit programming.

Summer/wintertime

Press the following keys:

1. **INFO**
2. **MODE**
3. Select "**SETTINGS**" with <-/->.
4. **OK** to confirm
5. Select "**TIME/DATE**" with <-/->.
6. Press **OK** repeatedly until "**SU/WI RULE**" appears.
7. Press <-/-> to select the required setting.
8. **OK** to confirm
9. **ESC** to exit programming.

Further settings

You can make further settings under "**OPTIONS**". For further information on settings, see the following chapters.

Press the following keys:

1. **INFO**
2. **MODE**
3. Select "**SETTINGS**" with <-/->.
4. **OK** to confirm
5. Select "**OPTIONS**" with <-/->.
6. **OK** to confirm
7. Press <-/-> to select the required setting.
See following chapter.
8. **ESC** to exit programming.



Further adjustments

Setting the language

1. Confirm **"LANGUAGE"** with **OK**.
2. +/- for the required language
3. **OK** to confirm

Changing the default display

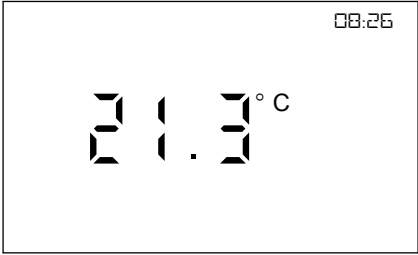
1. Confirm **"DISPLAY"** with **OK**.
2. +/- for the required display version

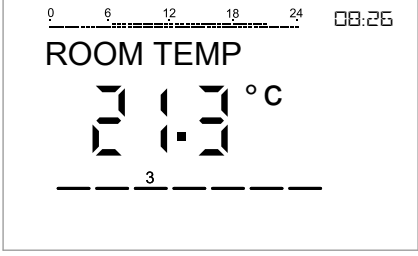
Setting	Display version
1	 The LCD display shows the temperature 21.3°C in large digits. In the top right corner, the time 08:26 is displayed.
2	 The LCD display shows the time 12:00 in large digits. In the top right corner, the temperature 21.3°C is displayed.
3	 The LCD display shows the text "ROOM TEMP" at the top. Below it is the temperature 21.3°C. At the bottom, there is a scale with markings at 0, 6, 12, 18, and 24, and the number 3 is positioned below the scale line.

3. **OK** to confirm

Setting the contrast

You can change the display contrast in stages.

1. Confirm "**CONTRAST**" with **OK**.
2. Use +/- to set the required value (0 to 15).
3. **OK** to confirm

Locking out controls (key lock)

You can lock out the controls by switching on key lock.

1. Confirm "**KEY LOCK**" with **OK**.
2. Press +/- to select "**WITH KEY-LOCK**" or "**NO KEYLOCK**".
3. **OK** to confirm
The display then shows only "**KEY LOCK**" and a key symbol.

Temporarily interrupting or unlocking key lock

Press and hold **INFO** for longer than 3 seconds.

You can then temporarily operate the device or unlock the key lock. See above.

Changing the display format of fault messages

1. Press **OK** to confirm the "**ERROR FORMAT**".
2. Press +/- to select "**HEXADECIMAL**".
Do not adjust "**DECIMAL**".
3. **OK** to confirm

Returning all settings to their delivered condition

All settings made after commissioning will be lost.

1. Confirm "**FACTORY SET**" with **OK**.
"**CONFIRM**" appears.
2. **OK** to confirm

Checks

Checking information

You can check the following information with **INFO**:

- Current outside temperature
- Active time program
- Fault messages
- Set flow temperature

- Actual flow temperature
- Date and time

Press **INFO** repeatedly until the required information appears.

Rooms are too cold

Cause	Remedy
The room temperature controller is incorrectly set.	Check the settings and correct if required: <ul style="list-style-type: none"> ■ Program ■ Room temperature ■ Time

Note

For further causes, see the boiler operating instructions

Rooms are too hot

Cause	Remedy
The room temperature controller is incorrectly set.	Check the settings and correct if required: <ul style="list-style-type: none"> ■ Program ■ Room temperature ■ Time

Note

For further causes, see the boiler operating instructions

What to do if...

Carrying out a reset

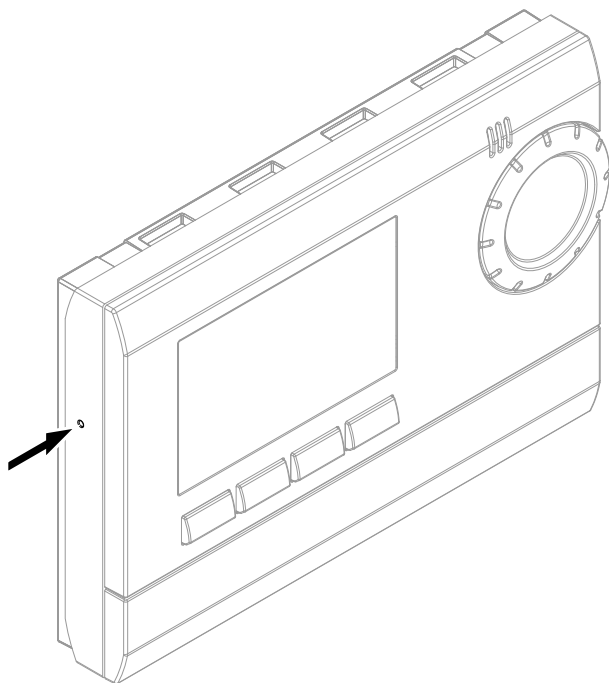

Press the reset button with a suitable instrument.

Cleaning

This device can be cleaned with a commercially available domestic cleaning agent. Never use any scouring agents.

Menu structure in setting mode (MODE)

MODE	
	P1 ACTIVE
	ACTIVATE P2
	P2 ACTIVE
	ACTIVATE P3

PERM COMFORT
PERM REDUCED
FROST PROTECTION
SETTINGS

Menu structure in settings

SETTINGS

TARGET TEMP	
	COMFORT 3
	COMFORT 2
	COMFORT 1
	REDUCED TEMP
	FROST PROTECTION
TIME/DATE	
	HOUR
	MINUTE
	YEAR
	MONTH
	DAY
	SU/WI RULE
PROGRAMMING	
	PROG P1
	PROG P2
	PROG P3
	HOT WATER
	CLEAR PROG

HOLIDAY	
	START HOLIDAY
	YEAR
	MONTH
	DAY
	HOUR
	END HOLIDAY
	FROST PROTECTION
OPTIONS	
	LANGUAGE
	DISPLAY
	LCD BACKLIGHT
	CONTRAST
	KEY LOCK
	ERROR FORMAT
	FACTORY SET
SERVICE	
	WALL COMP
	OPTIMISE
	EXT INPUT
	DEVICE TYPE
	CONTROL
	SERVICE
	CHIMNEY SWEEP
	INFO
	TSP-PARAMETER

Menu structure in settings (cont.)**Note**

Menu point TSP-PARAMETER only appears if the room temperature controller acts on heating circuits (mixer extension kit).

Keyword index

Keyword index

C

Checks.....	30
Cleaning.....	33
Contrast, setting.....	29
Controls.....	13
– Locking out.....	29
Controls and display elements.....	12

D

Default display, changing.....	28
DHW.....	26
DHW temperature	
– Changing.....	26
Display.....	13
Display screen.....	13

H

Heating characteristics.....	23
Heating curve	
– Explanation.....	22
Holiday mode.....	24

K

Key lock.....	29
---------------	----

L

Language, setting.....	28
------------------------	----

O

Operating mode.....	16, 20
Operating mode, selecting.....	20

R

Reset.....	32
Room temperature	
– Changing.....	20, 21
– Changing for a few days.....	24
– Permanently changing.....	21
– Temporarily changing.....	20

S

Summer/wintertime.....	27
Switching times.....	16
– Changing.....	18

T

Temperatures	
– Changing.....	18
Temperatures, checking.....	30
Time and date.....	27
Time program.....	16
Troubleshooting.....	31







Your contact

Contact your local contractor if you have any questions about your system or wish to arrange maintenance or repair work. You can find local contractors on the internet at www.viessmann.de.



Viessmann Werke GmbH & Co. KG
D-35107 Allendorf
Telephone: +49 6452 70-0
Fax: +49 6452 70-2780
www.viessmann.com

Viessmann Limited
Hortonwood 30, Telford
Shropshire, TF1 7YP, GB
Telephone: +44 1952 675000
Fax: +44 1952 675040
E-mail: info-uk@viessmann.com

5837779 Subject to technical modifications.