

Operating instructions for the system user

VIESMANN

Heating system with weather-compensated control unit
Vitotronic 200, type KO1B, KO2B or KW6B

VITOTRONIC 200





Safety instructions

For your safety

 Please follow these safety instructions closely to prevent accidents and material losses.

Safety instructions explained

 **Danger**
This symbol warns against the risk of injury.

 **Please note**
This symbol warns against the risk of material losses and environmental pollution.

Note

Details identified by the word "Note" contain additional information.

Target group

These operating instructions are designed for heating system users.

This appliance has **not** been designed to be operated by individuals (including children) with limited physical, sensory or mental capacities or who are lacking in the appropriate experience and/or knowledge, unless they are supervised by a person with responsibility for their safety or were instructed by that person in the operation of this appliance.

 **Please note**
Children must be supervised.
Ensure that children never play with the appliance.

 **Danger**
Incorrectly executed work on the heating system can lead to life-threatening accidents.

- Work on gas installations must only be carried out by a registered gas fitter.
- Work on electrical equipment must only be carried out by a qualified electrician.

If you smell gas

 **Danger**
Escaping gas can lead to explosions which may result in serious injury.

- Do not smoke. Prevent naked flames and sparks. Do not switch lights or electrical appliances on or off.
- Close the gas shut-off valve.
- Open windows and doors.
- Evacuate any people from the danger zone.
- Notify your gas or electricity supplier and your local heating contractor from outside the building.
- Shut off the electricity supply to the building from a safe place (outside the building).

If you smell flue gas

 **Danger**
Flue gas can lead to life-threatening poisoning.

- Shut down the heating system.
- Ventilate the installation site.
- Close all doors in the living space.

In case of fire

 **Danger**
If there is a fire, there is a risk of burns and explosion.

- Shut down the heating system.
- Close shut-off valves in the fuel supply lines.
- Use a tested fire extinguisher, class ABC.

What to do if the heating system develops faults

 **Danger**
Fault messages indicate faults in the heating system. If faults are not rectified, they can have life threatening consequences.
Do not acknowledge fault messages several times in quick succession. Inform your heating contractor so the cause can be analysed and the fault rectified.

Installation room conditions

 **Danger**
Sealed vents result in a lack of combustion air. This leads to incomplete combustion and the formation of life threatening carbon monoxide. Never cover or close existing vents.
Do not make any subsequent modifications to the building characteristics that could affect safe operation (e.g. cable/pipework routing, cladding or partitions).

 **Danger**
Easily flammable liquids and materials (e.g. naphtha, solvents, cleaning agents, paints or paper) can cause deflagration and fire. Never store or use such materials in the boiler room or in direct proximity to the heating system.

 **Please note**
Incorrect ambient conditions can lead to heating system damage and can put safe operation at risk.

- Ensure ambient temperatures are above 0 °C and below 35 °C.
- Prevent air contamination by halogenated hydrocarbons (e.g. as contained in paints, solvents or cleaning fluids) and excessive dust (e.g. through grinding/polishing work).
- Avoid continuously high humidity levels (e.g. through frequent drying of washing).

For your safety (cont.)**Extractors**

Operating appliances that extract air to the outside (cooker hoods, extractors, air conditioning units, etc.) can create negative pressure. If the boiler is operated at the same time, this can lead to reverse flow of the flue gas.

**Danger**

The simultaneous operation of the boiler and appliances that extract air to the outside can result in life threatening poisoning due to reverse flow of the flue gas.

Take suitable steps to ensure an adequate supply of combustion air. If necessary, contact your heating contractor.

Auxiliary components, spare and wearing parts**Please note**

Components not tested with the heating system may lead to damage to the heating system, or may affect its functions.

Installation or replacement work must only be carried out by qualified personnel.

1. Introductory information	Intended use	6
	Commissioning	6
	Terminology	6
	Your system is preset at the factory	6
	Energy saving tips	7
	Tips for more comfort	7
2. Operation	Opening the control unit	9
	Programming unit	10
	■ "Help" menu	10
	■ Symbols	11
	Standard menu	11
	Extended menu	12
	How to use the controls	12
	Operating program	15
	■ Operating programs for central heating, DHW, frost protection	15
	■ Special operating programs	15
	Time program	15
	■ Setting a time program using central heating as an example	16
	■ Setting the time program efficiently	16
	■ Deleting time phases	17
3. Start-up/shutdown	Starting the heating system	18
	■ Controls with the cover open	18
	Shutting down the heating system	19
	■ With frost protection monitoring	19
	■ Without frost protection monitoring (shutdown)	20
4. Central heating	Room temperature	21
	■ Setting the standard room temperature for central heating	21
	■ Setting the reduced room temperature for central heating	21
	Operating program	21
	■ Setting the operating program for central heating	21
	Time program	21
	■ Setting the time program for central heating	22
	Heating curve	22
	■ Setting the heating curve	22
	Switching off central heating	22
	Comfort function "Party mode"	23
	■ Setting "Party mode" for central heating	23
	■ Cancelling "Party mode"	23
	Energy saving function "Economy mode"	23
	■ Setting "Economy mode" for central heating	23
	■ Cancelling "Economy mode"	24
	Energy saving function "Holiday program"	24
	■ Setting the "Holiday program" for central heating	24
	■ Cancelling or deleting the "Holiday program"	25
5. DHW heating	DHW temperature	26
	Operating program	26
	■ Setting the operating program for DHW heating	26
	Time program	26
	■ Setting the time program for DHW heating	26
	■ DHW heating once, no longer in the time program	26
	■ Setting the time program for the DHW circulation pump	27
	Switching off DHW heating	27
6. Further adjustments	Setting the display contrast	28
	Setting the display brightness	28
	Entering names for the heating circuits	28

Index (cont.)

	Setting the preferred heating circuit for the standard menu	29
	Setting the time and date	29
	Language selection	29
	Setting the temperature unit (°C/°F)	29
	Restoring factory settings	29
7. Scanning	Scanning information	31
	Scanning the service messages	31
	Scanning fault messages	32
8. Emissions test mode	34
9. What to do if...	Rooms are too cold	35
	Rooms are too hot	36
	There is no hot water	36
	The DHW is too hot	37
	△ flashes and "Fault" is displayed	37
	✂ flashes and "Service" is displayed	37
	"Controls locked out" is displayed	37
	"External hook-up" is displayed	37
	"External program" is displayed	38
10. Repair work	39
11. Ordering fuel oil	Fuel oil quality	40
	Fuel oil additives	40
	Combustion improvers	40
	Biofuels	40
12. Appendix	Overview of extended menu	41
	Calling up options under "Information"	41
	Terminology	43
13. Keyword index	47

Introductory information

Intended use

The appliance is only intended to be installed and operated in sealed unvented heating systems that comply with EN 12828, with due attention paid to the associated installation, service and operating instructions. It is only designed for the heating of water that is of potable water quality.

Intended usage presupposes that a fixed installation in conjunction with permissible, system-specific components has been carried out.

Commercial or industrial usage for a purpose other than heating the building or DHW does not comply with regulations.

Any usage beyond this must be approved by the manufacturer for the individual case.

Incorrect usage or operation of the appliance (e.g. the appliance being opened by the system user) is prohibited and results in an exclusion of liability. Incorrect usage also occurs if the components in the heating system are modified from their intended function (e.g. if the flue gas and ventilation air paths are sealed).

Commissioning

The commissioning and matching of the control unit to local conditions and building characteristics, as well as instructing the user in the operation of the system, must be carried out by your heating contractor.

As the user of new combustion equipment, you may be obliged to notify your local flue gas inspector of the installation [check local regulations]. Your local flue gas inspector will also inform you [where appropriate] about work he may be required to perform on your combustion equipment (e.g. regular checks, cleaning).

Terminology

To provide you with a better understanding of the functions of your Vitotronic control unit some terminology is explained.

The terms are marked as follows:



Further information can be found in chapter "Terminology" in the appendix.

Your system is preset at the factory

Your heating system is preset at the factory and is therefore ready for operation:

Central heating

- Between **06:00 and 22:00 h**, the rooms are heated to 20 °C "**Set room temperature**" (standard heating mode).
- Between **22:00 and 06:00 h**, the rooms are heated to 3 °C "**Set reduced room temp**" (reduced room temperature, frost protection).

DHW heating

- Between **05:30 and 22:00 h**, DHW is heated to 50 °C "**Set DHW temperature**". Any installed DHW circulation pump is ON.
- Between **22:00 and 05:30 h**, the DHW cylinder is not reheated. Any installed DHW circulation pump is OFF.

Note

If DHW heating began before 22:00 h, it is stopped.

Frost protection

- Your boiler and DHW cylinder are protected against frost.

Wintertime/summertime changeover

- This changeover is automatic.

Your system is preset at the factory (cont.)

Date and time

- The date and time were set by your heating contractor.

Your heating contractor can make further settings for you during commissioning.

You can change the settings individually at any time to suit your requirements.

Power failure

All settings are saved if there is a power failure.

If the heating system has been out of use for a prolonged period, reset the date and time.

Energy saving tips

Central heating

- **Standard room temperature** ("Set room temperature", see page 21):
Never overheat your home. Every degree of room temperature reduction saves up to 6 % on your heating bills.
Never set your standard room temperature higher than 20 °C.
- **Time program** (see page 15):
Heat your rooms to the standard room temperature during the day and the reduced temperature at night. Set the time program for this.
- **Operating program**:
If you do not require central heating, select one of the following operating programs:
 - **"Only DHW"** (see page 26):
If you require no heating for your home in summer, but you need hot water.
 - **"Standby mode"** (see page 19):
If you don't need to heat your home and don't need hot water for longer periods.
- **Short absence** (see page 23):
Reduce the room temperature if you are going shopping, for example. For this, select **"Economy mode"**.
- **Holidays** (see page 24):
If you are going away, select the **"Holiday program"**:
The room temperature will be reduced, and DHW heating will be turned off.

Ventilation:

To ventilate, close the thermostatic valves and open the windows fully for a short time.

Roller shutters:

Close roller shutters (where installed) at dusk.

Thermostatic valves:

Ensure that thermostatic valves are properly set.

Radiators:

Never cover radiators or thermostatic valves.

DHW heating

- **DHW circulation pump** (see page 27):
Only activate the DHW circulation pump for periods in which DHW is regularly drawn off. Set the time program for this.
- **DHW consumption**:
Consider showering instead of running a bath. A shower generally uses less energy than a full bath.

For additional energy saving functions of the Vitotronic control unit, please contact your heating contractor.

Tips for more comfort

Central heating

- **Standard room temperature** ("Set room temperature", see page 21):
You can select your individual preferred temperature at any time in the standard menu.
- **Preferred heating circuit** (see page 29):
If your heating system consists of several heating circuits, you can make the most important adjustments for a preferred heating circuit directly via the standard menu.

Time program

(see page 15):
Make use of the time program. In the time program, you can set time phases with different room temperatures, for example different temperatures for day and night time.

Tips for more comfort (cont.)

- **Heating curve** (see page 22):
The heating curve enables you to individually adjust the heating system to the actual heat demand in your home. If set correctly, your preferred temperature will be achieved all year round.
- **"Party mode"** (see page 23):
Select **"Party mode"** if you want to heat your home to a temperature that is different from that dictated by the time program.
Example: The time program determines that in the evening, your home is heated to a reduced room temperature, but you have visitors staying into the evening.

DHW heating

- **Time program** (see page 15 and 27):
Use the time program for DHW heating.
Use the time program for the DHW circulation pump.
During the selected time phases, DHW will be available at the draw-off points at the required temperature.

Opening the control unit

The control unit may look different depending on the control unit type.

Vitotronic 200, type KO1B

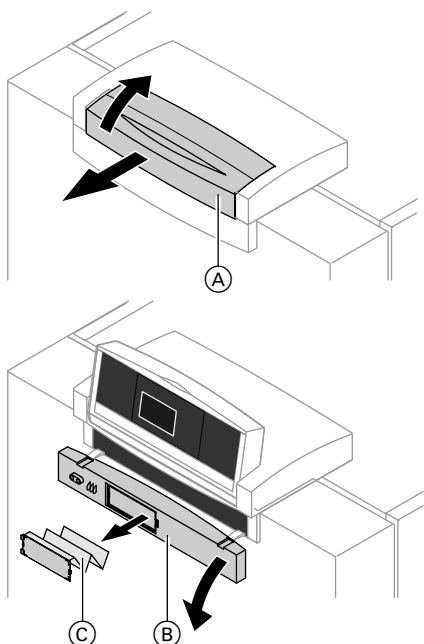

Fig. 1

- (A) Top part of control unit with programming unit
- (B) Cover flap
- (C) Short operating guide on the inside of the cover

Vitotronic 200, type KO2B

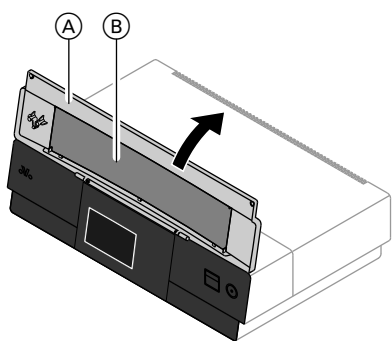

Fig. 2

- (A) Cover flap
- (B) Short operating guide on the inside of the cover

Opening the control unit (cont.)

Vitotronic 200, type KW6B

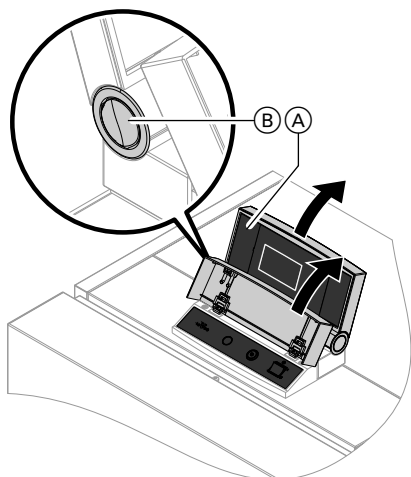

Fig. 3

- (A) Top part of control unit with programming unit
- (B) Pushbutton for changing the angle

Note

You will find a short operating guide in the "Technical documentation".

Programming unit

You can change any settings on your heating system centrally at the programming unit of the control unit. If remote control units are installed in your rooms, you can also adjust the settings at the remote control units.



Remote control operating instructions

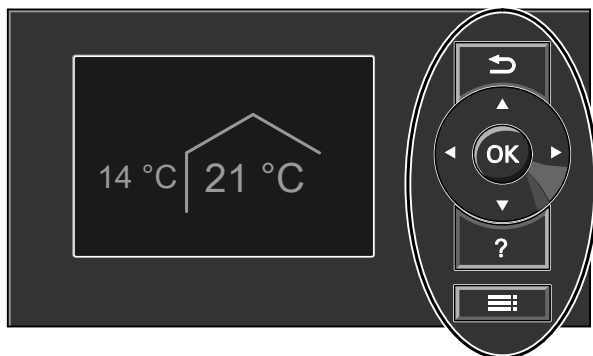

Fig. 4

- Takes you to the previous step in the menu or cancels a setting that has been started.
- Cursor keys
To scroll in the menu or to set values.

- OK** Confirms your selection or saves the setting.
- ?** Calls up "**Help**" (see following chapter) or additional information on the selected menu.
- ≡** Calls up the extended menu.

Two **control levels** are available:

- The standard menu: See page 11.
- The extended menu: See page 12.

Note

The **screen saver** is activated if you have not made any adjustments on the programming unit for a few minutes (see page 13).

"Help" menu

Displays explanations about operation in the form of a short guide.

Programming unit (cont.)

Call up the short guide as follows:

- If the screen saver is active (see page 13):
Press **?**.
- From anywhere in the menu:
Keep pressing the **↩** key until the standard menu is shown (see page 11).
Press **?**.

Symbols

These symbols are not always displayed, but appear subject to the system version and the operating state.

Indicators:

- ❄ Frost protection enabled
- ☀ Central heating to standard room temperature
- ☾ Central heating with reduced room temperature
- ☹ Party mode enabled
- 🏠 Economy mode enabled
- ☀ In conjunction with a solar thermal system:
Solar circuit pump is running

Heating circuits:

Heating circuit ...

Heating programs:

🏠, 🏠, 🏠:

For an explanation of the symbols, see page 15.

Messages:

- ⚠ Fault
- 🔧 Service

Standard menu

The following settings for the preferred heating circuit (Ⓓ) can be called up and adjusted in the standard menu:

- Set room temperature
- Operating program

Call up the standard menu as follows:

- If the screen saver is active (see page 13):
Press **OK**.
- If you are in the extended menu (see page 12):
Keep pressing the **↩** button until the standard menu appears.

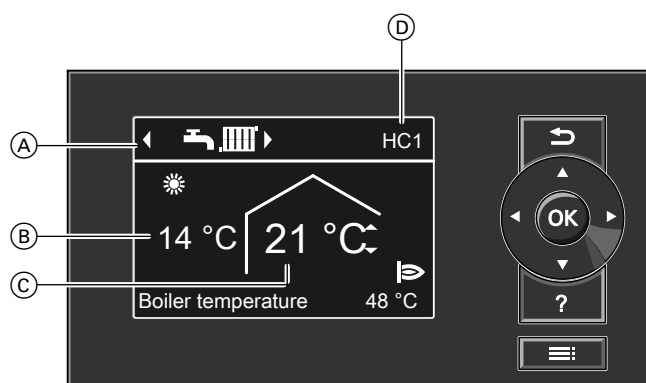

Fig. 5

- Ⓐ Operating program for the preferred heating circuit (Ⓓ)
- Ⓑ Current outside temperature
- Ⓒ Set room temperature for the preferred heating circuit (Ⓓ)
- Ⓓ Preferred heating circuit (see page 29)
Not displayed if only **one** heating circuit is installed.

Standard menu (cont.)

Note

- Settings for the preferred heating circuit can also be adjusted in the **extended menu** (see page 12).
- The settings for any other connected heating circuits can **only** be adjusted in the extended menu.
- Your heating contractor can block the operation of the standard menu. In such cases, you will not be able to make adjustments in either the standard menu or in the extended menu.

Setting the standard room temperature for the preferred heating circuit

Press the following keys:

▲/▼ for the required value.
OK to confirm.

Setting the operating program for the preferred heating circuit

Press the following keys:

◀▶ for the required operating program.
OK to confirm.

Extended menu

In the extended menu, **all** settings for the Vitotronic control unit's range of functions can be called up and adjusted, including for example adjustments to the holiday program and time programs. The menu overview can be found on page 41.

Note

Your heating contractor can block operation for the extended menu. In this case, you can **only** call up service and fault messages.

Call up the extended menu as follows:

- If the screen saver is active (see page 13): Press **OK** and then ≡.
- From anywhere in the menu: Press ≡.

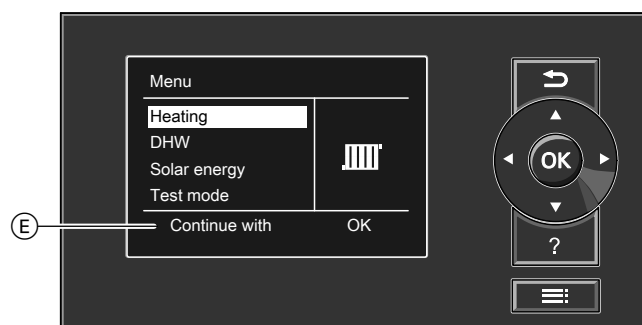

Fig. 6

Ⓔ Dialogue line

How to use the controls

The **screen saver** will become active if you have not adjusted any settings on the programming unit for a few minutes. The display brightness is reduced.

How to use the controls (cont.)

Screen saver

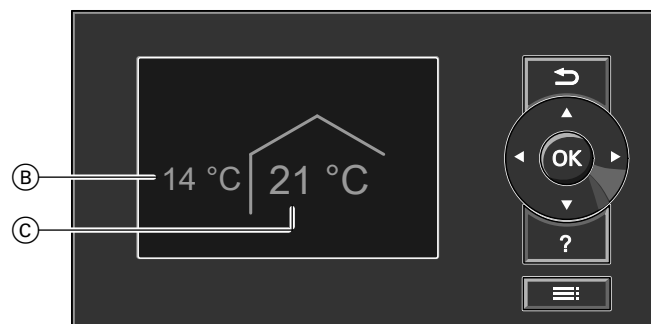

Fig. 7

- Ⓑ Current outside temperature
- Ⓒ Set room temperature

1. Press **OK**. This takes you to the standard menu (see page 11).
2. Press **☰**. This takes you to the extended menu (see page 12).
The selected menu point is highlighted in white.
Dialogue line Ⓔ (see diagram on page 12) shows the necessary instructions.

Adjustments to the central heating can be made for **every** heating circuit. It is therefore necessary to select the respective heating circuit **prior** to making any adjustments (e.g. room temperature).

The following diagram shows how to make adjustments, using the set room temperature as an example. The diagram shows the adjustment without and with selection of the heating circuit, as well as different dialogue lines.

How to use the controls (cont.)

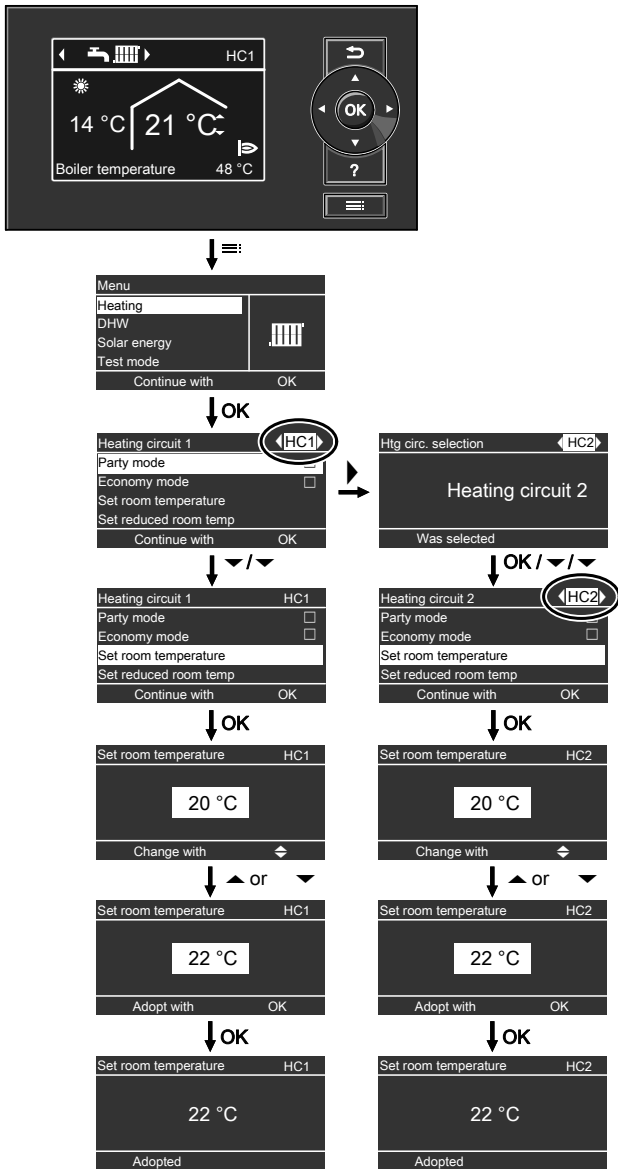





Fig. 8

Operating program

Operating programs for central heating, DHW, frost protection

Symbol	Operating program	Function
Central heating and DHW heating		
	"Heating and DHW"	<ul style="list-style-type: none"> The rooms of the selected heating circuit are heated in accordance with the room temperature and time program specified (see chapter "Central heating"). DHW is heated in accordance with the DHW temperature and time program specified (see chapter "DHW heating").
DHW heating		
	"Only DHW"	<ul style="list-style-type: none"> DHW is heated in accordance with the DHW temperature and time program specified (see chapter "DHW heating"). No central heating. Frost protection enabled.
Frost protection		
	"Standby mode"	<ul style="list-style-type: none"> No central heating. No DHW heating. Frost protection for the boiler and the DHW cylinder is active.

Special operating programs

Display in the standard menu

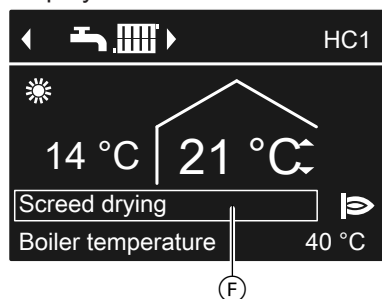

Fig. 9

Special operating programs (F):

- "Screed drying"**
 This function is activated by your heating contractor. Your screed is dried in line with a set time program suitable for the building material (temperature:time profile). Your settings for central heating have no effect for the duration of the screed drying.
- "External hook-up"**
 Your heat pump control unit is regulated by a higher control unit.

- "External program"**
 The operating program was changed by a communications interface (e.g. Vitocom 100).
- "Holiday program"**
 See page 24.

Note

In the extended menu, you can call up the set operating program under **"Information"** (see page 31).

Time program

The following explains how to input the settings for a time program. The special features of each individual time program are assigned to the relevant chapters.

Time program (cont.)

You can set up a time program for the following functions:





- Central heating (see page 21)
- DHW heating (see page 26)
- DHW circulation pump (see page 27)

In the time program, divide the day into sections. These are called **time phases**. It is for you to decide what happens in these time phases. For example, they could specify when your rooms will be heated to standard room temperature.

- You can set the time program **individually**, to be the same, or different, for every day of the week.
- You can select up to 4 time phases per day.
- For each time phase you select the start and end points. The selected time phase is illustrated by a white bar on the time chart. The length of the bar reflects the length of time.
- In the extended menu, you can call up the time programs under **"Information"** (see page 31).

Setting a time program using central heating as an example

Extended menu:

1. 
2. **"Heating"**
3. Poss.   for the required heating circuit.
4. **"Heating time program"**
5. Select part of the week or a day.
6. Select a time phase 1 to 4. The selected time phase is illustrated by a white bar on the time chart.
7. Set the start and end points for the relevant time phase. The length of the white bar in the time diagram is adjusted accordingly.
8. Press  to exit the menu.

Note

If you want to terminate a time phase setting process prematurely, keep pressing  until the required display appears.

Example of time phases within the time program for central heating

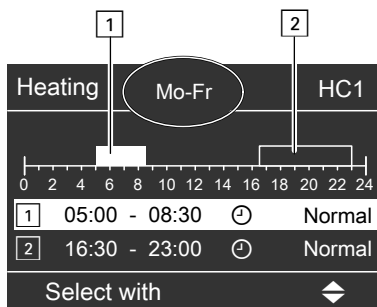

Fig. 10

- Time program for the following part of the week: **"Monday-Friday" ("Mo-Fr")**
- Time phase 1: 05:00 to 08:30 h
- Time phase 2: 16:30 to 23:00 h

In between these time phases the system heats to a reduced temperature.

Setting the time program efficiently

If you would like to set a different time program for just one day of the week, proceed as follows:

Time program (cont.)

Example: You want to set a different time program for Monday:

1. Select the period **"Monday-Sunday"** and set the time program.

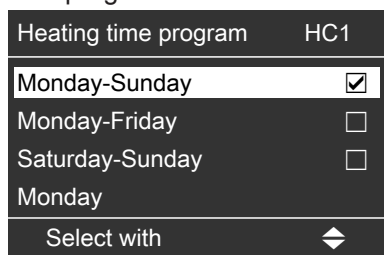

Fig. 11

Note

The tick is always set at the sections of the week with identical time phases.

Factory setting: Same for all days of the week, therefore **"Monday-Sunday"** is ticked.

2. Then select **"Monday"** and adjust the time program for that day.

Note

The **"Saturday-Sunday"** part of the week is ticked because the set time phases correspond only to this part of the week.

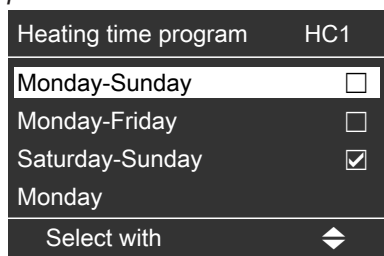

Fig. 12

Deleting time phases

- Set the time for the end point to the same time that was set for the start point.

Or

- For the start point, select a time prior to 00:00 h.

The display shows the selected time phase as

"- : - : -".



Fig. 13

Starting the heating system

Controls with the cover open

For flap, see page 9.

Vitotronic 200, type KO1B

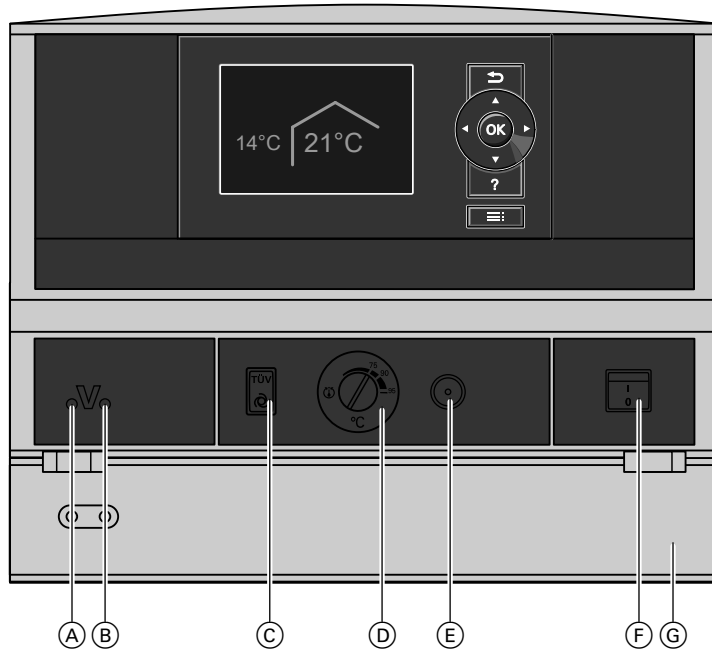

Fig. 14

- (A) Fault indicator (red)
- (B) On indicator (green)
- (C) TEST key
(only for service purposes)
- (D) Temperature controller
- (E) Excess temperature reset
- (F) ON/OFF switch
- (G) Cover flap

Vitotronic 200, type KO2B

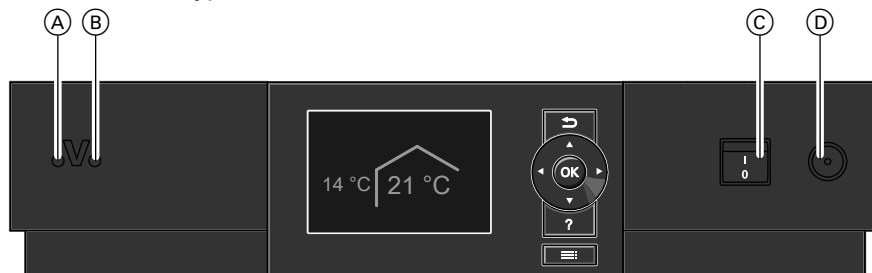

Fig. 15

- (A) Fault indicator (red)
- (B) On indicator (green)
- (C) ON/OFF switch
- (D) Excess temperature reset

Starting the heating system (cont.)

Vitotronic 200, type KW6B

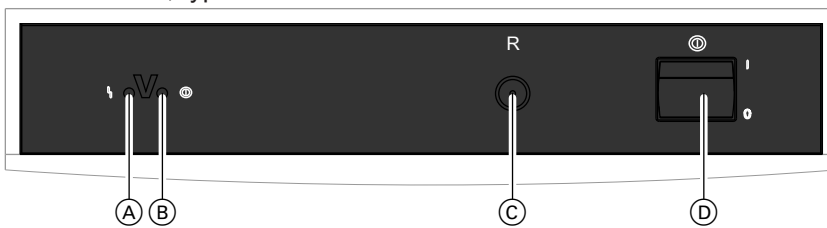

Fig. 16

- | | |
|---------------------------|-------------------|
| (A) Fault indicator (red) | (C) Reset button |
| (B) On indicator (green) | (D) ON/OFF switch |

Ask your heating contractor about the following:

- Boiler type and relevant control unit type
- Level of the required system pressure
- Position of the pressure gauge, shut-off valve, gas shut-off valve, ventilation apertures

1. Check the heating system pressure at the pressure gauge. If the pressure of the heating system is too low, top up the water or notify your heating contractor.
2. In boilers for **open** flue operation: Check that the ventilation apertures of the installation room are open and unrestricted.

Note

With open flue operation, the combustion air is drawn from the installation room.

3. Open the shut-off valves in the oil lines (at the tank and filter) or open the gas shut-off valve.
4. Switch ON the power supply, e.g. at a separate MCB/fuse or a mains isolator.
5. Switch ON the ON/OFF switch (see pages 18 and 19).
After a short time, the standard menu is displayed (see page 11) and the green ON indicator illuminates. Your heating system and, if installed, your remote control unit are now ready for use.

Shutting down the heating system

With frost protection monitoring

For **every** heating circuit, select the operating program "**Standby mode**".

- No central heating.
- No DHW heating.
- Frost protection for the boiler and the DHW cylinder is active.

For the preferred heating circuit

Standard menu

1. ▶/◀ for the operating program "**Standby mode**"
2. **OK** to confirm.

For all heating circuits

Extended menu

1. ≡
2. "**Heating**"

3. Poss. ▶/◀ for the required heating circuit.
4. "**Heating program**"
5. "**Standby mode**"

Note

The circulation pumps are briefly started every 24 hours to prevent them from seizing up.

End the heating program "Standby mode"

Select another heating program.

Shutting down the heating system (cont.)

Without frost protection monitoring (shutdown)

1. Switch OFF the ON/OFF switch (see pages 18 and 19).
2. Close the shut-off valves in the oil lines (at the tank and filter) or close the gas shut-off valve.
3. Isolate the heating system from its main power supply, e.g. at the separate MCB/fuse or a mains isolator.



Please note

- If outside temperatures of below 3 °C are expected, please take appropriate measures to protect the heating system from frost. If necessary, contact your heating contractor.

Information on a prolonged shutdown

- *Circulation pumps may seize up as they are not supplied with power.*
- *It may be necessary to reset the date and time (see page 29).*

Room temperature



Further information can be found in chapter "Terminology" in the appendix.

Setting the standard room temperature for central heating

Factory setting: 20 °C

For the preferred heating circuit

Standard menu

1. ▲/▼ for the required value.
2. **OK** to confirm.

For all heating circuits

Extended menu

- 1.
2. **"Heating"**
3. Poss. ◀▶ for the required heating circuit.
4. **"Set room temperature"**
5. Set the required value.

Setting the reduced room temperature for central heating

Factory setting: 3 °C

Extended menu

- 1.
2. **"Heating"**
3. Poss. ◀▶ for the required heating circuit.
4. **"Set reduced room temp"**
5. Set the required value.

Central heating to this temperature:

- Between the time phases for standard heating mode (see page 22).
- In the holiday program (see page 24).

Operating program



Further information can be found in chapter "Terminology" in the appendix.

Setting the operating program for central heating

For the preferred heating circuit

Standard menu

1. ◀▶ for the operating program:
"Heating and DHW"
Or
"Heating"
2. **OK** to confirm.

3. Poss. ◀▶ for the required heating circuit.
4. **"Heating program"**
5. For example **"Heating and DHW"**
Or
"Heating"

For information on the operating programs, see page 15.

For all heating circuits

Extended menu

- 1.
2. **"Heating"**

Time program



Further information can be found in chapter "Terminology" in the appendix.



Central heating

Time program (cont.)

Setting the time program for central heating

Factory setting: **One** time phase from 6:00 to 22:00 h for every day of the week.

Extended menu:

1. 
2. **"Heating"**
3. Poss.   for the required heating circuit.
4. **"Heating time program"**
5. Set the required time phases.
Procedure for setting a time program, see page 15.

Note

When setting, bear in mind that your heating system requires some time to heat the rooms to the required temperature.

Heating curve





Further information can be found in chapter "Terminology" in the appendix.

Setting the heating curve

Factory setting:

- **"Slope"**: 1.4
- **"Level"** of the heating curve: 0

Extended menu:

1. 
2. **"Heating"**
3. Poss.   for the required heating circuit.
4. **"Heating curve"**
5. **"Slope"** or **"Level"**
6. Set the required value.

Note

Tips on when and how to change the heating curve slope and level are displayed by pressing ?.

Example: Changing the heating curve slope to 1.5

A graph clearly shows the change in the heating curve as soon as you alter the value for the slope or level.

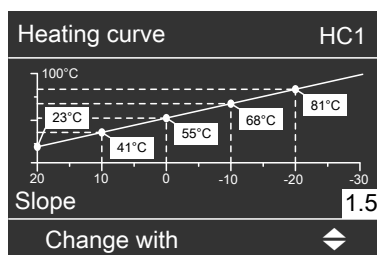



Fig. 17

Depending on various outside temperatures (shown on the horizontal axis), the assigned set flow temperatures for the heating circuit are highlighted in white.

Switching off central heating



For the preferred heating circuit

Standard menu

1.   for the operating program:
 - **"Only DHW"** (no central heating)
Or
 - **"Standby mode"** (frost protection active)
2. **OK** to confirm.

For all heating circuits



Extended menu

1. 
2. **"Heating"**
3. Poss.   for the required heating circuit.
4. **"Heating program"**
5. ■ **"Only DHW"** (no central heating)
Or
 - **"Standby mode"** (frost protection active)

Comfort function "Party mode"

Setting "Party mode" for central heating

Extended menu

1. 
2. "Heating"
3. Poss.   for the required heating circuit.
4. "Party mode"
5. Set the required room temperature for "Party mode".

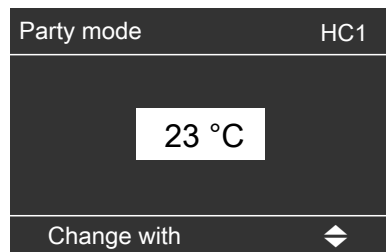

Fig. 18

Display in the standard menu

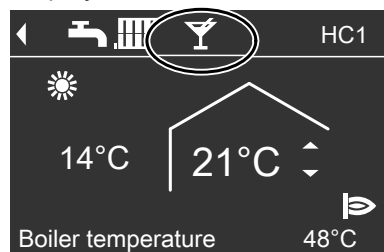

Fig. 19

Note

The display of the set room temperature does not change.

- The rooms are heated to the required temperature.
- Provided your heating contractor has not altered the settings, DHW is heated to the selected set temperature **first**, before central heating begins.
- The DHW circulation pump is switched ON (if installed).

Cancelling "Party mode"

- Automatically after 8 hours.

Note

If you want to make changes to this, contact your local heating contractor.

Or

- Automatically when the system switches to standard heating mode in accordance with the time program.



Or

- Set "Party mode" to "OFF".

Energy saving function "Economy mode"

Setting "Economy mode" for central heating

Extended menu

1. 
2. "Heating"
3. Poss.   for the required heating circuit.
4. "Economy mode"

Display in the standard menu

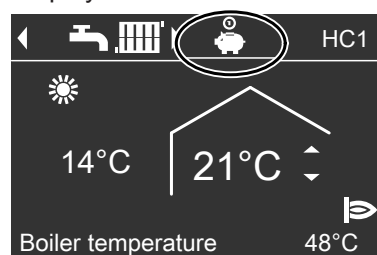

Fig. 20

Energy saving function "Economy mode" (cont.)

Note

The display of the set room temperature does not change.

Cancelling "Economy mode"

- Automatically when the system switches to reduced heating mode in accordance with the time program.
Or
- Set "Economy mode" to "OFF".

Energy saving function "Holiday program"

Setting the "Holiday program" for central heating

Note

The holiday program affects **all** heating circuits.
If you want to make changes to this, contact your local heating contractor.

The holiday program starts at 00:00 h on the day following your departure and ends at 00:00 h on the day of your return. This means the selected time program is active on the days of departure and return (see page 22).

Extended menu:

1. 
2. "Heating"
3. "Holiday program"
4. Set the required departure and return dates.

Holiday program		HC1
Leaving date:		
Date	We 13/06/2012	
Return date:		
Date	Fr 15/06/2012	
Select with		

Fig. 21

The holiday program has the following effect:

- **Central heating:**
 - For heating circuits in the operating program "Heating and DHW":
The rooms are heated to the selected reduced room temperature (see page 21).
 - For heating circuits in the operating program "Only DHW":
No central heating. Frost protection for the boiler and the DHW cylinder is active.
- **DHW heating:**
No DHW heating. Frost protection for the DHW cylinder is active.

Display in the standard menu

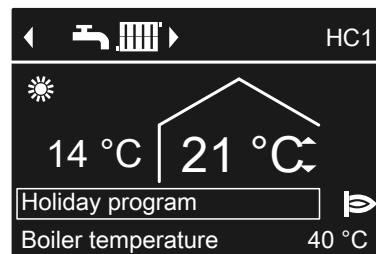



Fig. 22

Display in the extended menu

In the extended menu, you can call up the set holiday program under "Information" (see page 31).

Energy saving function "Holiday program" (cont.)**Cancelling or deleting the "Holiday program"**

Extended menu

1. 
2. "Heating"
3. "Holiday program"
4. "Delete program"

DHW heating

DHW temperature

Factory setting: 50 °C

Extended menu

1. 
2. "DHW"

3. "Set DHW temperature"
4. Set the required value.

Operating program





Further information can be found in chapter "Terminology" in the appendix.

Setting the operating program for DHW heating

For the preferred heating circuit

Standard menu

1.  for the operating program:
"Heating and DHW"
Or
"Only DHW"
2. OK to confirm.

3. Poss.  for the required heating circuit.
4. "Heating program"
5. "Heating and DHW"
Or
"Only DHW"

For information on the operating programs, see page 15.

For all heating circuits

Extended menu

1. 
2. "Heating"

Time program



Further information can be found in chapter "Terminology" in the appendix.

Setting the time program for DHW heating

Factory setting: **One** time phase from 05:30 to 22:00 h for every day of the week.

Extended menu:

1. 
2. "DHW"
3. "DHW time prog"
4. Set the required time phases.
Procedure for setting a time program, see page 15.

Note

- Between the time phases, DHW is not heated; only frost protection for the DHW cylinder is active.
- When setting time programs, please bear in mind that your heating system requires some time to heat the DHW cylinder to the required temperature.

DHW heating once, no longer in the time program

Note

The operating program "Heating and DHW" or "Only DHW" must be set for at least one system heating circuit.

Extended menu

1. 
2. "Heating"
3. "Party mode"
4. Disable "Party mode" again with "OFF" to prevent unintentional central heating with standard room temperature.

Time program (cont.)

Setting the time program for the DHW circulation pump

The time program for the DHW circulation pump is pre-set to **Automatic mode** at the factory. In other words, the DHW circulation pump operates in parallel to the DHW heating time program.

Extended menu:

1. 
2. "DHW"

3. "DHW circ time prog"

4. Set the required time phases.

Procedure for setting a time program, see page 15.

Note



Between time phases the DHW circulation pump remains off.

Switching off DHW heating

You do not want to heat DHW or provide central heating



For the preferred heating circuit

Standard menu

1.   for the operating program "**Standby mode**" (frost protection is active).
2. **OK** to confirm.

For all heating circuits





Extended menu

1. 
2. "Heating"
3. Poss.   for the required heating circuit.
4. "Heating program"
5. "Standby mode" (frost protection active)

You do not want to heat DHW, but do want to provide central heating

—

Extended menu

1. 
2. "Heating"
3. Poss.   for the required heating circuit.
4. "Heating program"
5. "Heating and DHW"
6.  until the menu is displayed.
7. "DHW"
8. "Set DHW temperature"
9. Set 10 °C.

Further adjustments

Setting the display contrast

Extended menu

1. 
2. "Settings"

3. "Contrast"

4. Set the required contrast.

Setting the display brightness

If you would like the texts in the menu to be more clearly legible, change the brightness for "Control". You can also alter the screen saver brightness.

3. "Brightness"

4. "Control" or "Screen saver"
5. Set the required brightness.

Extended menu

1. 
2. "Settings"





Entering names for the heating circuits

You can name all heating circuits individually. The abbreviations "HC1", "HC2" and "HC3" will be retained.

Example:

Name for "Heating circuit 2": Apartment

Extended menu

1. 
2. "Settings"
3. "Name for heating circ."
4. "Heating circuit 1", "Heating circuit 2" or "Heating circuit 3"
5. "Change?"
6. You can select the required symbol with /.
7. / takes you to the next character.
8. Press **OK** to accept all entered characters at once and simultaneously exit this menu.

Note

You can delete the name entered with "Reset?".

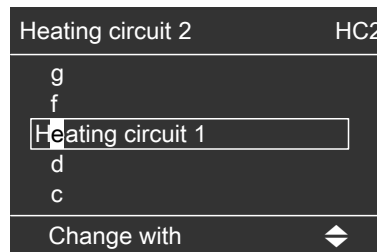

Fig. 23

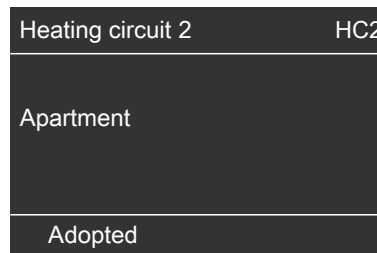

Fig. 24

The menu shows "Apartment" for "Heating circuit 2".



Fig. 25

Setting the preferred heating circuit for the standard menu

If your heating system has **several** heating circuits, you can select the heating circuit to be displayed in the standard menu.

Extended menu

1. 
2. **"Settings"**
3. **"Standard menu"**
4. Select the heating circuit:
 - **"Heating circuit 1"** (for heating circuit 1)
"HC1" is displayed
 - **"Heating circuit 2"** (for heating circuit 2)
"HC2" is displayed
 - **"Heating circuit 3"** (for heating circuit 3)
"HC3" is displayed

Setting the time and date

The time and date are factory-set. If your heating system has been shut down for a long time, it may be necessary to set the time and date.

3. **"Time/Date"**
4. Set the time and date.

Extended menu

1. 
2. **"Settings"**

Language selection

Extended menu

1. 
2. **"Settings"**

3. **"Language"**
4. Select the required language.

Setting the temperature unit (°C/°F)

Factory setting: °C

Extended menu

1. 
2. **"Settings"**

3. **"Temperature unit"**
4. Select the temperature unit **"°C"** or **"°F"**.

Restoring factory settings

You can reset the factory settings of all modified values for each heating circuit separately.

Extended menu

1. 
2. **"Settings"**

3. **"Standard setting"**
4. **"Heating circuit 1"**, **"Heating circuit 2"** or **"Heating circuit 3"**.

Restoring factory settings (cont.)

System setting	Settings and values that are reset
"Heating circuit 1", "Heating circuit 2" or "Heating circuit 3"	<ul style="list-style-type: none"> ▪ Set room temperature: 20 °C ▪ Set reduced room temperature ▪ Operating program ▪ Set DHW temperature ▪ Time program for central heating ▪ Time program for DHW heating ▪ Time program for DHW circulation pump ▪ Heating curve slope and level ▪ Comfort and energy saving functions ("Party mode", "Economy mode", "Holiday program") are deleted. <p>Note <i>If heating circuits have been named (see chapter "Naming heating circuits") the assigned name is retained.</i></p>

Scanning information

Subject to the components connected and settings made, you can call up current temperatures and operating conditions.

The extended menu splits the information into groups:

- "General"
- "Heating circuit 1"
- "Heating circuit 2"
- "Heating circuit 3"
- "DHW"
- "Solar"
- "Reset data"

Note

If heating circuits have been named (see chapter "Naming heating circuits") the assigned name is displayed.

Detailed options for calling up data on individual groups can be found in chapter "Options for calling up data".

Extended menu

1. ☰
2. "Information"
3. Select the group.
4. Select the required information.

Calling up the solar yield in conjunction with solar thermal systems

Extended menu

1. ☰
2. "Solar energy"

The solar energy yield is shown in diagrammatic form. The flashing line on the graph indicates that the current day is not yet over.

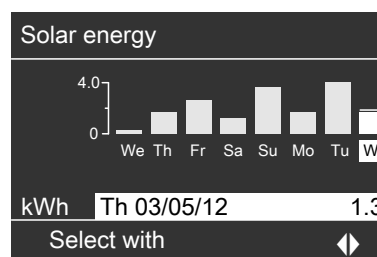

Fig. 26

Note

Further options for calling up data, e.g. for the solar circuit pump hours run, can be found in the extended menu under "Information" in the "Solar" group.

Resetting data

You can reset the following data:

- Burner hours run.
- Fuel consumption.
- In conjunction with a solar thermal system: Solar energy yield, solar circuit pump hours run and hours run output 22.
- All the above data simultaneously.

Extended menu

1. ☰
2. "Information"
3. "Reset data"

Scanning the service messages

If your heating system is due for a service, the symbol  flashes in the display, and "Service" appears.

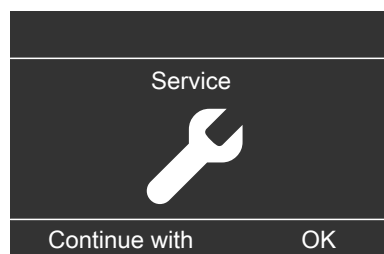

Fig. 27

Scanning the service messages (cont.)

1. You can call up the reason for the service with **OK**.

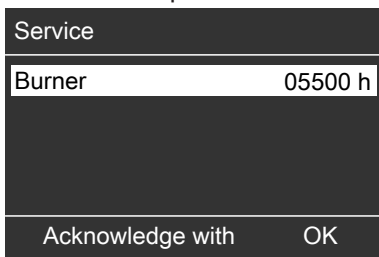

Fig. 28

2. Pressing **?** calls up information on the service that is due.
3. If you want to acknowledge the service message, follow the instructions in the menu. Contact your local heating contractor. The service message is transferred to the menu. Display in the standard menu

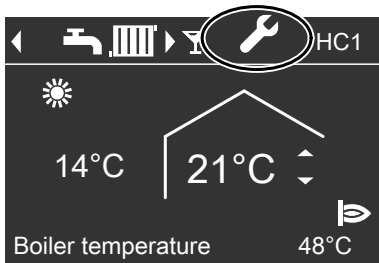

Fig. 29

Display in the extended menu

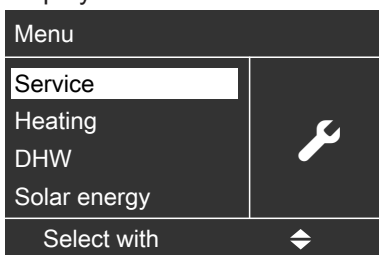

Fig. 30

Note

If the service can only be carried out at a later date, the service message is displayed again the following Monday.

Calling up an acknowledged service message

Extended menu

- 1.
2. **"Service"**

Scanning fault messages

If any faults have occurred in your heating system, the symbol flashes on the display and **"Fault"** is shown. The red fault indicator also flashes (see chapter "Starting the heating system").



Danger

If faults are not rectified, they can have life threatening consequences. Do not acknowledge fault messages several times in quick succession. If a fault occurs repeatedly, notify your heating contractor so the cause can be analysed and the fault rectified.

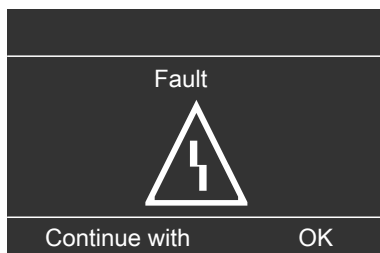

Fig. 31

Scanning fault messages (cont.)

1. You can call up the cause of the fault with **OK**.

Fault	
Outside t sens	18
Fault	A2
Acknowledge with OK	

Fig. 32

2. Pressing ? calls up information on the heating system performance.
Tips on which measures you can take yourself **before** notifying your heating contractor are also displayed.
3. Make a note of the cause of the fault and the fault code next to it on the right. In this example: **"Outside t sens 18"** and **"Fault A2"**.
This enables the heating contractor to be better prepared and may save you unnecessary travelling costs.
4. If you want to acknowledge the fault message, follow the instructions in the menu.
The fault message is transferred to the menu.
Display in the standard menu

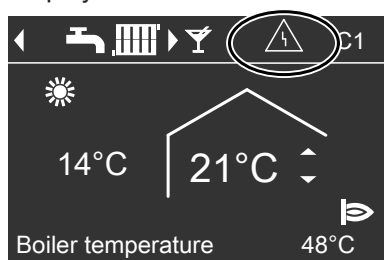

Fig. 33

Display in the extended menu

Menu	
Fault	
Heating	
DHW	
Solar energy	
Continue with OK	

Fig. 34

Note

- If you have connected up signalling equipment (e.g. a buzzer) for fault messages, this is deactivated when the fault message is acknowledged.
- If the fault can only be rectified later, the fault message will be displayed again the next day at 7:00 h, when the signalling equipment (if installed) is switched on again.

Calling up an acknowledged fault message

Extended menu

- 1.
2. "Fault"

Emissions test mode

Emissions test mode

Emissions test mode for testing flue gas with briefly raised boiler water temperature.
Emissions test mode should only be activated by your flue gas inspector during the annual inspection.

Extended menu

1. 
2. "Test mode"
3. "Flue gas test ON"



Test mode	
Boiler temperature	62°C 
Terminate with	OK

Fig. 35

The following functions are activated:

- The burner is switched on (the display shows symbol ).

Note

Burner start-up can be delayed, e.g. through fuel oil preheating.

- The pumps are started and the mixers remain in control function.
- The temperature controller regulates the boiler water temperature.



Note

The flue gas inspector can also enable emissions test mode if the controls are locked out by your heating contractor.

Ending emissions test mode

- Automatically after 30 min.
- Press **OK**.

Rooms are too cold

Cause	Remedy
The heating system is off.	<ul style="list-style-type: none"> ▪ Switch the ON/OFF switch ON (see diagrams from page 18). ▪ Switch ON the mains isolator (if installed, outside the boiler room). ▪ Reset the MCB in the power distribution board (main domestic MCB).
<ul style="list-style-type: none"> ▪ Control unit incorrectly adjusted. ▪ Remote control (if installed) set incorrectly.  Separate operating instructions	<p>Central heating must be enabled.</p> <p>Check settings and correct if required:</p> <ul style="list-style-type: none"> ▪ Operating program (see page 21) ▪ Room temperature (see page 21) ▪ Time (see page 29) ▪ Time program central heating (see page 21) ▪ Heating curve (see page 22)
The DHW cylinder is being heated.	Wait until the DHW cylinder has been heated up. Possibly reduce the DHW draw-off rate or temporarily reduce the standard DHW temperature.
No fuel.	<p>With oil/LPG: Check the fuel reserves and re-order if required.</p> <p>With natural gas: Open the gas shut-off valve. If necessary, check with your gas supply utility.</p>
"Fault" is displayed, and the red fault indicator flashes.	Call up and acknowledge the type of fault (see page 32). If necessary, notify your heating contractor.
"Screed drying" is active.	<p>No action required.</p> <p>After expiry of the screed drying time, the selected operating program will become active.</p>
Only with the Vitotronic 200, type KW6B: "Combustion controller" is shown on the display.	<p>Press R (see diagram on page 19). Acknowledge the fault (see page 32).</p> <p> Danger If faults are not rectified, they can have life threatening consequences. Do not acknowledge fault messages several times in quick succession. If a fault occurs repeatedly, notify your heating contractor so the cause can be analysed and the fault rectified.</p>
"Fault" is displayed and the red fault indicator on the burner is illuminated.	<p>Press the reset button on the burner. If there is no reset button, switch the ON/OFF switch (see diagrams from page 18) first OFF and then ON again.</p> <p> Danger If faults are not rectified, they can have life threatening consequences. Do not acknowledge fault messages several times in quick succession. If a fault occurs repeatedly, notify your heating contractor so the cause can be analysed and the fault rectified.</p>

What to do if...

Rooms are too cold (cont.)

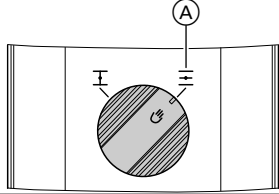
Cause	Remedy
Vitoair draught stabiliser faulty.	<p>Contact your local heating contractor. Press the rotary selector on the motor and turn it past position (A) as far as it will go.</p> 
Mixer motor faulty.	Adjust the mixer manually.

Rooms are too hot

Cause	Remedy
<ul style="list-style-type: none"> ▪ Control unit set incorrectly. ▪ Remote control (if installed) set incorrectly.  Separate operating instructions	<p>Check settings and correct if required:</p> <ul style="list-style-type: none"> ▪ Operating program (see page 21) ▪ Room temperature (see page 21) ▪ Time (see page 29) ▪ Time program central heating (see page 21) ▪ Heating curve (see page 22)
"Fault" is displayed, and the red fault indicator flashes.	Call up and acknowledge the type of fault (see page 32).
Mixer motor faulty.	Adjust the mixer manually.

There is no hot water

Cause	Remedy
The heating system is off.	<ul style="list-style-type: none"> ▪ Switch the ON/OFF switch ON (see diagrams from page 18). ▪ Switch ON the mains isolator (if installed, outside the boiler room). ▪ Reset the MCB in the power distribution board (main domestic MCB).
<ul style="list-style-type: none"> ▪ Control unit set incorrectly. ▪ Remote control (if installed) set incorrectly.  Separate operating instructions	<p>DHW heating must be enabled.</p> <p>Check settings and correct if required:</p> <ul style="list-style-type: none"> ▪ Operating program (see page 26) ▪ DHW temperature (see page 13) ▪ Time program DHW heating (see page 26) ▪ Time (see page 29)
No fuel.	<p>With oil/LPG: Check the fuel reserves and re-order if required.</p> <p>With natural gas: Open the gas shut-off valve. If necessary, check with your gas supply utility.</p>

There is no hot water (cont.)

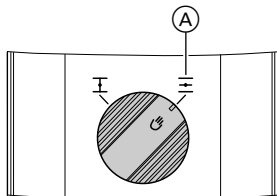
Cause	Remedy
Vitoair draught stabiliser faulty.	Contact your local heating contractor. Press the rotary selector on the motor and turn it past position A as far as it will go.
	
"Fault" is displayed, and the red fault indicator flashes.	Call up and acknowledge the type of fault (see page 32).

The DHW is too hot

Cause	Remedy
The control unit is incorrectly adjusted.	Check and correct the DHW temperature, if required (see page 26).
DHW heating is carried out by the solar thermal system.	Check and correct settings, if required, at the solar control unit.  Separate operating instructions

⚠ flashes and "Fault" is displayed

Cause	Remedy
Heating system fault.	Proceed as described on page 32.

🔧 flashes and "Service" is displayed

Cause	Remedy
The time for a service, as specified by your heating contractor, has arrived.	Proceed as described on page 31.

"Controls locked out" is displayed

Cause	Remedy
Control was blocked by your heating contractor.	Your heating contractor can lift this block.

"External hook-up" is displayed

Cause	Remedy
The operating program set at the control unit was changed by an external device, e.g. extension EA1.	No remedy is required.

What to do if...

"External program" is displayed

Cause	Remedy
The operating program set at the control unit was changed over by the Vitocom communication interface.	You can change the operating program.

Repair work

Cleaning

All equipment can be cleaned with a commercially available domestic cleaning agent (non-scouring). Clean the surface of the programming unit with the microfibre cloth provided.

Inspection and maintenance

Inspection and maintenance of your heating system is prescribed by the Energy Savings Order and DIN 4755, DVGW-TRGI 2008 and DIN 1988-8. Regular maintenance ensures trouble-free, energy efficient, environmentally responsible and safe heating. Your heating system must be serviced by an authorised contractor at least every 2 years. For this, we advise you to arrange an inspection and maintenance contract with your local heating contractor.

Boiler

Increasing boiler contamination raises the flue gas temperature and thereby increases energy losses. For that reason, all boilers should be cleaned annually.

DHW cylinder (if installed)

The DIN 1988-8 and EN 806 specify that maintenance and cleaning should be carried out no later than two years after commissioning and thereafter as required. Only a qualified heating contractor should clean the inside of a DHW cylinder and the DHW connections. Refill any water treatment equipment (e.g. a lock or injection system) in good time, if such equipment is installed in the cold water supply of the DHW cylinder. Observe the manufacturer's instructions.

Additionally for a Vitocell 100:

We recommend that the correct function of the sacrificial anode is checked annually by your heating contractor.

The anode function can be checked without interrupting the system operation. The heating contractor will check the earth current with an anode tester.

Safety valve (DHW cylinder)

The safety valve function should be checked every six months by venting, either by the system user or the local heating contractor (see the valve manufacturer's instructions). The valve seat may become contaminated.

Potable water filter (if installed)

To maintain high hygienic standards, proceed as follows:

- Replace filter element on non-back flushing filters every six months (visual inspection every two months).
- On back flushing filters, back flush every two months.

Damaged connecting cables

If connecting cables of the appliance or externally installed accessories are damaged, replace them with special connecting cables. Replace only with Viessmann cables. Notify your heating contractor accordingly.

Ordering fuel oil

Fuel oil quality

Vitoladens appliances are approved for the combustion of low sulphur fuel oil to DIN 51603-EL-1 (max. sulphur content 50 ppm).

A condensate neutralising system is not required (according to Code of Practice ATV-DVWK-A 251 [Germany]) when using this low sulphur fuel.

Fuel oil additives

Fuel oil additives are materials that can be used providing they offer the following characteristics:

- Improvement of stability during fuel storage.
- Increase in the thermal stability of the fuel.
- Reduction of odour development during filling.



Please note

Fuel oil additives can create residues and impair the safe operation of your heating system. The use of fuel oil additives that leave residues is not permissible.

Combustion improvers

Combustion improvers are additives for optimising fuel oil combustion.

Viessmann oil burners do not require combustion improvers, as these burners operate with clean and efficient combustion.



Please note

Combustion improvers can create residues and impair the safe operation of your heating system. The use of combustion improvers that leave residues is not permissible.

Biofuels

Biofuels are made from vegetable oil, e.g. sunflower or rape seed oil.



Please note

Biofuels can lead to damage on Viessmann oil burners.

With boilers built in or after 2012, up to 10 % added bio-components (FAME) are generally allowed. Fuel oil must comply with DIN 51603-6-EL A Bio 10.

If in doubt refer to your local heating contractor.

Overview of extended menu

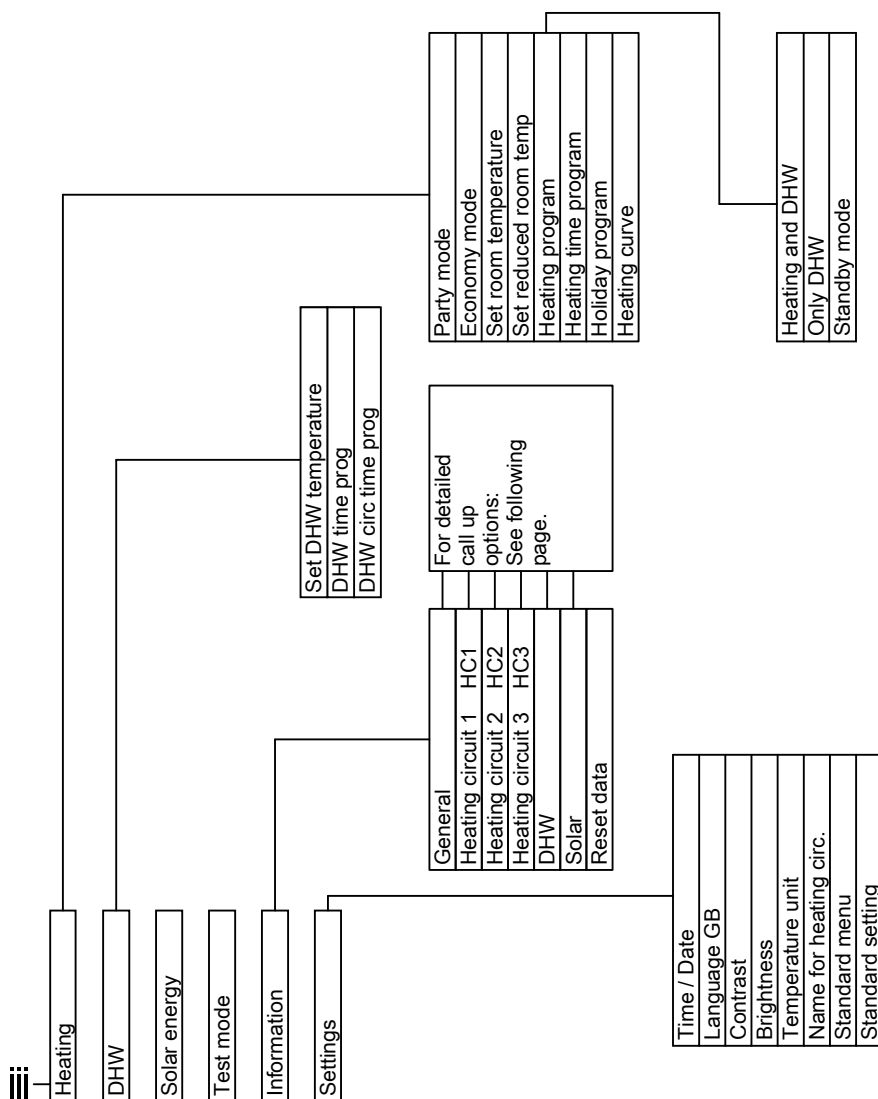

Fig. 36

Calling up options under "Information"

Note

Subject to the actual heating system equipment level, not all of the scans listed here may be available. You can scan more details where information is marked with ►.

Calling up options under "Information" (cont.)

General

"Outside temp"
"Boiler temperature"
"Flue gas temp"
"Sensor 9"
"Burner"
"Hours run"
"Burner stage 1"
"Hours run"
"Burner stage 2"
"Hours run"
"Fuel consumpt."
"Feed pump"
"Block 3rd pty dev"
"Central fault mess."
"Subscriber no."
"Input ext. EA1" ▶
"Time"
"Date"
"Radio clock signal"

Heating circuit 1 (HC1)

"Heating program" ▶
▪ "External hook-up"
▪ "Holiday program"
▪ "External program"
▪ "Party mode"
▪ "Economy mode"
▪ "Heating and DHW"
▪ "Only DHW"
▪ "Standby mode"
"Operating status" ▶
▪ "Standard heating mode"
▪ "Reduced mode"
▪ "Standby mode"
"Time program" ▶
"Set room temp"
"Room temperature"
"Set red. room temp"
"Set ext. room temp"
"Set party temp"
"Slope"
"Level"
"Heating circ pump"
"Holiday program" ▶

Heating circuit 2, 3 (HC2, HC3)

"Heating program" ▶
▪ "Screed drying"
▪ "External hook-up"
▪ "Holiday program"
▪ "External program"
▪ "Party mode"
▪ "Economy mode"
▪ "Heating and DHW"
▪ "Only DHW"
▪ "Standby mode"
"Operating status" ▶
▪ "Standard heating mode"
▪ "Reduced mode"
▪ "Standby mode"
"Time program" ▶
"Set room temp"
"Room temperature"
"Set red. room temp"
"Set ext. room temp"
"Set party temp"
"Slope"
"Level"
"Heating circ pump"
"Mixer"
"Flow temperature"
"Holiday program" ▶

DHW

"DHW time prog" ▶
"DHW circ time prog" ▶
"DHW temperature"
"Cylinder prim pump"
"DHW circ pump"

Calling up options under "Information" (cont.)

Solar

"Collector temp"
"Solar DHW"
"Solar circuit pump" (hours run)
"Solar energy history" ►
"Solar energy"
"Solar circuit pump" (ON/OFF) Or
"Solar circ pump speed"
"Heating suppr. DHW"
"SM1 output 22" (ON/OFF)
"SM1 output 22" (hours run)
"Sensor 7"
"Sensor 10"
"Heat suppr. heating"

Terminology

Operating program

The operating program determines whether you heat your rooms and DHW, or only heat DHW, or whether you switch off central heating (with frost protection monitoring).

Operating status

In the operating program **"Heating and DHW"**, the operating status changes from "Standard heating mode" to "Reduced heating mode" and vice versa. The times for the operating status changeover are defined by you when setting the time program.

Mixer extension kit

Assembly (accessory) for controlling a heating circuit with mixer.
See "Mixer".

Screed drying

Your heating contractor can, for example, enable this function for screed drying in your new build or extension. This means your screed is dried in line with a fixed time program (temperature/time profile) that is appropriate for the building materials used.

The screed drying function affects heating circuits with mixer:

- All rooms are heated according to the temperature/time profile.
Your settings for central heating have no effect for the duration of screed drying (max. 32 days).
- DHW heating is carried out (but priority control is cancelled).

Underfloor heating system

Underfloor heating systems are slow, low temperature heating systems and only respond very slowly to short term temperature changes.

Therefore, heating to the reduced room temperature at night and enabling **"Economy mode"** during short absences do not result in significant energy savings.

Heating mode

Standard heating mode

For periods when you will be at home during the day, use the standard room temperature to heat your rooms. Set the periods (time phases) using the time program for central heating.

Reduced heating mode

For periods when you will be absent or during the night, heat your rooms to the reduced room temperature. Set the periods using the time program for central heating. With underfloor heating systems, reduced heating mode only yields limited energy savings (see "Underfloor heating").

Terminology (cont.)**Room temperature-dependent heating mode**

With room temperature-dependent operation a room will be heated until the selected set room temperature has been reached. A separate temperature sensor must be installed in the room for this purpose. The heating output is regulated independent of the outside temperature.

Weather-compensated heating mode

In weather-compensated operation, the flow temperature is controlled according to the outside temperature. This means that only that amount of heat is generated that is necessary to heat the rooms to the room temperature you selected. The outside temperature is captured and transmitted to the control unit by a sensor fitted outside the building.

Heating curve

Heating curves illustrate the relationship between the outside temperature, room temperature (set value) and boiler water or (heating circuit) flow temperature. The lower the outside temperature, the higher the boiler water temperature or heating circuit flow temperature.

In order to guarantee sufficient heat and minimum fuel consumption at any outside temperature, the conditions of your building and your heating system must be taken into consideration. For this, you can adapt the heating curve yourself.

Note

If your heating system includes heating circuits with mixers, then the flow temperature for the heating circuit without mixer is higher by a selected differential than the flow temperature for the heating circuits with mixer.

The illustrated heating curves apply with the following settings:

- Heating curve level = 0
- Standard room temperature (set value) = 20 °C

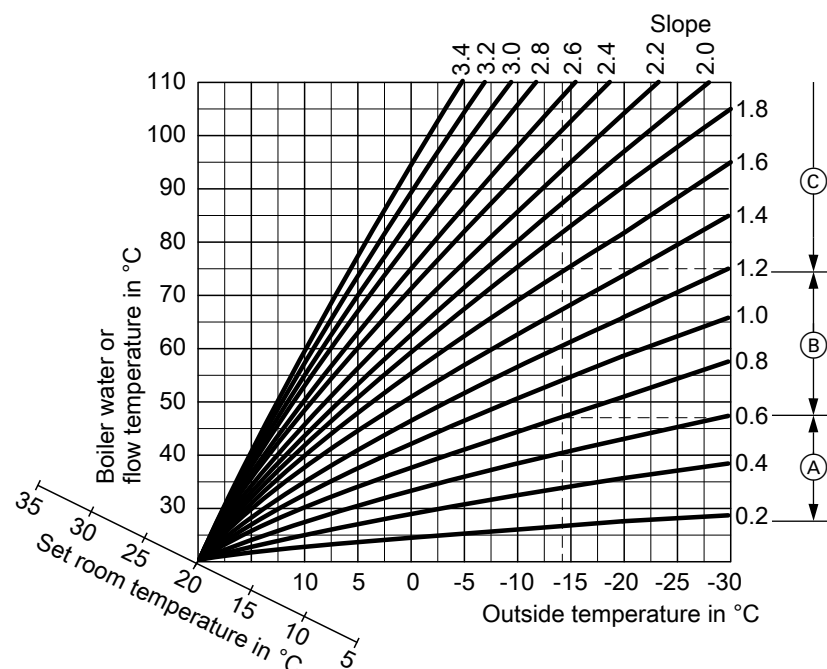

Fig. 37

For outside temperature **-14 °C**:

- (A) Underfloor heating system, slope 0.2 to 0.8
- (B) Low temperature heating system, slope 0.8 to 1.6
- (C) Heating system with a boiler water temperature in excess of 75 °C, slope 1.6 to 2.0

Terminology (cont.)

Factory settings: Slope = 1.4 and level = 0.

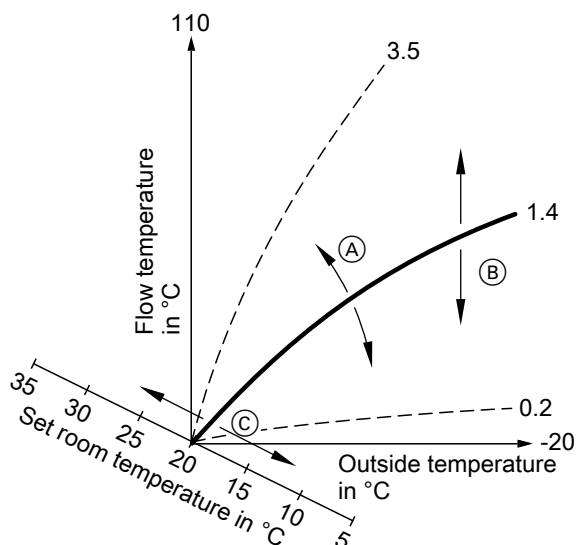

Fig. 38

- (A) Changing the slope:
The gradient of the heating curves changes.
- (B) Changing the level:
The heating curves are shifted in parallel in a vertical direction.
- (C) Changing the standard room temperature (set value):
The heating curves are offset along the "Set room temperature" axis.

Note

Setting the slope or level of the heating curve too high or too low will not result in damage to your heating system.

Both settings affect the level of the flow temperature, which may then be too low or unnecessarily high.

Tips on when and how to change the heating curve slope and level are displayed by pressing ?.

Heating circuit

A heating circuit is a sealed circuit between the boiler and radiators, in which the heating water circulates. A heating system may comprise several heating circuits. For example, one heating circuit for the rooms occupied by you and one heating circuit for the rooms of a separate apartment.

Heating circuit pump

Circulation pump for the circulation of the heating water in the heating circuit.

Mixer

A mixer mixes the water heated in the boiler with the cooled water returning from the heating circuit. The water, thus brought to the right temperature, is pumped to the heating circuit by the heating circuit pump. The control unit adjusts the heating circuit flow temperature via the mixer to suit different conditions, e.g. changing outside temperatures.

Room temperature

- Standard room temperature:
For periods when you will be at home during the day, set the standard room temperature.
- Reduced room temperature:
For periods when you will be absent or during the night, set the reduced room temperature. See also "Heating mode".

Safety valve

A safety device that must be installed in the cold water pipe by your heating contractor. The safety valve opens automatically to prevent excess pressure in the DHW cylinder.

Solar circuit pump

In conjunction with solar thermal systems. The solar circuit pump transports the heated heat transfer medium from the collectors into the indirect coil of the DHW cylinder.

Set temperature

Default temperature that should be reached; e.g. set DHW temperature.

Cylinder primary pump

Circulation pump for heating the DHW in the DHW cylinder.

Drinking water filter

A device that removes solids from the drinking water. The drinking water filter is installed in the cold water pipe upstream of the DHW cylinder or the instantaneous water heater.

Weather-compensated heating mode

See "Heating mode".

DHW circulation pump

The DHW circulation pump transports the DHW around a ring pipeline between the DHW cylinder and the draw-off points (e.g. hot tap). This ensures that hot water is rapidly available at the draw-off point.

Keyword index

- A**
Additives for fuel oil..... 40
- B**
Biofuels..... 40
- C**
Calling up
– Solar thermal system..... 31
Central heating
– Factory setting.....6
– Operating program..... 15, 21
– Switching off.....22
– Symbol..... 11
– Time phases.....22
– Time program.....22
Changing the heating characteristics..... 22
Cleaning information..... 39
Cold rooms.....35
Combustion improvers..... 40
Comfort (tips)..... 7
Comfort function, party mode.....23
Commissioning.....6, 19
Control levels..... 10
Controls..... 10
– Type KO1B..... 18
– Type KO2B..... 18
– Type KW6B..... 19
Controls locked out..... 37
Controls with the cover open..... 18
Cursor key..... 10
Cylinder primary pump..... 46
- D**
Date.....29
Daytime temperature (standard room temperature)..... 6, 12
Deleting a time phase..... 17
Delivered condition.....6
DHW circulation pump
– Energy saving..... 7
– Time phases.....27
– Time program.....27
DHW consumption..... 7
DHW heating..... 6
– Comfort..... 8
– Energy saving..... 7
– Factory setting.....6
– Operating program..... 15, 26
– Switching off.....27
– Time phases.....26
– Time program.....26
DHW heating outside of the time program..... 26
Display elements
– Type KO1B..... 18
– Type KO2B..... 18
– Type KW6B..... 19
Display illumination..... 28
Display screen saver..... 11
Drinking water filter..... 46
- E**
Economy mode
– Cancelling..... 24
– Central heating.....23
– Symbol..... 11
Emissions test mode..... 34
Energy saving (tips)..... 7
Energy saving function
– Economy mode, central heating.....23
– Holiday program.....24
Extended menu..... 12
External hook-up..... 15, 37
External program..... 15, 38
- F**
Factory setting.....6
Fault message..... 11
– Acknowledging.....32
– Calling up (acknowledged).....33
– Display..... 37
– Scanning..... 32
Frost protection monitoring..... 6, 19, 22
Fuel oil
– Additives.....40
– Ordering..... 40
– Quality..... 40
Further settings..... 29
- G**
Glossary..... 43
- H**
Heating circuit designation..... 28
Heating curve
– Comfort..... 8
– Setting.....22
– Slope/level.....22
Heating mode
– Reduced.....21
– Standard.....21
Heating system
– Shutting down..... 19
– Starting..... 19
Help menu..... 10
Help text..... 10
Holiday..... 7, 24
Holiday program
– Cancelling/deleting.....25
– Starting.....24
Hot water.....37
How to use the controls..... 12
- I**
Inspection.....39
- K**
Keys..... 10

L	
Language selection.....	29
Level, heating curve.....	22
M	
Maintenance.....	39
Maintenance contract.....	39
Menu	
– Extended menu.....	12
– Help.....	10
– Standard menu.....	11
Menu structure.....	41
Mixer.....	45
Mixer extension kit.....	43
N	
Names for the heating circuits.....	28
Night temperature (reduced room temperature).....	6
No hot water.....	36
Notice of completion.....	6
O	
ON/OFF switch.....	19, 20
Opening the control unit.....	9
Operating info.....	10
Operating program	
– Central heating, DHW.....	15
– Energy saving.....	7
– Frost protection.....	15
– Preferred heating circuit.....	12
– Setting, central heating.....	21
– Setting, DHW.....	26
– Special.....	15
Operating sequence.....	12
Ordering oil.....	40
P	
Party mode	
– Cancelling.....	23
– Setting.....	23
Power failure.....	7
Preferred heating circuit	
– Comfort.....	7
– Operating program.....	12
– Room temperature.....	12
– Standard menu.....	11
Preferred temperature.....	7
Presetting.....	6
Pressure gauge.....	19
Programming unit.....	10
R	
Reduced heating mode.....	6
Reduced room temperature.....	21
Repair work.....	39
Reset.....	29
Resetting data.....	31
Resetting fuel consumption.....	31
Resetting hours run.....	31
Restoring factory settings.....	29
Rooms	
– Too cold.....	35
– Too hot.....	36
Room temperature	
– Energy saving.....	7
– For reduced heating mode.....	21
– Preferred heating circuit.....	12
– Reduced.....	21
– Standard.....	21
S	
Safety valve.....	45
Scan	
– Fault message.....	32
– Information.....	31
– Operating conditions.....	31
– Service message.....	31
– Temperatures.....	31
Scanning information.....	31
Scanning operating conditions.....	31
Scanning the actual temperature.....	31
Screed drying.....	15
Screen saver.....	10, 11, 13
Service.....	11
Service message	
– Acknowledging.....	31
– Calling up (acknowledged).....	32
– Display.....	37
– Scanning.....	31
Setting	
– Operating program, central heating.....	21
– Room temperature.....	21
Setting the brightness.....	28
Setting the contrast.....	28
Setting the DHW temperature.....	26
Shutdown.....	20
Shutting down	
– Heating system with frost protection monitoring.....	19
– Heating system without frost protection monitoring.....	20
Slope, heating curve.....	22
Solar circuit pump.....	11, 46
Solar energy.....	31
Standard heating mode.....	6
Standard menu	
– Changing.....	29
– Operating program.....	12
– Operation.....	11
– Standard room temperature.....	12
Standard room temperature.....	21
Standard room temperature (day temperature).....	6
Standard settings.....	29
Standby mode.....	7, 19
– Operating program.....	15
– Switching off central heating.....	22
Starting	
– Frost protection monitoring.....	19
– Heating system.....	18
– Standby mode.....	19
Starting the appliance.....	19
Summertime changeover.....	6

Keyword index (cont.)

Switching off		Tips	
– Central heating.....	22	– Comfort.....	7
– DHW heating.....	27	– Energy saving.....	7
Symbols on the display.....	11	Troubleshooting.....	35
T		W	
Temperature		Water	
– DHW.....	26	– Too cold.....	36
– Scanning.....	31	– Too hot.....	37
– Setting.....	21	Window ventilation.....	7
– Standard room temperature.....	12	Wintertime/summertime changeover.....	6
Temperature unit.....	29	Wintertime changeover.....	6
Terminology.....	43		
Test mode.....	34		
Time.....	29		
Time/date, factory setting.....	7		
Time phases			
– Central heating.....	22		
– DHW circulation pump.....	27		
– DHW heating.....	26		
Time program			
– Central heating.....	22		
– Comfort.....	7, 8		
– DHW circulation pump.....	27		
– DHW heating.....	26		
– Energy saving.....	7		
– For DHW circulation pump.....	6		
– For DHW heating.....	6		
– Setting.....	15		





Your contact

Contact your local contractor if you have any questions regarding the maintenance and repair of your system. You may, for example, find local contractors on the internet under www.viessmann.com.

Viessmann Werke GmbH&Co KG
D-35107 Allendorf
Telephone: +49 6452 70-0
Fax: +49 6452 70-2780
www.viessmann.com

Viessmann Limited
Hortonwood 30, Telford
Shropshire, TF1 7YP, GB
Telephone: +44 1952 675000
Fax: +44 1952 675040
E-mail: info-uk@viessmann.com