

DE Montageanleitung Vitotrol 100-E	LT Montažo instrukcija Vitotrol 100-E
GB Installation instructions Vitotrol 100-E	LV Montāžas instrukcija Vitotrol 100-E
FR Notice de montage Vitotrol 100-E	NL Montagevoorschriften Vitotrol 100-E
BG Упътване за монтаж Vitotrol 100-E	NO Monteringsinstruksjon Vitotrol 100-E
CN 安装指南 Vitotrol 100-E	PL Instrukcja montażu Vitotrol 100-E
CZ Návod k montáži Vitotrol 100-E	PT Instruções de montagem Vitotrol 100-E
DK Montagevejledning Vitotrol 100-E	RO Instrucțiuni de montaj pentru Vitotrol 100-E
EE Paigaldusjuhend Vitotrol 100-E	RS Uputstvo za montažu Vitotrol 100-E
EL Οδηγίες συναρμολόγησης Vitotrol 100-E	RU Адаптер фланца Vitotrol 100-E
ES Instrucciones de montaje Vitotrol 100-E	SE Montageinstruktion Vitotrol 100-E
FI Asennusohje Vitotrol 100-E	SI Navodilo za montažo Vitotrol 100-E
HR Uputa za montažu Vitotrol 100-E	SK Montážny návod Vitotrol 100-E
HU Szerelési utasítás Vitotrol 100-E	TR Montaj Kılavuzu Vitotrol 100-E
IT Istruzioni di montaggio Vitotrol 100-E	UA Інструкція з монтажу Vitotrol 100-E



www.vitotrol.info

Viessmann Climate Solutions SE
35108 Allendorf
Telefon: +49 6452 70-0
Telefax: +49 6452 70-2780
www.viessmann.com

6179280 2/2022

VISSMANN

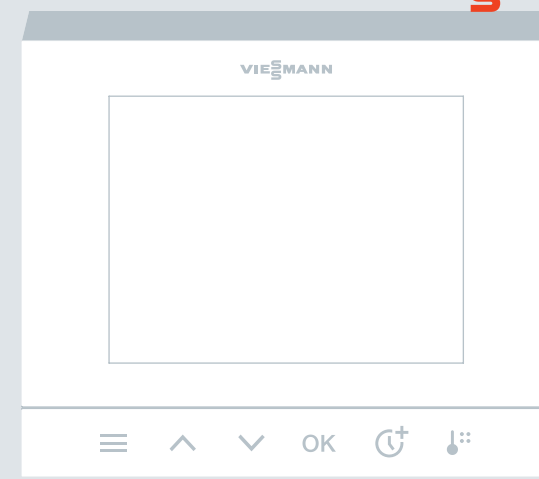

<https://viessmann.zendesk.com/hc/>

1

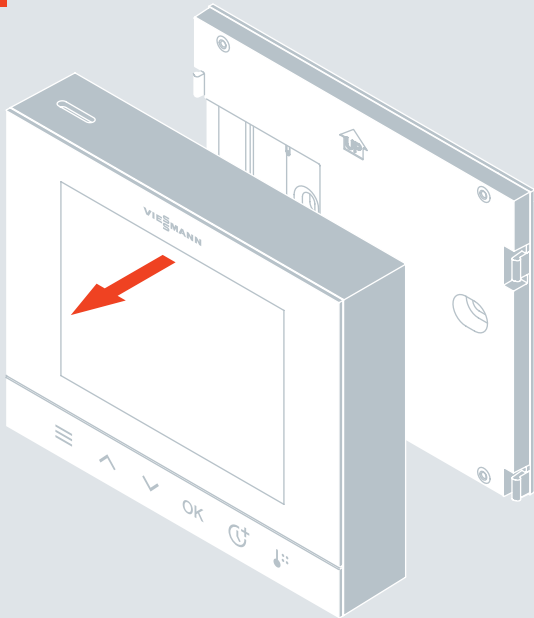

2

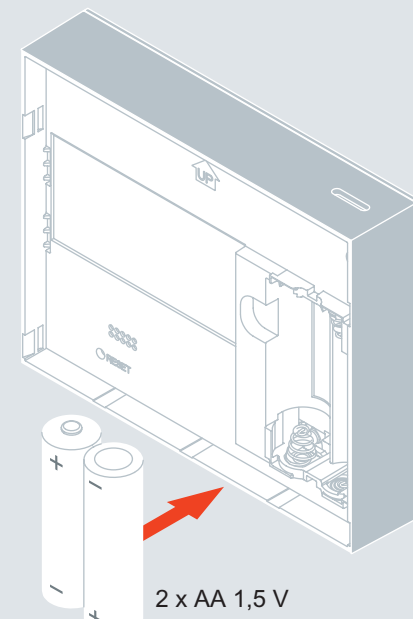

3

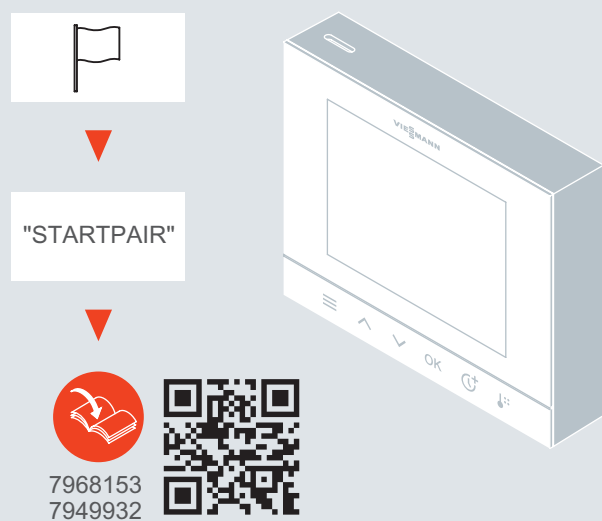

4



5

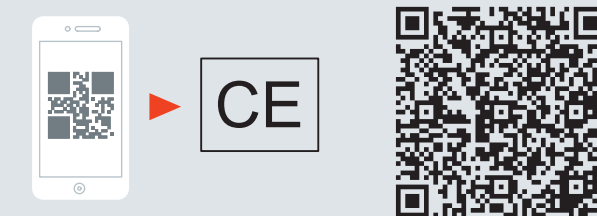
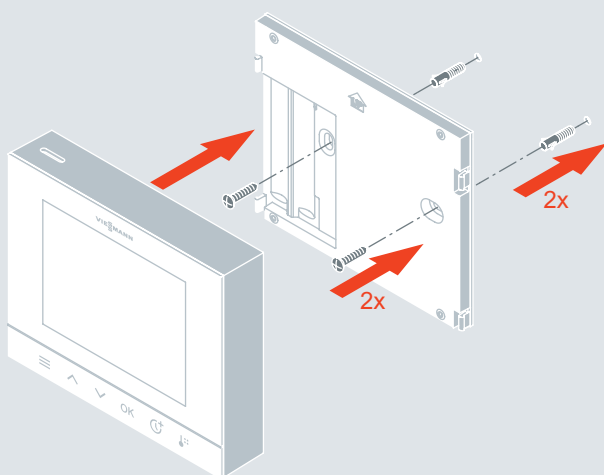
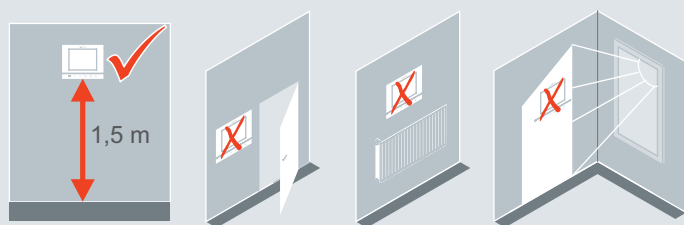

f: 2400,0 - 2483,5 MHz
P_{max}: 0,1 W (e.i.r.p.)

DE, AT, CH, LU: Sicherheitshinweise

Bitte befolgen Sie diese Sicherheitshinweise genau, um Gefahren und Schäden für Menschen und Sachwerte auszuschließen.

Zielgruppe
Diese Sicherheitshinweise richten sich an den Bediener der Heizungsanlage. Dieses Gerät kann auch von Kindern ab 8 Jahren und darüber sowie von Personen mit verringerten physischen, sensorischen oder mentalen Fähigkeiten oder Mangel an Erfahrung und Wissen benutzt werden, falls sie beaufsichtigt oder bezüglich des sicheren Gebrauchs des Geräts unterwiesen wurden und die daraus resultierenden Gefahren verstehen.

Bedingungen für den sicheren Betrieb
■ Beachten Sie die Bedienungsanleitungen Ihrer Heizungsanlage.
■ Das Gerät nur in Innenräumen montieren.
■ Das Gerät darf nicht mit Wasser in Berührung kommen.

- Gefahr**
Beschädigte Geräte gefährden Ihre Sicherheit.
■ Nehmen Sie ein beschädigtes Gerät nicht in Betrieb.
■ Instandsetzungsarbeiten am Gerät sind unzulässig.
■ Wenden Sie sich an Ihren Fachbetrieb.
- Gefahr**
Medizinische Hilfsmittel, z. B. Herzschrittmacher können gestört werden durch Funksignale. Bitte informieren Sie sich beim Hersteller des medizinischen Hilfsmittels.

Entsorgung
Gerät im Elektromüll (nicht im Hausmüll) entsorgen.

FR, BE, CH, CA : Consignes de sécurité

Veuillez suivre scrupuleusement les présentes consignes de sécurité afin d'exclure tout danger et dommage pour les personnes et les biens.

Destinataires
Les présentes consignes de sécurité s'adressent à l'utilisateur de l'installation de chauffage. Cet appareil n'est pas destiné à être utilisé par des personnes (y compris des enfants) présentant des capacités physiques, sensorielles ou mentales diminuées, voire manquant d'expérience et de connaissance. Si toutefois cela devait être le cas, ces personnes devront, pour leur sécurité, être surveillées ou informées du mode opératoire par une personne habilitée.

Conditions de fonctionnement fiable
■ Respectez les notices d'utilisation de votre installation de chauffage.
■ Ne montez l'appareil qu'à l'intérieur.
■ L'appareil ne doit pas entrer en contact avec de l'eau.

- Danger**
Des appareils endommagés présentent un risque pour votre sécurité.
■ Ne pas mettre un appareil endommagé en service.
■ Il est interdit de procéder à des travaux de réparation sur l'appareil.
■ Veuillez contacter votre installateur à ce sujet.
- Danger**
Des dispositifs médicaux (par exemple des stimulateurs cardiaques) peuvent être perturbés par les signaux radio. Veuillez vous renseigner à ce sujet auprès du fabricant du dispositif médical.

Elimination des déchets
Éliminer l'appareil avec les déchets d'équipements électroniques (pas avec les ordures ménagères).

GB, US, CA: Safety instructions

Please follow these safety instructions closely to prevent hazards, injury and material losses.

Target group
These safety instructions are intended for heating system users. This appliance can also be operated by children aged 8 and older, as well as by individuals with reduced physical, sensory or mental faculties or those lacking in experience and knowledge, provided such individuals are supervised or have been instructed in the safe use of this appliance and any risks arising from it.

Conditions for safe operation
■ Observe the operating instructions for your heating system.
■ The appliance must only be installed indoors.
■ The appliance must not come into contact with water.

- Danger**
Damaged equipment poses a safety hazard.
■ Never start up a damaged appliance.
■ Repair work on the appliance is not permitted.
■ Consult your contractor.
- Danger**
Wireless signals can interfere with medical devices, e.g. pacemakers. Please consult the manufacturer of the medical device.

Disposal
Dispose of the appliance as electrical waste (non-domestic waste).

BG: Указания за безопасност

Моля следвайте точно тези указания за безопасност, за да избегнете опасности и вреди за хората и имуществени щети.

Целева група
Тези указания за безопасност са предназначени за обслужващия отоплителната инсталация. Този уред може да се използва и от деца над 8-годишна възраст, както и от хора с намалени физически, сетивни или умствени възможности или без опит и познания, ако са под наблюдение или са инструктирани по отношение на безопасната употреба на уреда и разбират опасностите, произтичащи от работата с него.

Условия за безопасна експлоатация
■ Спазвайте ръководствата за обслужване на Вашата отоплителна инсталация.
■ Монтирайте уреда само в затворени помещения.
■ Уредът не трябва да влиза в контакт с вода.

- Опасност**
Повредени уреди застрашават безопасността Ви.
■ Не пускайте в експлоатация повреден уред.
■ Ремонтни работи по уреда не са разрешени.
■ Обърнете се към специализирана фирма.
- Опасност**
Възможно е радиосигнали да смущават функционирането на медицински помощни средства, напр. кардиостимулатори. Моля осведомете се от производителя на медицинското помощно средство.

Предавано от отпадък
Уредът трябва да се изхвърли като електрически отпадък (не заедно с битовите отпадъци).

US/CA: Information to the User

NOTICE: This device complies with Part 15 of the FCC Rules and with Industry Canada licence-exempt RSS standard(s). Operation is subject to the following two conditions:

- (1) this device may not cause harmful interference, and
- (2) this device must accept any interference received, including interference that may cause undesired operation.

Le présent appareil est conforme aux CNR d'Industrie Canada applicables aux appareils radio exempts de licence. L'exploitation est autorisée aux deux conditions suivantes:

- (1) l'appareil ne doit pas produire de brouillage, et
- (2) l'utilisateur de l'appareil doit accepter tout brouillage radioélectrique subi, même si le brouillage est susceptible d'en compromettre le fonctionnement.

NOTICE: Changes or modifications made to this equipment not expressly approved by Viessmann may void the FCC authorization to operate this equipment.

NOTE: This equipment has been tested and found to comply with the limits for a Class B digital device, pursuant to Part 15 of the FCC Rules. These limits are designed to provide reasonable protection against harmful interference in a residential installation. This equipment generates, uses and can radiate radio frequency energy and, if not installed and used in accordance with the instructions, may cause harmful interference to radio communications. However, there is no guarantee that interference will not occur in a particular installation. If this equipment does cause harmful interference to radio or television reception, which can be determined by turning the equipment off and on, the user is encouraged to try to correct the interference by one or more of the following measures:

- Reorient or relocate the receiving antenna.
- Increase the separation between the equipment and receiver.
- Connect the equipment into an outlet on a circuit different from that to which the receiver is connected.
- Consult the dealer or an experienced radio/TV technician for help.

Radiofrequency radiation exposure information:
This equipment complies with FCC radiation exposure limits set forth for an uncontrolled environment. This equipment should be installed and operated with minimum distance of 20 cm between the radiator and your body. This transmitter must not be co-located or operating in conjunction with any other antenna or transmitter.

Radio Transmitter Information:
This device includes a radio transmitter operating in the 2405-2480 MHz band to connect to the central unit.

中国：安全提示

请严格遵守本安全提示，以免造成人员危险和财产损失。

目标群体
本安全提示仅供系统操作人员使用。年龄在8岁及以上的儿童以及在身体、感官或精神方面受限或经验和知识不足的人员也可以使用该设备，但前提是必须在监督下进行，或者已接受过有关设备安全使用方面的指导并理解所产生的风险。

安全运行条件
■ 请遵守您的供暖系统的操作指南。
■ 设备仅允许安装在室内。
■ 设备不得与水直接接。

- 危险**
损坏的设备会危及您的安全。
■ 请不要将已损坏的设备投入运行。
■ 不允许在设备上运行维修工作。
■ 请联系您的专业公司。

危险
无线电信号可能会干扰例如心脏起搏器等医疗辅助设备。请咨询医疗辅助设备的制造商。

废弃物处理
设备必须作为电子垃圾处理（不得作为生活垃圾处理）。

