

Service instructions

for contractors

VIESMANN

Vitosol 300-TM Type SP3C

Vacuum tube collectors according to the heat pipe principle

For applicability, see the last page



VITOSOL 300-TM

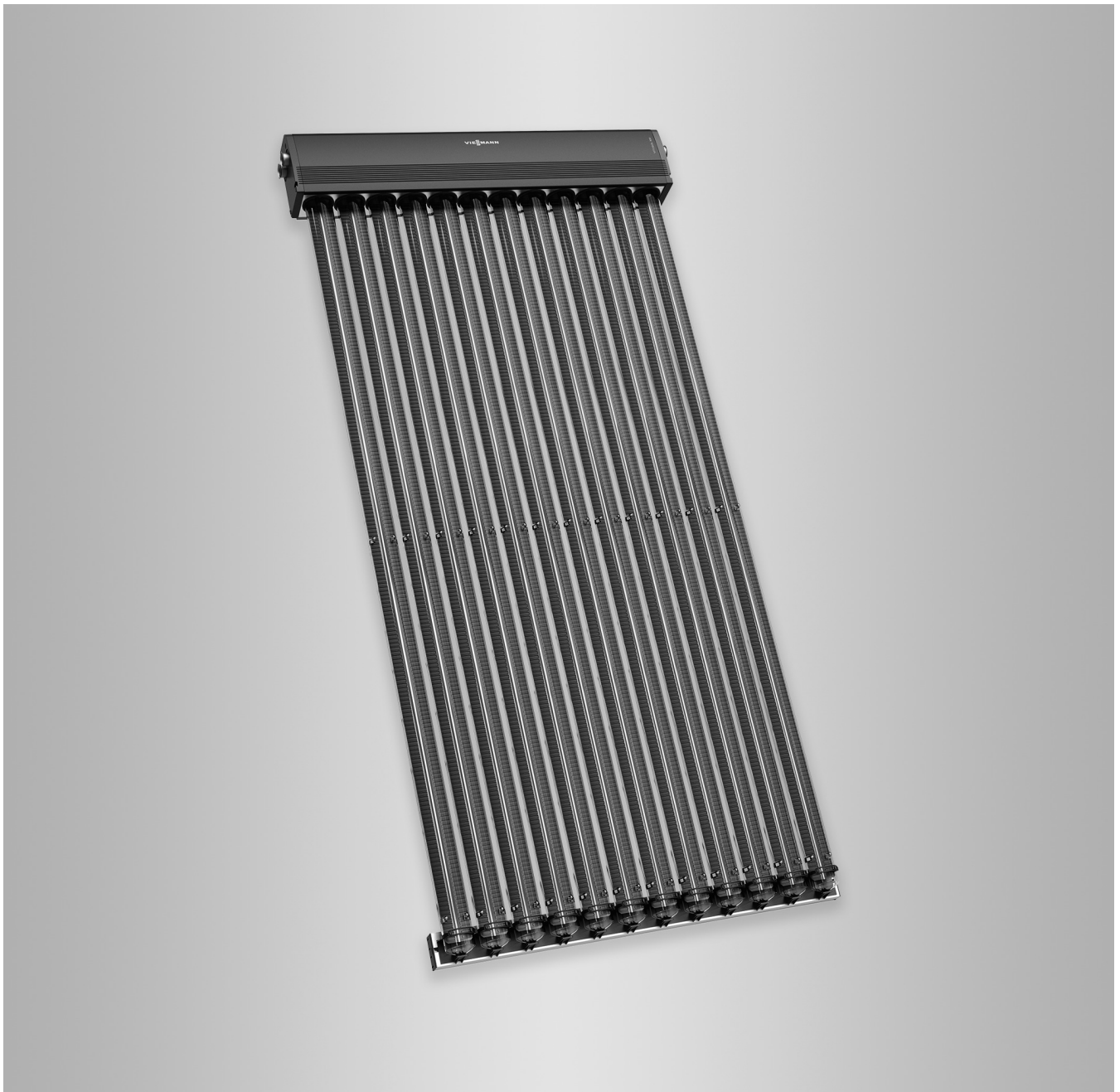

Safety instructions

Safety instructions



Please follow these safety instructions closely to prevent accidents and material losses.

Safety instructions explained



Please note

This symbol warns against the risk of material losses and environmental pollution.

Note

Details identified by the word "Note" contain additional information.

Target group

These instructions are exclusively intended for authorised contractors.

- Work on electrical equipment must only be carried out by a qualified electrician.
- The system must be commissioned by the system installer or a qualified person authorised by the installer.

Regulations to be observed

- National installation regulations
- Statutory regulations for the prevention of accidents
- Statutory regulations for the protection of the environment
- Codes of practice of the relevant trade associations
- All relevant safety regulations as defined by DIN, EN, DVGW, VDE and locally applicable standards
 - Ⓐ ÖNORM, EN and ÖVE
 - Ⓒ SEV, SUVA, SVTI and SWKI

Safety instructions for working on the system

Working on the system

- Isolate the system from the power supply, e.g. by removing the separate fuse or by means of a mains isolator, and check that it is no longer 'live'.
- Safeguard the system against reconnection.



Please note

Electronic assemblies can be damaged by electrostatic discharge. Prior to commencing work, touch earthed objects such as heating or water pipes, to discharge static loads.

Repair work



Please note

Repairing components that fulfil a safety function can compromise the safe operation of the system. Replace faulty components only with genuine Viessmann spare parts.









Safety instructions (cont.)**Auxiliary components, spare and wearing parts**

- !** **Please note**
Spare and wearing parts that have not been tested together with the system can compromise its function. Installing non-authorized components and making non-approved modifications or conversions can compromise safety and may invalidate our warranty.
For replacements, use only original spare parts supplied or approved by Viessmann.







Index

1. Information	Symbols	5
	Intended use	5
2. Commissioning, inspection, maintenance	Steps - commissioning, inspection and maintenance	6
3. Scope of inspection	14
4. Parts lists	Ordering parts	15
	Parts list	16
5. Specification	18
6. Certificates	Declaration of conformity	19

Symbols

Symbol	Meaning
	Reference to other document containing further information
	Step in a diagram: The numbers correspond to the order in which the steps are carried out.
	Warning of material losses and environmental pollution
	Live electrical area
	Pay particular attention.
	<ul style="list-style-type: none"> ▪ Component must audibly click into place. or ▪ Acoustic signal
	<ul style="list-style-type: none"> ▪ Fit new component. or ▪ In conjunction with a tool: Clean the surface.
	Dispose of component correctly.
	Dispose of component at a suitable collection point. Do not dispose of component in domestic waste.

The steps in connection with commissioning, inspection and maintenance are found in the "Commissioning, inspection and maintenance" section and identified as follows:

Symbol	Meaning
	Steps required during commissioning
	Not required during commissioning
	Steps required during inspection
	Not required during inspection
	Steps required during maintenance
	Not required during maintenance

Intended use

The collectors provide central heating backup and solar backup for DHW heating. They are only intended to be installed and operated in sealed systems that comply with EN 12976 and EN 12977, with due attention paid to the associated installation, service and operating instructions. Only operate the collectors with heat transfer medium approved by the manufacturer.

Intended use presupposes that a fixed installation in conjunction with permissible, system-specific components has been carried out.

Commercial or industrial usage for a purpose other than heating a building or DHW shall be deemed inappropriate.

Any usage beyond this must be approved by the manufacturer in each individual case.

Incorrect usage of the collectors or the installation system or incorrect operation is prohibited (e.g. the collectors being opened by the system user, failure to observe the installation instructions). Failure to observe these instructions can change functions, endanger life and limb of the user or third parties and will result in an exclusion of liability. Incorrect usage also applies if components in the system are modified from their intended use (e.g. through direct DHW heating in the collector).

Adhere to statutory regulations, especially concerning the hygiene of potable water.



Steps - commissioning, inspection and maintenance

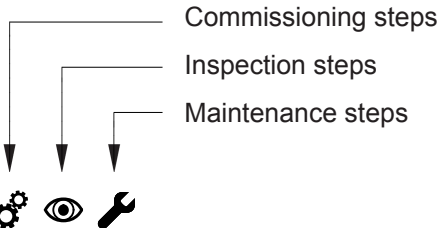

Page

				Page
•			1. Checking the pressure; adjusting the expansion vessel pre-charge pressure if necessary.....	7
•	•	•	2. Checking the function of the safety equipment.....	8
•	•	•	3. Checking the electrical connections.....	8
•			4. Filling, flushing and checking the solar thermal system for leaks.....	8
•	•	•	5. Determining the flow rate and adjusting it if necessary.....	10
•	•		6. Performing a test flush.....	11
•		•	7. Commissioning the system.....	12
•	•	•	8. Checking the switching function of the solar control unit.....	13
	•	•	9. Checking and replacing the heat transfer medium if required.....	13





Checking the pressure; adjusting the expansion vessel pre-charge pressure if necessary

This process **cannot** be carried out while the solar thermal system is in operation.

1. Cover the collectors with tarpaulins (accessories).
2. Determine the charge pressure:
 - Solar thermal system pressure = system pressure
 - System pressure + 0.1 bar pressure reserve for venting
3. Determine the pre-charge pressure of the expansion vessel:
 - Value for system pressure minus 0.3 bar for hydraulic seal
4. Check the pre-charge pressure and adjust if necessary.
 - The **solar service case** (accessories) contains a pressure gauge.
5. Enter the values in the table below (for subsequent inspection and maintenance work).

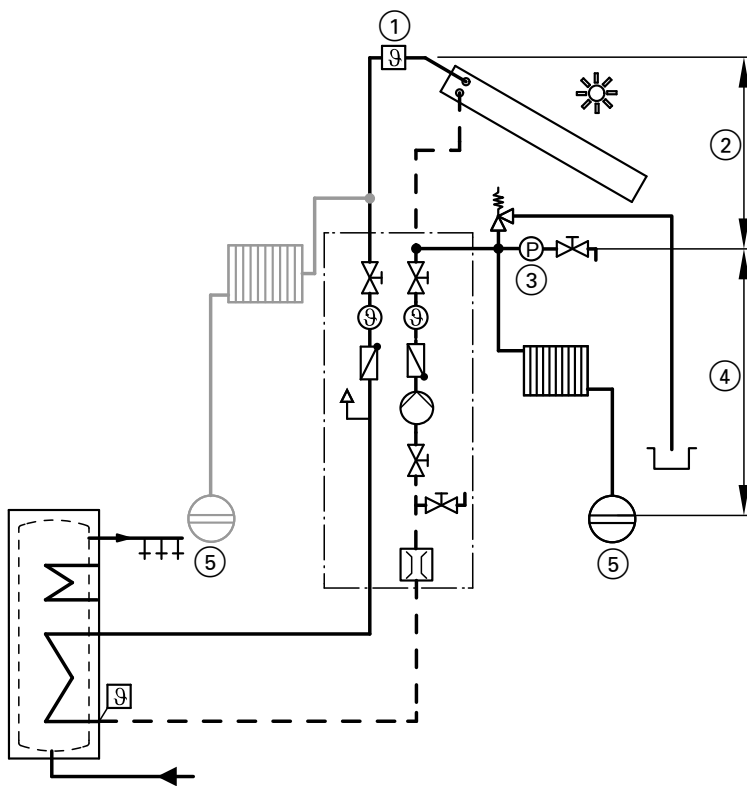

Fig. 1



Checking the pressure; adjusting the expansion... (cont.)

The following values result at 10 m static head (example)

①	Solar thermal system pressure	3.0 bar
②	Supplement, static head 0.1 bar/m	1.0 bar
③	System pressure (pressure gauge)	4.0 bar
	Pressure reserve for venting	+ 0.1 bar
	Charge pressure	4.1 bar
	System pressure (pressure gauge) after venting	4.0 bar
	Deduction for hydraulic seal	- 0.3 bar
④	Supplement per m of height difference between pressure gauge and expansion vessel	0.1 bar x 1 m = 0.1 bar
⑤	Pre-charge pressure, expansion vessel	3.8 bar
	Note Record this value on the expansion vessel with the note "Pre-charge pressure".	



Checking the function of the safety equipment

Check the safety valve:

- Response pressure
- Correct installation, with discharge pipe



Checking the electrical connections

Check the tightness of the electrical plug-in connectors and cable grommets; check cables for damage.



Filling, flushing and checking the solar thermal system for leaks

- !** **Please note**
Filling and commissioning the solar thermal system without first safeguarding the heat transfer results in thermal stress.
Cover the collectors and keep them covered until the heat transfer has been regulated.

- Accessories for flushing and filling the solar thermal system:
 - **Flushing and filling facility** (filling trolley and charging station)
These contain a high speed pump with a high pump rate, a filter and a container for heat transfer medium.
 - **Fill valve set**, consisting of shut-off valve, drain valve and fill valve.
- Flush the solar thermal system with heat transfer medium. Otherwise there is a risk that residual water from flushing may become mixed with the heat transfer medium. This would alter the properties of the heat transfer medium.
- Flush brazed copper pipes very thoroughly. Any residual scale may compromise the operation of the solar thermal system.



Filling, flushing and checking the solar... (cont.)

The following description is in conjunction with Solar-Divicon (see separate installation and service instructions)

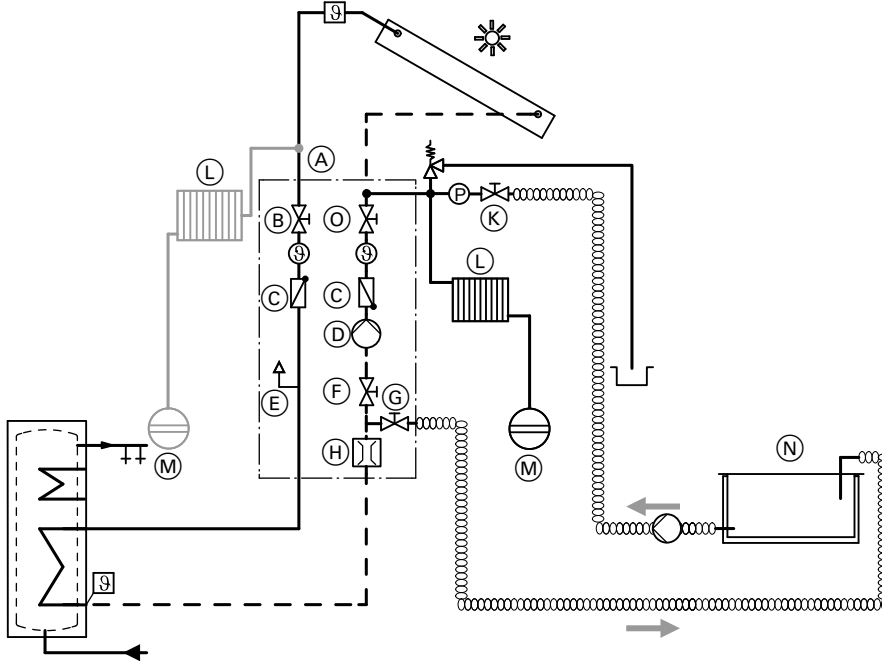

Fig. 2

- | | |
|---|-----------------------------------|
| (A) Solar-Divicon | (G) Drain valve |
| (B) Shut-off valve (flow) | (H) Flow indicator |
| (C) Non-return valves | (K) Fill valve |
| (D) Solar circuit pump | (L) Stagnation heat sink |
| (E) Air separator | (M) Expansion vessel |
| (F) Shut-off valve (adjusting screw above flow indicator (H)) | (N) Flushing and filling facility |
| | (O) Shut-off valve (return) |

1. Open shut-off valve (flow) (B): Turn the ball valve (thermometer) clockwise through 45°.
2. Close shut-off valve (return) (O): Turn the ball valve (thermometer) clockwise through 90°.
3. Close shut-off valve (F): Using a screwdriver, turn the slot on the adjusting screw to position "S".
4. Connect hoses of flushing and filling facility (N) to drain valve (G) and fill valve (K).
5. Fill the container of flushing and filling facility (N) with heat transfer medium.
6. Open drain valve (G) and fill valve (K).
7. Start the fill pump of flushing and filling facility (N).
8. Observe the fluid level in the container and top up with heat transfer medium if necessary to prevent any air entering the solar circuit. Leave the fill pump of flushing and filling facility (N) running until no more air bubbles rise to the top of the container (at least 20 to 30 min).

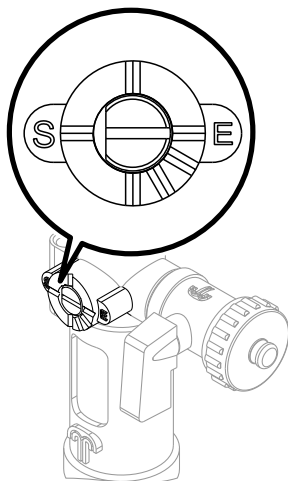

Fig. 3

Note
Briefly open shut-off valve (F) towards the end of the flushing process: Using a screwdriver, turn the slot on the adjusting screw above the flow indicator to the vertical position. Any air that remains in the return is eliminated.

4. Connect hoses of flushing and filling facility (N) to drain valve (G) and fill valve (K).





Filling, flushing and checking the solar... (cont.)

9. Close drain valve (G). Leave the fill pump of flushing and filling facility (N) running until the required charge pressure is reached.

Notes on residual ventilation

Even after thorough ventilation, some dissolved air will still remain in the heat transfer medium. This will be released as the temperature rises, and will be discharged via air separator (E).

10. Close fill valve (K); stop the fill pump of flushing and filling facility (N).
The pressure must not drop for at least 30 minutes.

11. Open shut-off valve (F): Using a screwdriver, turn the slot on the adjusting screw above the flow indicator to the vertical position.
12. Turn shut-off valves (B) and (C) to their operating positions (0°).
13. Set the circulation pump to manual mode. Open the air vent valve on air separator (E). Leave the circulation pump running **until the float in the flow indicator** holds a constant position while the pump is running.

Note

If there is air in the system, the float will oscillate.



Determining the flow rate and adjusting it if necessary

Check the flow rate at the top edge of the float. If no flow rate is indicated, the non-return valve in the return does not open automatically; the flow path is blocked.

Open shut-off valve (return) (C) (see diagram on page 9): Turn ball valve (thermometer) 45° clockwise. This opens a bypass around the non-return valve. If a flow rate is now indicated, the flow path is blocked. Perform a test flush to cause the non-return valve to open (see page 11).

In conjunction with multi stage circulation pumps, set the required flow rate via the output stage (see the following tables for approximate set values).

Note

With a Solar-Divicon, make the adjustment via shut-off valve (F) (adjusting screw above the flow rate indicator).

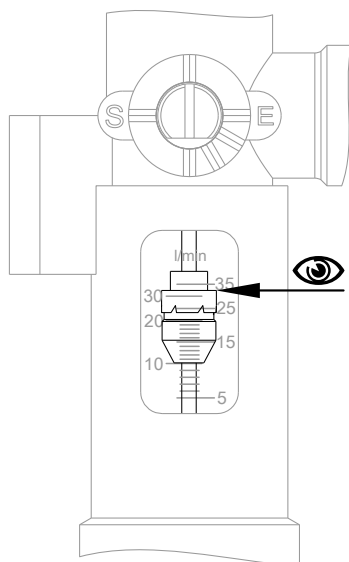

Fig. 4

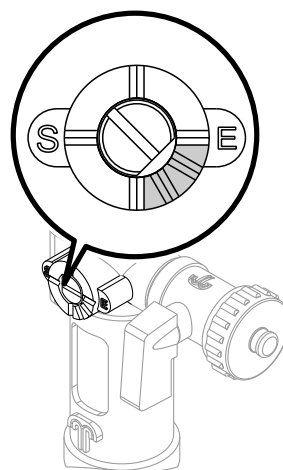

Fig. 5



Determining the flow rate and adjusting it if... (cont.)

Flow rates to be set

Specific flow rate 25 l/(h·m²)

Collector area in m ²	Flow rate in l/min
1.25	0.5
1.51	0.6
3.03	1.3
4.54	1.9
6.06	2.5
7.56	3.1
9.07	3.8
10.58	4.4
12.10	5.0
13.61	5.7



Performing a test flush

For components, see diagram on page 8

A final test flush should be carried out in two steps.

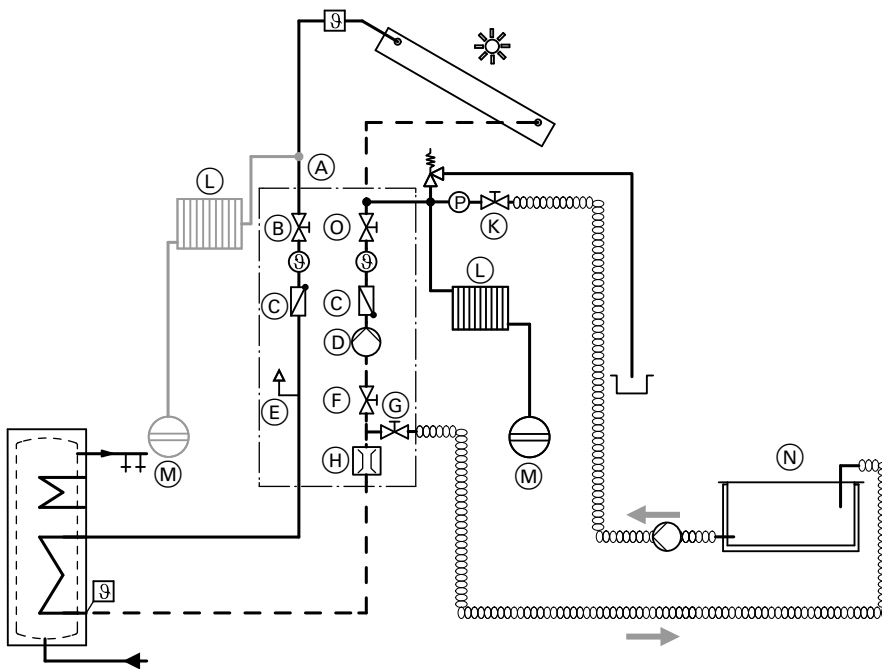

Fig. 6



Step 1

1. Close shut-off valve (F): Using a screwdriver, turn the slot on the adjusting screw to position "S".

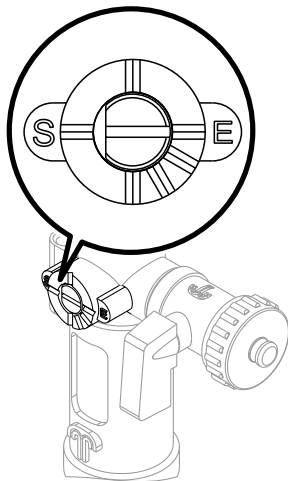

Fig. 7

2. Connect the pressure hose (return hose) of flushing and filling facility (N) to drain valve (G).
3. Connect the fill hose of flushing and filling facility (N) to fill valve (K).
4. Shut-off valve (flow) (B): Turn the ball valve (thermometer) to operating position 0° in vertical position.
5. Shut-off valve (return) (O): Turn the ball valve (thermometer) to the 45° position.
6. Open drain valve (G) and fill valve (K).
7. Start the fill pump of flushing and filling facility (N) and carry out the test flush. After the flushing process, close drain valve (G) and fill valve (K) again.

Step 2

1. Open shut-off valve (F): Using a screwdriver, turn the slot on the adjusting screw to position "E".

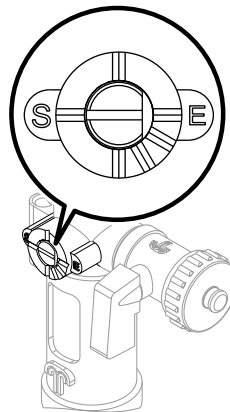

Fig. 8

2. Connect the pressure hose (return hose) of flushing and filling facility (N) to fill valve (K).
3. Connect the fill hose of flushing and filling facility (N) to drain valve (G).
4. Close shut-off valve (flow) (B): Turn the ball valve (thermometer) clockwise through 90°.
5. Open shut-off valve (return) (O): Turn the ball valve (thermometer) to the 0° vertical position.
6. Open drain valve (G) and fill valve (K).
7. Start the fill pump of flushing and filling facility (N). A pressure greater than 1 bar will open the non-return valve. After the flushing process, close drain valve (G) and fill valve (K) again. Turn shut-off valves (B) and (O) to their operating positions.

Note

Complete by checking the system pressure and readjusting it if required; see page 7



Close the air vent valve.

Note

With a Solar-Divicon, do this at air separator (E).



Observe operating instructions of installed components.



Checking the switching function of the solar control unit



Solar control unit installation and service instructions



Checking and replacing the heat transfer medium if required

- The heat transfer medium provided is a liquid based on 1,2-propylene glycol with a pH value of 9.0 to 10.5 and frost protection down to:
 - -28 °C, Tyfocor LS
 - -12 °C, Mediterráneo
 - -47 °C, Arctic
- Monitor the operating condition of the medium as part of the annual service of the solar thermal system by the heating contractor.
- The pH value and frost protection temperature can be checked with the **solar service case** (accessories).



Solar service case operating instructions

In some cases the manufacturer of the heat transfer medium can carry out a laboratory test of the medium, subject to arrangement.

- Manufacturer:
TYFOROP CHEMIE GmbH
Anton-Rée-Weg 7
D - 20537 Hamburg
Email: info@tyfo.de
Internet: www.tyfo.de
1. Check the pH value of the heat transfer medium using the pH strip in the solar service case. The colour of the pH strip indicates the approximate value. If the value is below 7.5, replace the heat transfer medium.

Information on replacing the heat transfer medium

The heat transfer medium can be mixed with Tyfocor G-LS.

Never mix with water or third party media.

2. Check the frost protection temperature of the heat transfer medium with an antifreeze tester or the manual refractometer in the solar service case.



Scope of inspection

Scope of inspection

The solar thermal system should be inspected once a year to ensure operational reliability.

In addition to this, a visual inspection of all essential components (e.g. collectors and pipework) is recommended every 3 to 5 years.

- Vent the solar thermal system.
- Compare system operating pressure with the set value. If the values are different, check the expansion vessel.
- Check the heat transfer medium.
- Start circulation pumps manually if necessary (listen for noises).
- Compare flow rate with set value.
- Check thermostatic mixing valve (if installed).
- Check plausibility of the solar parameters subject to the current insolation level (e.g. flow and return temperatures at the thermometers; collector and cylinder temperatures at the solar control unit).

Only check the safety valve if there are visible signs of it being open (e.g. deposits, drips).

Ordering parts

The following details are required when ordering parts:

- Serial no. (see type plate on the collector)
- Position number of the part

Parts list

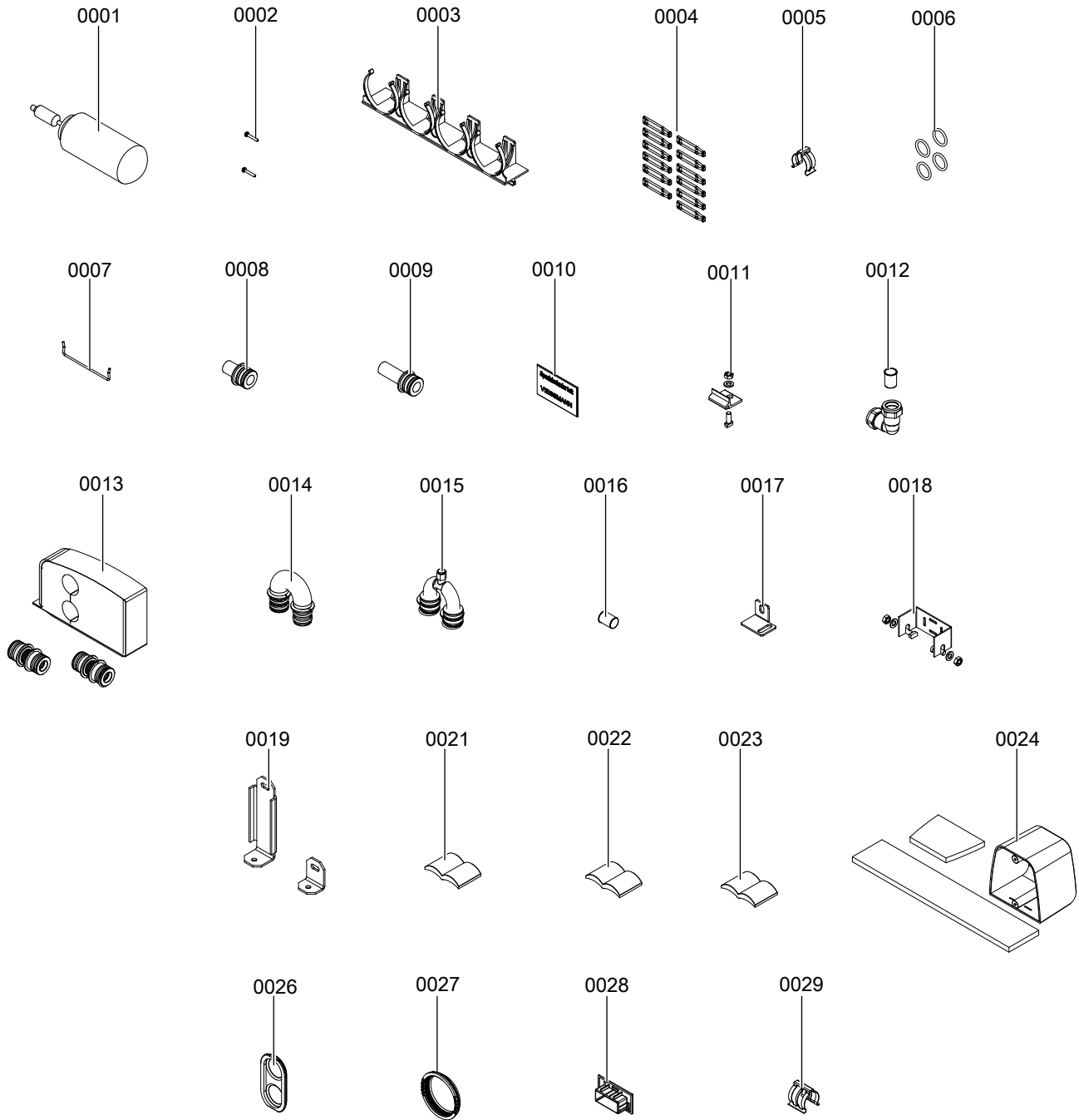

Fig. 9

Components

Parts list (cont.)

Pos.	Part
0001	Vacuum tube
0002	Screws for side cover
0003	Tube retainer
0004	Clamping rings (12 pce)
0005	Spring clip
0006	O-rings (4 pce)
0007	Collector fastening
0008	Connection pipe, short
0009	Connection pipe, long
0010	Special valve grease
0011	Clamping bracket
0012	Elbow fitting with support sleeve
0013	Connection pipe with thermal insulation
0014	Bend
0015	Bend with air vent valve
0016	Support sleeve
0017	Mounting bracket for sheet steel roofs
0018	Locking bracket
0019	Mounting bracket for horizontal installation
0021	Installation instructions
0022	Service instructions
0023	Operating instructions
0024	Thermal insulation cap
0026	Side seal
0027	Pipe gasket
0028	Cap
0029	Spring clip for connection pipes

Specification

Specification

Vitosol 300-TM, type SP3C, horizontal		1.25 m ²	1.51 m ²	3.03 m ²
Absorber area	m ²	1.26	1.51	3.03
Aperture area	m ²	1.33	1.60	3.19
Optical efficiency η_0 (relative to the aperture area)	%	75	75	75
Heat loss factor k_1	W/(m ² ·K)	1.8	1.8	1.5
Heat loss factor k_2	W/(m ² ·K ²)	0.007	0.007	0.007
Thermal capacity c	kJ/(m ² ·K)	8.4	8.4	8.4
Max. stagnation temperature	°C	150	150	150
Permiss. operating pressure	bar	6	6	6
Heat transfer medium content	Litre	0.75	0.87	1.55

Vitosol 300-TM, type SP3C, vertical		1.51 m ²	3.03 m ²
Absorber area	m ²	1.51	3.03
Aperture area	m ²	1.60	3.19
Optical efficiency η_0 (relative to the aperture area)	%	75.6	76
Heat loss factor k_1	W/(m ² ·K)	1.5	1.3
Heat loss factor k_2	W/(m ² ·K ²)	0.007	0.007
Thermal capacity c	kJ/(m ² ·K)	8.4	8.4
Max. stagnation temperature	°C	150	150
Permiss. operating pressure	bar	6	6
Heat transfer medium content	Litre	0.87	1.55

Declaration of conformity

Vitosol 300-TM, type SP3C

We, Viessmann Werke GmbH & Co. KG, D-35107 Allendorf, declare as sole responsible body that the named product complies with the provisions of the following directives and regulations:

2014/35/EU	Low Voltage Directive
2014/30/EU	EMC Directive
2014/68/EU	Pressure Equipment Directive

Applied standards

DIN EN 1991-1-1 2002 + AC 2009
 DIN EN 1991-1-4 2005
 DIN EN 1991-1-3 2004
 EN 12975 to Solar KEYMARK

In accordance with the following directives, this product is designated with **CE**:

Details according to the Pressure Equipment Directive (2014/68/EU):

- Heated pressure vessel
 - Class I according to appendix II, diagram 5
 - Module A according to appendix III
 - Identification of individual vessels with a content of less than 2 litres as an assembly according to article 3 (2)
- The pressure vessel was tested without fitted equipment (safety equipment).

The pressure vessel must be equipped in accordance with current national regulations prior to installation and commissioning.

For the energy assessment of heating and ventilation equipment to DIN V 4701-10 as required by the EnEV, when determining system values for the product **Vitosol**, the **product characteristics calculated as part of EC type testing according to the Efficiency Directive** can be used (see specification table).

Allendorf, 01 February 2017

Viessmann Werke GmbH & Co. KG



Authorised signatory Manfred Sommer

Applicability

Serial No.:

7749030

7749031

7749032

Viessmann Werke GmbH & Co. KG
D-35107 Allendorf
Telephone: +49 6452 70-0
Fax: +49 6452 70-2780
www.viessmann.com

Viessmann Limited
Hortonwood 30, Telford
Shropshire, TF1 7YP, GB
Telephone: +44 1952 675000
Fax: +44 1952 675040
E-mail: info-uk@viessmann.com

5790 791 GB Subject to technical modifications.