

Operating instructions for the system user

VIESMANN

Control unit with 7 inch touch display



VITODENS 200-W/222-W/222-F/242-F



For your safety

-  Please follow these safety instructions closely to prevent accidents and material losses.

Safety instructions explained

-  **Danger**
This symbol warns against the risk of injury.

-  **Please note**
This symbol warns against the risk of material losses and environmental pollution.

Note
Details identified by the word "Note" contain additional information.

Target group

These operating instructions are designed for heating system users. This appliance can also be operated by children aged 8 and older, as well as by individuals with reduced physical, sensory or mental faculties or those lacking in experience and knowledge, provided such individuals are supervised or have been instructed in the safe use of this appliance and any risks arising from it.

-  **Please note**
- Supervise children in the proximity of the appliance.
 - Never permit children to play with the appliance.
 - Cleaning and user maintenance must never be carried out by unsupervised children.

Safety instructions for working on the system

Connecting the appliance

- The appliance may be connected and commissioned only by authorised contractors.
- Only operate the appliance with suitable fuels.
- Observe the specified electrical connection requirements.
- Modifications to the existing installation may only be carried out by authorised specialists.

-  **Danger**
- Incorrectly executed work on the heating system can lead to life threatening accidents.
- Work on gas installations may only be carried out by a registered gas fitter.
 - Work on electrical equipment may only be carried out by a qualified electrician.

For your safety (cont.)**Working on the appliance**

- All settings and work on the appliance must be performed as specified in these operating instructions. Further work on the appliance may be carried out only by authorised contractors.
- Do not open the appliance.
- Do not remove casings.
- Do not modify or remove attachments or fitted accessories.
- Do not open or tighten pipe connections.

**Danger**

Hot surfaces can cause burns.

- Do not open the appliance.
- Never touch the hot surfaces of uninsulated pipes, fittings or flue pipes.

Auxiliary components, spare and wearing parts**Please note**

Components not tested with the heating system may damage the system or affect its function. Have all installation or replacement work carried out exclusively by your contractor.

Safety instructions for operating the system**Damage to the appliance****Danger**

Damaged equipment poses a safety hazard.

Check the appliance for external damage. Never start up a damaged appliance.

If you smell gas**Danger**

Escaping gas can lead to explosions which may result in serious injury.

- No smoking! Prevent naked flames and sparks. Never switch lights or electrical appliances on or off.
- Close the gas shut-off valve.
- Open windows and doors.
- Evacuate any people from the danger zone.
- Notify your gas and power supply utility and your local heating contractor from outside the building.
- Have the power supply to the building shut off from a safe place (outside the building).

If you smell flue gas

-  **Danger**
Flue gas can lead to life threatening poisoning.
- Shut down the heating system.
 - Ventilate the installation site.
 - Close all doors in the living space.

If there is a fire

-  **Danger**
Fire presents a risk of burns and explosion.
- Shut down the heating system.
 - Close the shut-off valves in the fuel supply lines.
 - Use a tested fire extinguisher, class ABC.

If water escapes from the appliance

-  **Danger**
If water escapes from the appliance there is a risk of electric shock.
- Shut down the heating system at the external isolator (e.g. fuse box, domestic distribution board).
 - Please notify your contractor.

If the heating system develops a fault

-  **Danger**
Fault messages indicate faults in the heating system. If faults are not rectified, they can have life threatening consequences.
Do not acknowledge fault messages several times in quick succession. Notify contractor so the cause can be analysed and the fault rectified.

Installation room requirements

-  **Danger**
Sealed vents result in a lack of combustion air. This leads to incomplete combustion and the formation of life threatening carbon monoxide. Never cover or close existing vents. Do not make any subsequent modifications to the building characteristics that could affect safe operation (e.g. cable/pipework routing, cladding or partitions).

-  **Danger**
Easily flammable liquids and materials (e.g. naphtha/petrol, solvents, cleaning agents, paints or paper) can cause deflagration and fire. Never store or use such materials in the boiler room or in direct proximity to the heating system.

- !** **Please note**
Incorrect ambient conditions can lead to heating system damage and can put safe operation at risk.
- Maintain the permissible ambient temperatures as detailed in these operating instructions.
 - Prevent air contamination by halogenated hydrocarbons (e.g. as contained in paints, solvents or cleaning fluids) and excessive dust (e.g. through grinding/polishing work).
 - Avoid continuously high humidity levels (e.g. through continuous drying of washing).



For your safety (cont.)**Extractors**

The operation of appliances that extract air to the outside (cooker hoods, extractors, air conditioning units, etc.) can create negative pressure. If the boiler is operated at the same time, this can lead to a reverse flow of flue gas.



**Danger**

The simultaneous operation of the boiler and appliances that extract air to the outside can result in life threatening poisoning due to a reverse flow of flue gas.

Take suitable steps to ensure an adequate supply of combustion air. If necessary, contact your contractor.

1. Liability	9
2. Introductory information	Symbols	10
	Terminology	10
	Intended use	11
	Product information	11
	Permissible ambient temperatures in the installation room	12
	Licence information	12
	Type plate	12
	Commissioning	12
	Your system is preset	12
	Energy saving tips	13
	Tips for greater comfort	14
3. Operation	Operating principles	15
	■ Status display with Lightguide	15
	Screen displays	15
	■ Standby display	15
	■ Default displays	16
	■ Home screen	16
	Buttons and symbols	16
	■ Buttons and symbols in menu bar (A)	17
	■ Buttons and symbols in function area (B)	17
	■ Buttons and symbols in navigation area (C)	17
	Overview of the "Main menu"	18
	■ Menus available in the "Main menu"	18
	Operating program	19
	■ Operating programs for central heating and DHW heating	19
	■ Special operating programs and functions	19
	Procedure for setting a time program	19
	■ Time programs and time phases	20
	■ Setting time phases	20
	■ Copying the time program to other days of the week	21
	■ Changing time phases	21
	■ Deleting time phases	22
4. Default displays	Default display "Heating circuit" or "Continuous operation"	23
	"DHW" default display	23
	"Energy cockpit" default display	23
	■ Calling up operating data for the solar thermal system	24
	■ Checking the temperatures in the DHW cylinder	25
	■ Calling up operating data for the heat generator	25
	■ Calling up the energy balance	26
	"Favourites" default display	26
	"System overview" default display	26
5. Central heating	Heating circuit selection	28
	Setting the room temperature for a heating circuit	28
	■ Setting temperature levels for central heating	28
	Switching central heating ON or OFF (operating program)	28
	Time program for central heating	29
	■ Setting a time program	29
	Setting the heating curve	29
	Temporarily adjusting the room temperature	30
	■ Switching on "Extended heating"	30
	■ Switching off "Extended heating"	31
	Adjusting the room temperature for longer periods at home	31
	■ Switching on "Holidays at home" 	32
	■ Switching off "Holidays at home" 	32

Index

	Saving energy during long periods of absence	32
	■ Switching on the "Holiday program" 	32
	■ Switching off the "Holiday program" 	32
6. DHW heating	DHW temperature	34
	Switching DHW heating on or off (operating program)	34
	Time program for DHW heating	34
	■ Setting a time program	34
	■ Setting a time program for the DHW comfort function	34
	■ Setting the time program for the DHW circulation pump	35
	One-off DHW heating outside the time program	35
	■ Switching on one-off DHW heating	35
	■ Switching off one-off DHW heating	35
	Increased DHW hygiene	35
	■ Switching on increased DHW hygiene	36
	■ Switching off increased DHW hygiene	36
	Switching DHW scald protection on/off	36
7. Further adjustments	Disabling operation	37
	■ Unlocking the controls	37
	■ Changing the password for the "Lock panel" function	37
	Setting the display brightness	37
	Switching the Lightguide on and off	38
	Entering names for heating circuits	38
	Setting the "Time" and "Date"	38
	Automatic "Summer/wintertime" changeover	38
	Setting the "Language"	39
	Setting "Units"	39
	Entering the contractor's contact details	39
	Setting the home screen	39
	Setting the gross calorific value and gas volume correction factor for consumption billing	40
	Switching on wireless connection to the remote control	40
	Switching internet access on or off	40
	■ Switching WiFi on or off	40
	■ Establishing a WiFi connection	41
	■ Static IP addressing	41
	Switching off the display screen for cleaning	41
	Restoring factory settings	42
8. Checks	Calling up help messages	43
	Checking information	43
	Checking licences for the integrated communication module	43
	■ Switching on access point	43
	■ Calling up the license information for third party components	43
	■ Third party software	44
	Checking service messages	44
	■ Calling up a service message	45
	Checking fault messages	45
	■ Calling up a fault message	45
	■ Resetting the burner after a burner fault	45
	Checking message lists	46
9. Emissions test mode	47
10. Start-up/shutdown	Switching the system off	48
	■ Shutting down heat generation with frost protection monitoring ("Standby mode")	48
	■ Shutting down heat generation without frost protection monitoring	48
	Switching on the system	49

11. What to do if...	Rooms are too cold	51
	Rooms are too hot	52
	There is no hot water	52
	The DHW is too hot	53
	"Fault" is displayed	53
	🔧 and "Service" are displayed	53
	"Panel locked" is displayed	53
	"External hook-up" is displayed	53
12. Maintenance	Cleaning	54
	Inspection and maintenance	54
	■ Appliance	54
	■ DHW cylinder	54
	■ Safety valve (DHW cylinder)	54
	■ Potable water filter (if installed)	54
	Damaged cables / lines	54
13. Appendix	Overview of "Main menu"	55
	Terminology	59
	■ Standby mode	59
	■ Setback mode (reduced heating mode)	59
	■ System version	59
	■ Operating program	59
	■ Operating status	59
	■ Operating mode	59
	■ Mixer extension kit	59
	■ Screed drying	59
	■ Underfloor heating	60
	■ Heating mode	60
	■ Heating curve	60
	■ Heating circuit	62
	■ Heating circuit pump	62
	■ Mixer	62
	■ Night setback	63
	■ Open flue operation	63
	■ Room sealed operation	63
	■ Room temperature	63
	■ Return temperature	63
	■ Safety valve	63
	■ Solar circuit pump	63
	■ Set temperature	63
	■ Summer mode	63
	■ Cylinder primary pump	64
	■ Set temperature	64
	■ Drinking water filter	64
	■ Flow temperature	64
	■ Weather-compensated operation	64
	■ Time program	64
	■ DHW circulation pump	64
	Information on disposal	64
	■ Disposal of packaging	64
	■ Final decommissioning and disposal of the heating system	65
14. Keyword index	66

Liability

No liability is accepted for loss of profit, unattained savings, or other direct or indirect consequential losses resulting from use of the WiFi interface integrated into the system or the corresponding internet services. No liability is accepted for losses resulting from inappropriate use.











Liability is limited to typical damage arising if a fundamental contractual obligation is violated through slight negligence, the fulfilment of which is essential for proper execution of the contract.

The limitation of liability shall not apply if the damage was caused deliberately or through gross negligence, or if mandatory liability applies due to product liability legislation.

The Viessmann General Terms and Conditions apply, which are included in each current Viessmann pricelist. The relevant data protection regulations and terms of use apply to the use of Viessmann apps. Viessmann accepts no liability for push notifications and email services, which are provided by network operators. The terms and conditions of the respective network operators therefore apply.

Introductory information

Symbols

Symbol	Meaning
	Reference to other document containing further information
	Step in a diagram: The numbers correspond to the order in which the steps are carried out.
	Warning of personal injury
	Warning of material losses and environmental pollution
	Live electrical area
	Pay particular attention.
	<ul style="list-style-type: none">▪ Component must audibly click into place.or▪ Acoustic signal
	<ul style="list-style-type: none">▪ Fit new component.or▪ In conjunction with a tool: Clean the surface.
	Dispose of component correctly.
	Dispose of component at a suitable collection point. Do not dispose of component in domestic waste.

Terminology

To provide you with a better understanding of the functions of your control unit, some terminology is explained. This information can be found in chapter "Terminology" in the Appendix.

Intended use

The appliance is intended solely for installation and operation in sealed unvented heating systems that comply with EN 12828, with due attention paid to CECS 215-2017 and the associated installation, service and operating instructions. It is only designed for heating up heating water that is of potable water quality.

Intended use presupposes that a fixed installation in conjunction with permissible, system-specific components has been carried out.

The appliance is intended exclusively for domestic or semi-domestic use; even users who have not had any instruction are able to operate the appliance safely.

Commercial or industrial usage for a purpose other than heating the building or DHW shall be deemed inappropriate.

Any usage beyond this must be approved by the manufacturer in each individual case.

Incorrect usage or operation of the appliance (e.g. the appliance being opened by the system user) is prohibited and will result in an exclusion of liability. Incorrect usage also occurs if the components in the heating system are modified from their intended use (e.g. if the flue gas and ventilation air paths are sealed).

Product information

The control unit is a boiler and heating circuit control unit for the following operating modes:

- Weather-compensated mode
- Continuous operation
- Room temperature-dependent mode

Your heating contractor will configure the operating mode during commissioning in accordance with your heating system. These instructions describe all 3 operating modes.

Weather-compensated mode

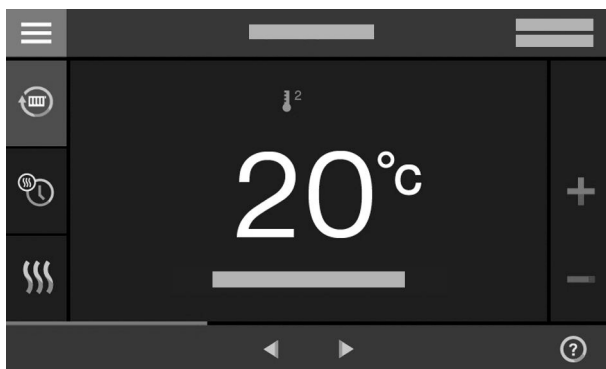

Fig. 1

In weather-compensated mode, the flow temperature level is controlled according to the outside temperature. The lower the outside temperature, the higher the flow temperature. This means that more heat is provided for central heating on cold days than on warmer days.

In weather-compensated mode, 1 heating circuit without mixer and up to 2 heating circuits with mixer can be operated with the control unit.

Continuous operation

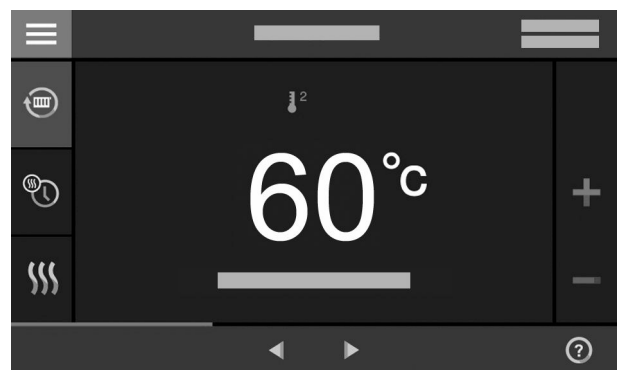

Fig. 2

In continuous operation, the heat generator provides heating water with a constant flow temperature regardless of the outside temperature.

In continuous operation, 1 heating circuit without mixer and up to 2 heating circuits with mixer can be operated with the control unit.

Room temperature-dependent mode

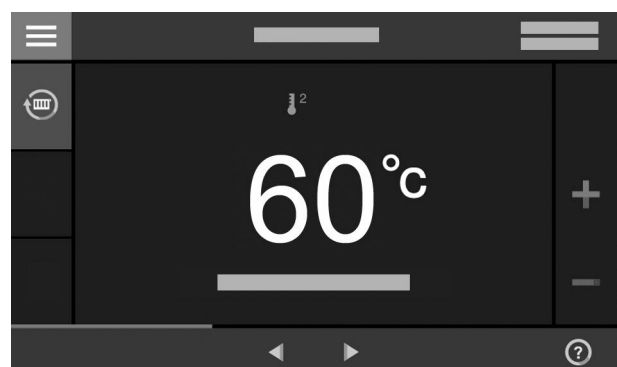

Fig. 3

Introductory information

Product information (cont.)

In room temperature-dependent mode, the central heating is switched on or off subject to the room temperature. The flow temperature remains constant. In room temperature-dependent mode, 1 heating circuit without mixer can be operated with the control unit.

Operation

The control unit is integrated into the heat generator and controls all functions of your system. The control unit is operated via a 7 inch touchscreen.

A communication module is integrated in the control unit. This means the system can also be operated remotely via the internet with an app.

In weather-compensated mode you can select some functions via a remote control; in room temperature-dependent mode this is possible via a room temperature controller.

Permissible ambient temperatures in the installation room

! **Please note**
The appliance may develop faults if it is operated outside the specified temperature ranges. Ensure that the specified temperature range is maintained in the installation room.

To avoid malfunctions, ensure a temperature between +5 and +40 °C.

Licence information

This product contains third party software, including open source software. You are authorised to use this third party software subject to compliance with the relevant licensing terms.

- Licences for the integral communication module: See page 43.
- Licences for the programming unit: See page 43.

Type plate

The type plate of the heat generator contains extensive product information and an appliance-specific **QR code with the marking "i"** for direct access to product-specific information and product registration on the internet.

The QR code contains the credentials for the registration and product information portal, and the 16-digit serial number.

Commissioning

The commissioning and matching of the appliance to local conditions and building characteristics, as well as instructing the user in the operation of the system, must be carried out by your contractor.

As the operator of new combustion equipment, you may be obliged to notify the local flue gas inspector of the installation without delay [check local regulations]. Your local flue gas inspector (where applicable) will also provide you with information on additional activities concerning your combustion equipment (such as regular testing, cleaning).

Your system is preset

Your heating system is preset at the factory and is therefore ready for operation following commissioning by your contractor:

Your system is preset (cont.)

Central heating in weather-compensated mode

- Between **06:00 h and 22:00 h**, rooms are heated to 20 °C "**Room set temperature**" (standard room temperature).
- Between **22:00 h and 06:00 h**, rooms are heated to 3 °C "**Set reduced room temperature**" (reduced room temperature, frost protection).

Central heating in continuous operation

- Between **06:00 h and 22:00 h**, the set flow temperature is 60 °C ("**Set normal flow temperature**")
- Between **22:00 h and 06:00 h** the set flow temperature is 20 °C ("**Reduced set flow temperature**", frost protection)

Central heating in room temperature-dependent mode

- The rooms are heated in accordance with the settings on your room temperature controller.

DHW heating

- Between **05:30 and 22:00 h**, the DHW is heated to 50 °C "**Set DHW temperature**". Any installed DHW circulation pump is switched on.
- Between **22:00 and 05:30**, the DHW cylinder is not reheated. Any installed DHW circulation pump is switched off.

Note

*Any DHW heating started before **22:00** remains on until the set DHW temperature has been reached.*

Frost protection

- Your heat generator and DHW cylinder (if installed) are protected against frost.

Wintertime/summertime changeover

- This changeover is automatic.

Date and time

- The date and time were set by your heating contractor.

You can change the settings at any time to suit your individual requirements.

Power failure

All settings are retained if there is a power failure.

Energy saving tips

Saving energy when using central heating

- Do not overheat your home. Every degree of room temperature reduction saves up to 6 % on your heating bills.

Weather-compensated mode and room temperature-dependent mode:

Do not set your standard room temperature ("**Room set temperature**") to above 20 °C: See page 28.

- Heat your home to the reduced temperature at night or during regular absences:
 - Weather-compensated mode:
Reduced room temperature
 - Continuous operation and room temperature-dependent mode:
Reduced flow temperature

For this, adjust the settings in the time program for central heating ("**Time program, heating**"): See page 29.

In room temperature-dependent mode, time programs for central heating can only be set at the room temperature controller.



Operating instructions for room temperature controller

- To switch off functions that are not required (e.g. central heating in summer), set the operating program to "**Standby mode**" for the relevant heating circuits: See page 28.
- Only for weather-compensated mode:
If you are going away, set the "**Holiday program**": See page 32.
During the period that you are away, the room temperature will be reduced and DHW heating switched off.

Saving energy on DHW heating

- At night or during regular absences, heat the DHW to a lower temperature. To do so, adjust the time program for DHW heating: See page 34.
- Switch on DHW circulation only for those times in which you regularly use hot water. For this, adjust the time program for the DHW circulation pump: See page 35.

For additional energy saving functions, please contact your contractor.

More comfort in your home

- Set your individual preferred temperature: See page 28.
- Adjust the time program for your heating circuits so that your individual preferred temperature is automatically reached when you are present: See page 29.
In room temperature-dependent mode, time programs for central heating can only be set at the room temperature controller.
- Only for weather-compensated mode:
Adjust the heating curves so that your home is heated with your individual preferred temperature all year round: See page 29.
- Only for weather-compensated mode and continuous operation:
If you need a higher room temperature in the short term, select the **"Extended heating"** function: See page 30.
Example: Late in the evening, the reduced room temperature is set by the time program. Your guests stay longer.
- Only for weather-compensated mode:
If you are spending more time than usual in your home, select the **"Holidays at home"**  function: See page 31
E.g. for public holidays or when the children are on school holidays.

Sufficient DHW heating for your needs

- Adjust the time program for DHW heating so that there is always sufficient hot water in accordance with your habitual routines: See page 34.
Example: You need more DHW in the morning than in the daytime.
- Adjust the time program for the DHW circulation pump so that DHW is available immediately from the taps during periods when hot water is drawn more frequently: See page 35.
- If you need your DHW temperature to be higher for a short while, select "One-off DHW heating outside the time program": See page 35.

Operating principles

All your system settings can be made via the programming unit, remote control units or other room temperature control devices and the ViCare app.

Touchscreen operation

The programming unit is equipped with a display. To input settings and check information, tap the on-screen buttons.

Operation via remote control units or room temperature control devices



Separate operating instructions

Operation via ViCare app

The ViCare app allows you to operate your system via a mobile device, e.g. smartphone.

Available functions depend on the system equipment e.g. with/without ViCare components for individual room control.

Check the following system requirements for operation via the app:

- Viessmann system that can be connected via Vito-connect or an integrated communications module.
- WiFi connection from router for control with internet access
- Smartphone or tablet with operating system:
 - iOS
 - Android

Further information on using the ViCare app: See www.vicare.info.

Status display with Lightguide

Dependent upon the heat generator, during operation at the lower or upper edge of the programming unit, a Lightguide is displayed.

Meaning of the display:

- Lightguide is illuminated constantly:
You are operating the control unit. Every input operation is confirmed by a brief flashing of the Lightguide.
- Lightguide flashes quickly:
There is a fault in the system.
- Lightguide pulsates slowly:
Display is in standby mode.

Note

You can turn off this function if you wish: See chapter "Switching the Lightguide on and off".

Note

You can switch off the Lightguide. See page 38.

Screen displays

Standby display

If the controls have not been operated for some time, the display initially switches to the **standby display**.



Fig. 4

After a few minutes, the illumination is switched off.

Screen displays (cont.)

Default displays

The default displays provide access to the most important settings and checks.

Use ◀▶ to choose between the following default displays:

- Heating circuit or Continuous operation
- DHW

- Energy cockpit
- Favourites
- System overview

For further information on the default displays: See page 23 onwards.

Home screen

After switching on or activating the control unit the home screen is shown.

In the delivered condition, the default display "**Heating circuit**" or "**Continuous operation**" is shown as home screen. The type of display depends on the operating mode (weather-compensated mode, continuous operation, room temperature-dependent mode). You can specify a different default display for the home screen: See page 39.

Note

You can prevent operation of the home screen: See page 37.

If you do so, you will not be able to make adjustments on either the home screen or the main menu.

"Panel locked" is displayed.

Call up the home screen as follows:

- Standby display active:
Tap anywhere on the screen.
- From the "**Main menu**":
Tap 🏠.

Buttons and symbols

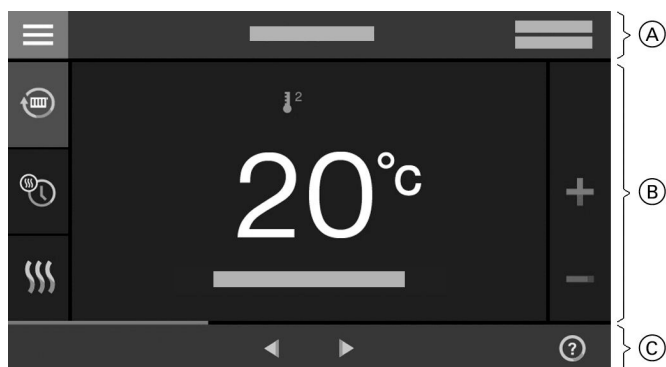

Fig. 5 Example: Weather-compensated mode

- (A) Menu bar
- (B) Function area
- (C) Navigation area

Note

Some functions are not available in room temperature-dependent mode. Where applicable, these functions can be set on the room temperature controller, e.g. 🕒 time program for room heating.

Buttons and symbols (cont.)

Buttons and symbols in menu bar (A)

Note

Not all buttons and symbols are available in room temperature-dependent mode, for example the heating circuit selection.









 Calls up the "Main menu".
 "Heating circuit ..."
 Selects the heating circuit.

Note
 This choice is only available if there are several heating circuits in your system.

System data:

- Date
- Time

Interfaces:

-  No data transfer
-  No WiFi connection
-  Establishing a connection
-  Communication error
-  WiFi connection is enabled (very low reception quality).
-  WiFi connection is enabled (low reception quality).
-  WiFi connection is enabled (medium reception quality).
-  WiFi connection is enabled (high reception quality).



Buttons and symbols in function area (B)





For buttons on the default displays: See page 23 onwards.

Note

- What buttons and symbols are available depends on the operating mode: Weather-compensated mode, continuous operation, room temperature-dependent mode.
- These symbols are not always displayed, but appear subject to the system version and the operating status.

Symbols







-  Frost protection is active.
- ¹ Central heating with reduced room temperature in weather-compensated mode
 Central heating with reduced flow temperature in continuous operation or room temperature-dependent mode



- ² Central heating with standard room temperature in weather-compensated mode
 Central heating with standard flow temperature in continuous operation or room temperature-dependent mode
- ³ Only for weather-compensated mode and continuous operation:
 Central heating with comfort room temperature in weather-compensated mode
 Central heating with comfort flow temperature in continuous operation
-  Only for weather-compensated mode and continuous operation:
 Holiday program is switched on.
-  Only for weather-compensated mode and continuous operation:
 Holidays at home is switched on.

Buttons and symbols in navigation area (C)

Note

What buttons and symbols are available depends on the operating mode: Weather-compensated mode, continuous operation, room temperature-dependent mode

-  Takes you back to the home screen.
-  Takes you one step back in the menu.
 Or
 Terminates an adjustment in progress.
-  WiFi is switched off: See page 40.
-  Confirms a change.
-  Makes changes in the menu.
-  Calls up the help text.

-  Calls up messages.
-  Calls up the required period for the energy balance.
 Further information: See page 26.
-  Scrolls through the menu.
 Or
 Switches to other display areas, e.g. to the "System overview".

Note

If "DEMO" is displayed in the navigation area, there is no central heating, no DHW heating and no frost protection.

Overview of the "Main menu"

In the **"Main menu"**, you can check and adjust **all** of the settings for the control unit's range of functions.

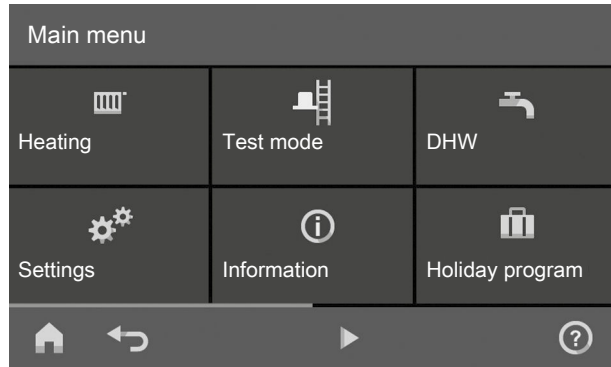





Fig. 6







Call up the **"Main menu"** as follows:





- If the screensaver is active:
Tap anywhere on the screen and then tap .
- From the home screen:
Tap .
- From anywhere in the menu:
Tap  and then .

Menus available in the "Main menu"

Note

What buttons and symbols are available depends on the operating mode: *Weather-compensated mode, continuous operation, room temperature-dependent mode.*

-  **"Heating"**
For more central heating settings, e.g. set temperature values.
Further information: See page 28.
-  **"Test mode"**
For the flue gas inspector **only**
Further information: See page 47.
-  **"DHW"**
For DHW heating settings, e.g. for the  **"DHW temperature"**.
Further information: See page 34.
-  **"Settings"**
For example the  display setting
Further information: See page 37.





-  **"Information"**
For checking operating data
Further information: See page 43.
-  Only for weather-compensated mode and continuous operation:
"Holiday program"
Energy saving function **"Holiday program"**
Further information: See page 32.
-  Only for weather-compensated mode and continuous operation:
"Holidays at home"
"Holidays at home" function
Further information: See page 31.
-  **"Message lists"**
Calls up all pending messages
For further details about messages: See page 44, 45 and 46.
-  **"Service"**
For contractors **only**
You can find the menu overview on page 55.

Operating program

Operating programs for central heating and DHW heating

Note

The operating programs for central heating and DHW heating can be set separately.

Symbol	Operating program	Function
Central heating		
	"Heating"	The rooms of the selected heating circuit are heated in accordance with the specified room temperature or flow temperature and the time program (see chapter "Central heating"). Note <i>In room temperature-dependent mode, a time program for central heating can only be set at the room temperature controller: See operating instructions for room temperature controller.</i>
	"Standby mode"	<ul style="list-style-type: none"> ▪ No central heating ▪ Frost protection for the heat generator is active.
DHW heating		
	"DHW" "ON"	DHW is heated in accordance with the DHW temperature and time program specified (see chapter "DHW heating").
	"DHW" "OFF"	<ul style="list-style-type: none"> ▪ No DHW heating ▪ Frost protection for the DHW cylinder is active.

Special operating programs and functions

▪ "Screed drying"

This function is activated by your contractor. Your screed is dried in line with a set time program (temperature/time profile) suitable for the relevant building materials. Your settings for central heating have no effect on the duration of screed drying (max. 32 days). The system no longer provides DHW heating. The **"Screed drying"** function can be altered or switched off by your contractor.

▪ "External hook-up"

The operating program set at the control unit was changed over by an external device, e.g. an EM-EA1 extension (DIO electronics module). The operating program cannot be changed via the control unit for as long as the external hook-up is enabled.

- Only for weather-compensated mode and continuous operation:

"Holiday program": See page 32.

- Only for weather-compensated mode and continuous operation:

"Holidays at home": See page 31.

Note

The special operating programs and functions are displayed alternately with the room temperature or the flow temperature of the heat generator.

*In the main menu, you can call up the set operating program under **"Information"**: See page 43.*

Procedure for setting a time program

The following explains how to input the settings for a time program. The specifics of the individual time programs can be found in the relevant chapters.

Procedure for setting a time program (cont.)

Time programs and time phases

In the time programs you determine what your heating system should do at what time. To do so, divide the day into sections. These are called **time phases**. Different temperature levels are active within and outside these time phases.

You can set up a time program for the following functions:

Function	Temperature level	
	Within the time phase	Outside the time phase
Central heating	Weather-compensated mode: Your rooms are heated with standard room temperature or comfort room temperature.	Your rooms are heated with reduced room temperature.
	Continuous operation: Your rooms are heated with standard flow temperature or comfort flow temperature.	Your rooms are heated with reduced flow temperature.
	Room temperature-dependent mode: A time program for central heating can only be set at the room temperature controller.  Operating instructions for room temperature controller	
DHW heating	DHW heating is switched on. The water in the DHW cylinder is heated to the set DHW temperature.	DHW heating is switched off.
DHW circulation pump	The DHW circulation pump is switched on.	The DHW circulation pump is switched off.

- The time programs can be set **individually** to be the same, or different, for every day of the week.
- In the main menu, you can check the time programs under ⓘ **"Information"**: See page 43 onwards.

Setting time phases

The procedure is explained using the example of central heating for heating circuit 1 in weather-compensated mode.

You can set up to 4 time phases in each **"Time program"**. For each time phase, you define the start point **"Start"** and the end point **"End"**.





Example:

"Time program" for **"Monday"** for **"Heating circuit 1"**

- Time phase 1:
06:30 to 12:00 with the normal room temperature
- Time phase 2:
15:00 to 20:00 with comfort room temperature

In between these time phases the system heats to a reduced temperature.

Tap the following buttons:

1. **"Heating circuit 1 ✓"** in the menu bar
2. 
3. **"Mo"**
4. 
5.   for the **"Start"** and **"End"** of time phase 1. The bar in the time chart is adjusted.
6.  ² **"Normal"** to select standard room temperature.
7. **+** to add time phase 2.

Procedure for setting a time program (cont.)

8.  for the "Start" and "End" of time phase 2.

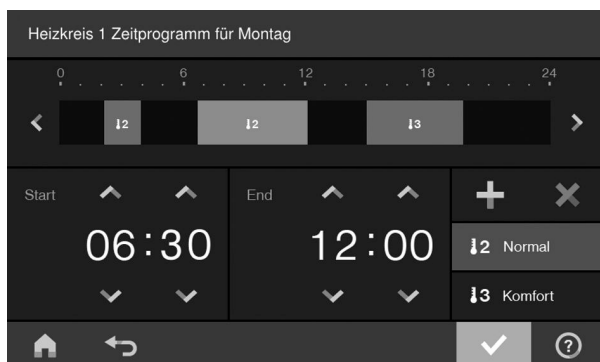



Fig. 7

The bars in the time chart are adjusted.

9.  "Komfort" to select comfort room temperature.

10.  to confirm

11.  to quit the "Time program".

Copying the time program to other days of the week

The procedure is explained using the example of central heating for heating circuit 1 in weather-compensated mode.

The procedure is explained using the example of central heating for heating circuit 1.

Example:

You want to copy the "Monday" "Time program" over to "Thursday" and "Friday".

Tap the following on-screen buttons:

1. "Heating circuit 1 

2. 

3. "Mo"

4. 

5. "Th", "Fr"

6.  to confirm

7.  to quit the time program.

Changing time phases

The procedure is explained using the example of central heating for heating circuit 1 in weather-compensated mode.

The procedure is explained using the example of central heating for heating circuit 1.

Example:

For "Monday", you want to change the start point "Start" of time phase 2 to 19:00 h.

Tap the following on-screen buttons:

1. "Heating circuit 1 



2. 

3. "Mo"

4. 

5.  for time phase 2

6.  for the start point of time phase 2.
The bar in the time diagram is adjusted.

7.  "Normal" for standard room temperature
or
 "Komfort" for comfort room temperature

8.  to confirm

9.  to quit the time program.

Procedure for setting a time program (cont.)

Deleting time phases

The procedure is explained using the example of central heating for heating circuit 1 in weather-compensated mode.

The procedure is explained using the example of central heating for heating circuit 1.

Example:

For **Monday** you want to delete time phase 2.



Tap the following on-screen buttons:

1. "Heating circuit 1  in the menu bar
2. 
3. "Mo" to select the required day
4. 
5.  for time phase 2
6.  to delete the time phase.
7.  to confirm
8.  to quit the time program.

Default display "Heating circuit" or "Continuous operation"

In the **"Heating circuit"** or **"Continuous operation"** default display, you can adjust and check the most frequently used settings:

- +** Raises the room temperature value in weather-compensated mode.
Raises the set flow temperature value in continuous operation or room temperature-dependent mode.
- Lowers the room temperature value in weather-compensated mode.
Lowers the set flow temperature value in continuous operation or room temperature-dependent mode.
-  Sets the **"Heating"** operating program for a heating circuit.

-  To select **"Standby mode"**.
-  Only for weather-compensated mode and continuous operation:
To switch the **"Extended heating"** function on or off.
-  Only for weather-compensated mode and continuous operation:
To call up the **"Time program, heating"** for central heating.

The temperature display represents the selected set room temperature (e.g. 20 °C) or set flow temperature (e.g. 60 °C) for the current time phase.

"DHW" default display

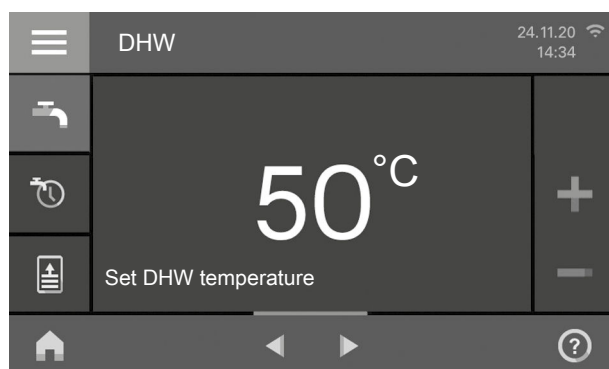



Fig. 8

In the **"DHW"** default display you can carry out the settings and checks you use most frequently:

- +** Raises the DHW temperature value.
- Lowers the DHW temperature value.
-  Turns **"DHW"** **"ON"** / **"DHW"** **"OFF"**.

-  Calls up the **"Time program, DHW"**.
-  Switches **one-off** DHW heating on.

Note

It is not possible to end "one-off DHW heating" sooner.

"Energy cockpit" default display

When you call up the Energy cockpit for the first time, a notification appears.

- The Energy cockpit is opened once you confirm this notification with . The information is not shown again when the energy cockpit is subsequently called up.
- If you tap on Cancel, the notification will appear again the next time you call up the Energy cockpit.

"Energy cockpit" default display (cont.)

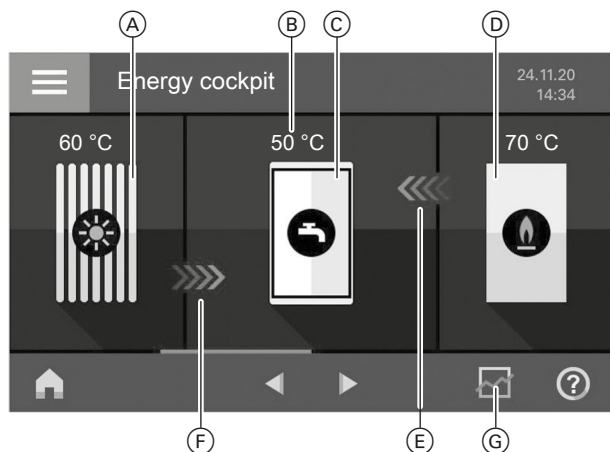







Fig. 9

- Ⓐ Solar collector with collector temperature
- Ⓑ DHW temperature
- Ⓒ DHW cylinder
- Ⓓ Boiler with flow temperature
- Ⓔ DHW cylinder heating by the boiler is active (arrow)
- Ⓕ DHW cylinder heating by the solar thermal system is active (arrow)
- Ⓖ Energy balance checking

The **"Energy cockpit"** provides you with clear information on the energy state of your heating system. The various components present in the system are shown as graphics. Some information on the components is also provided in the default display. For more information, tap on the relevant component. What buttons and symbols are available depends on the system version.

The **"Energy cockpit"** default display enables you to check the following information:



-  To call up the operating data for the solar thermal system.
Further information: See page 24.
-  To call up the temperatures in the DHW cylinder.
Further information: See page 25.
-  To call up the operating data for the heat generator.
Further information: See page 25.
-  Checks the energy balance.
Further information: See page 26.
-  Symbol is animated:
Heating of the DHW cylinder by the solar thermal system or the heat generator is enabled.

Calling up operating data for the solar thermal system

You can call up the following operating data:

- Solar energy yield (Solar energy bar chart): See the following chapter
- Total solar energy generated
- Solar circuit pump operating time
- Solar circuit pump operating state
- Reheating suppression
- Solar stagnation
- Solar circulation pump
- TS3: Buffer temperature
- TS4: Return temperature, heating circuit
- Solar central heating backup
- TS3: DHW preheating





Tap the following buttons:

1. If applicable,  for the **"Energy cockpit"** default display
2. 
3.  for the required check

Calling up the solar energy yield

You can call up the amount of energy generated by your solar thermal system. Values are shown in kilowatt hours.

Tap the following buttons:

1. If applicable,  for the **"Energy cockpit"** default display
2. 
3.  on **"Solar energy bar chart"**
4. Required period :
 - Current month
 - Last month
 - Current year
 - Last year
 The solar energy yield is displayed as a chart with bars.
5. Required period in chart: Day of the week or month
The solar energy yield for the selected period is displayed numerically.

"Energy cockpit" default display (cont.)**Checking the temperatures in the DHW cylinder**

You can carry out the following checks and functions for the DHW cylinder:

- DHW temperatures
- Start one-off DHW heating (only if DHW heating isn't enabled in the current operating program).

Tap the following buttons:

1. If applicable,  for the "Energy cockpit" default display



3.  to start one-off DHW heating by the heat generator. The DHW cylinder is heated to the DHW set temperature.

Note

It is not possible to end "one-off DHW heating" sooner.

4.  to confirm

Starting one-off DHW heating**Tap the following on-screen buttons:**

1. If applicable,  for the "Energy cockpit" default display

Calling up operating data for the heat generator**You can call up the following operating data:**

- Current output
- Hours run
- Burner runtime
- Burner starts
- Power consumption:
 - Power consumed today
 - Power consumed last 7 days
 - Power consumed this month
 - Power consumed last month
 - Power consumed this year
 - Power consumed last year
- Gas condensing boiler fuel consumption:
 - Gas consumption today
 - Gas consumption last 7 days
 - Gas consumption this month
 - Gas consumption last month
 - Gas consumption history:
 - Current month
 - Last month
 - Current year
 - Last year

Note

The consumption figures displayed are not based on metering equipment but instead are computed values. The calculation takes into account the existing system components and the user behaviour (e.g. operating time and utilisation level). Depending on system-specific parameters (e.g. installation altitude and type of flue system), differences may arise between the displayed (computed) and actual consumption values. Due to seasonal climate conditions and other factors, further discrepancies are possible. The value display serves to visualise the energy flow to date, as well as any consumption increases or decreases in relation to specific comparative periods. It cannot be used as a binding basis for billing.

Calling up the fuel consumption history

You can call up the fuel consumption as a chart. Values are shown in cubic metres.

Tap the following buttons:

1. If applicable,  for the "Energy cockpit" default display



3. For example  in "Gas consumption history"

Tap the following buttons:

1. If applicable,  for the "Energy cockpit" default display



3.  for the required check

Default displays



"Energy cockpit" default display (cont.)

4. Required period 
 - Current month
 - Last month
 - Current year
 - Last yearGas consumption is shown as a chart.
 - The gas consumption for central heating is shown in a dark shade.
 - The gas consumption for DHW heating is shown in a light shade.
5. Required period in chart: Day of the week or month
The gas consumption for central heating or DHW heating during the selected period is displayed numerically.

Calling up the energy balance

In conjunction with a solar thermal system, you can call up the current situation regarding solar energy yield and fuel consumption.

Tap the following buttons:

1. If applicable,   for the "Energy cockpit" default display

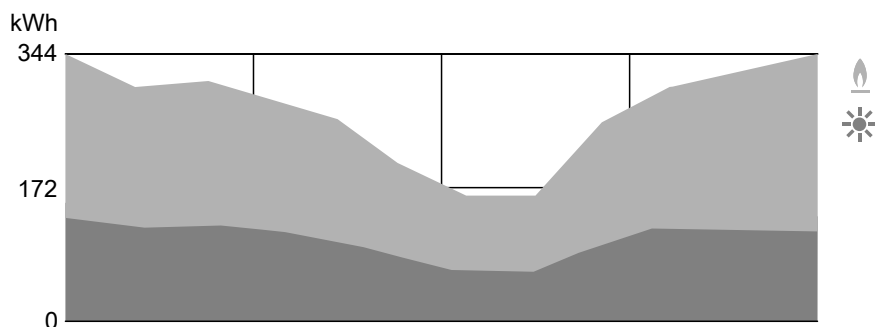





Fig. 10

-  Fuel consumption
-  Solar yield

2. .
3. Required period 
 - Current month
 - Last month
 - Current year
 - Last yearThe energy balance is displayed as a graphic.



"Favourites" default display

In the "Favourites" default display you can call up your own preferred menus. You can add a maximum of 12 menus to Favourites. You can change the selection at any time.

Labelling menus as favourites

Tap the following buttons:

1.   for the "Favourites" default display

2. 
The list of menus available for selection is shown.
3. for all preferred menus
The selection is indicated by .
4.  to confirm

"System overview" default display

What information is available depends on the operating mode: Weather-compensated mode, continuous operation, room temperature-dependent mode.

"System overview" default display (cont.)

Subject to your system equipment and the settings that have been made, you can check the following current system data on the **"System overview"** default display:

- **"System pressure"**
- **"Heat generator"** group:
 - Burner ON/OFF
 - Heat generator flow temperature
- **"General"** group:
 - Only for weather-compensated mode:
 - Outside temperature
- **"Heating circuit ..."** group:
 - Flow temperature, heating circuit

Note
If names have been given to the heating circuits, the allocated name is shown: See chapter "Entering names for heating circuits".
- **"DHW"** group:
 - DHW temperature

- **"Internet"** group:
 - ON/OFF
- **"Solar energy"** group:
 - Collector temperature
 - Solar circuit pump ON/OFF
 - Collector temperature

Tap the following buttons:

1. If applicable, ◀▶ for the **"System overview"** default display
2. **Checking other information:**
 - for other system data in the relevant group.
 - Or
 - ⓘ to call up the **"Information"** menu: See page 43.

Note

Detailed options for checking the individual groups can be found in chapter "Menu overview".

Central heating

Heating circuit selection

Note

In room temperature-dependent mode, only one heating circuit can be operated with the control unit. For this reason, heating circuit selection is not available.

If required, the heating of your interior can be split over several heating circuits.

E.g., one heating circuit for your home, and one heating circuit for your office.

In the menu bar, the heating circuits are designated at the factory as **"Heating circuit 1"**, **"Heating circuit 2"** etc. If names have been given to the heating circuits, the allocated name is shown: See chapter "Naming heating circuits".

- For all central heating settings for heating systems with several heating circuits, first select the heating circuit that you want to change from the **"Heating circuit"** default display.
- If you are only operating one heating circuit, this option is not available.

Tap the following on-screen buttons:

1. If applicable, ◀▶ for the **"Heating circuit"** default display
2. **"Heating circuit 1 ▼"** in the menu bar
3. Required heating circuit

Setting the room temperature for a heating circuit

Factory settings for the temperature levels

Weather-compensated mode:

- Standard room temperature: 20 °C
- Reduced room temperature: 3 °C
- Comfort room temperature: 20 °C

Continuous operation and room temperature-dependent mode:

- Standard flow temperature: 60 °C
- Reduced flow temperature: 20 °C
- Only for continuous operation
Comfort flow temperature: 70 °C

Continuous operation and room temperature-dependent mode

Only change the set values for the flow temperature if the heat supply for central heating is insufficient.

Setting temperature levels for central heating

Note

In room temperature-dependent mode, set the required temperature at your room temperature controller.

Tap the following buttons:

1. If applicable, ◀▶ for the **"Heating circuit"** or **"Continuous operation"** default display
2. If applicable, ▼ in the menu bar for the required heating circuit

3. + for the required value of the relevant temperature level:
 - ↓¹ **"Reduced"**
 - ↓² **"Normal"**
 - ↓³ **"Comfort"**
4. ✓ to confirm

Switching central heating ON or OFF (operating program)

For information on the operating programs, see page 19.

Switching central heating ON or OFF (operating... (cont.))

Tap the following on-screen buttons:

1. If applicable, ◀▶ for the "Heating circuit" or "Continuous operation" default display
2. If applicable, ▼ in the menu bar for the relevant heating circuit or select another submenu for heating circuit and DHW.
3. Highlighted button ☰, ↶ or ⏻.
4.
 - ☰ "Heating" if you want to **start** central heating.
 - ↶ "DHW" if you want to **start** DHW heating.
 - ⏻ "Standby mode" if you want to **stop** central heating or DHW heating.
5. ✓ to confirm

Time program for central heating

Note

In room temperature-dependent mode, a time program for central heating can only be set at the room temperature controller: See operating instructions for room temperature controller.

Setting a time program

Factory settings: **One** time phase from 06:00 to 22:00 for every day of the week

Tap the following on-screen buttons:

1. If applicable, ◀▶ for the "Heating circuit" default display
2. If applicable, ▼ in the menu bar for the relevant heating circuit
3. ⏻
4. Required day of the week
5. ✎
6. Depending on the required change:
 - ▲▼ to change the time phase for a new time phase
 - ⊕ to delete a time phase
 - ◆ to select the time phase if more than one time phase is set.

Note

When adjusting the setting, bear in mind that your system requires some time to heat the rooms to the required temperature.

To continue: See page 19.

Setting the heating curve

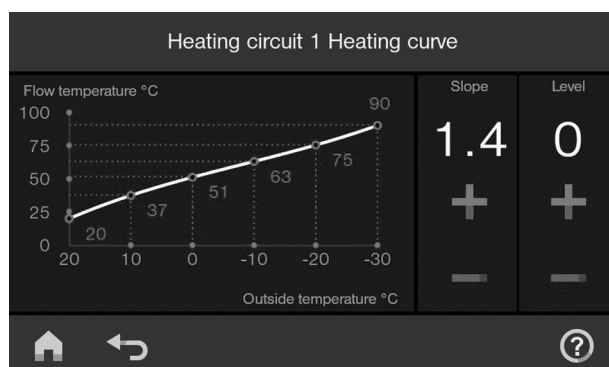

Fig. 11

By setting the "Heating curve", you influence the flow temperature provided by the heat generator.

Note

The heating curve can only be adjusted in weather-compensated mode.



To ensure your rooms are heated optimally at any outside temperature, you can adjust the "Level" and "Slope" of the "Heating curve".



Setting the heating curve (cont.)

Factory settings:

- "Slope": 1.4
- "Level": 0

Tap the following on-screen buttons:

1. 
2.  "Heating"
3. Required heating circuit, e.g.  "Heating circuit 1"

4.  "Heating curve"
5.  for the required value for "Slope" and "Level" respectively
The graph displayed clearly shows the change in the "Heating curve" as soon as you alter the value for the "Slope" or "Level".
6.  to confirm

Tips for setting the "Heating curve"

Room temperature behaviour	Remedy
The home is too cold during the winter.	Set the "Slope" to the next level up.
The home is too warm during the winter.	Set the "Slope" to the next level down.
The home is too cold during the spring/autumn and winter.	Set the "Level" to a higher value.
The home is too warm during the spring/autumn and winter.	Set the "Level" to a lower value.
The home is too cold during the spring/autumn but warm enough during the winter.	Set the "Slope" to the next level down and "Level" to a higher value.
The home is too warm during the spring/autumn but warm enough during the winter.	Set the "Slope" to the next level up and "Level" to a lower value.

Temporarily adjusting the room temperature

Note

Only for weather-compensated mode and continuous operation.

Switch on the "Extended heating" function if you want to heat your home with **standard room temperature/flow temperature** or **comfort room temperature/flow temperature** during a time phase with reduced room temperature.

Your home will be heated with the temperature of the last active time phase for standard room temperature/flow temperature or comfort room temperature/flow temperature.

Note

DHW heating is enabled during the "Extended heating" function:

If the DHW temperature is below the set DHW value, the DHW cylinder is heated first, then the rooms are heated.

Switching on "Extended heating"

Tap the following buttons:

1. If applicable,  in the menu bar for the required heating circuit
2. 
The temperature of the last active time phase for the standard room temperature/flow temperature or comfort room temperature/flow temperature will be selected.

Temporarily adjusting the room temperature (cont.)

Switching off "Extended heating"

The function ends automatically when switching to the next time phase for the standard room temperature/flow temperature or comfort room temperature/flow temperature.

2. ☰

Tap the following buttons to terminate "Extended heating" early:

1. If applicable, ✓ in the menu bar for the required heating circuit

Adjusting the room temperature for longer periods at home

Note

Only for weather-compensated mode and continuous operation.

If you are continuously at home for one or more days but do not want to change the time program, select the function "Holidays at home" 🏠, e.g. on public holidays or when the children are on school holidays.

The "Holidays at home" 🏠 function has the following effects:

- The room temperature during the periods between the set time phases is raised to the set value of the first time phase of the day: From reduced room temperature to standard room temperature or comfort room temperature.
- If no time phase is active before 0:00, your rooms are heated to the reduced room temperature until the next time phase becomes active.

- DHW heating is active.

- The "Holidays at home" function starts and ends according to the set times for the start date and end date.

Note

- As long as the "Holidays at home" function is switched on, the default display shows "Holidays at home" and the set start date and end date.
- If "Detached house" was selected by your contractor during commissioning, the function is adopted for all heating circuits.

Example

For Monday and Tuesday, 2 time phases are set respectively.

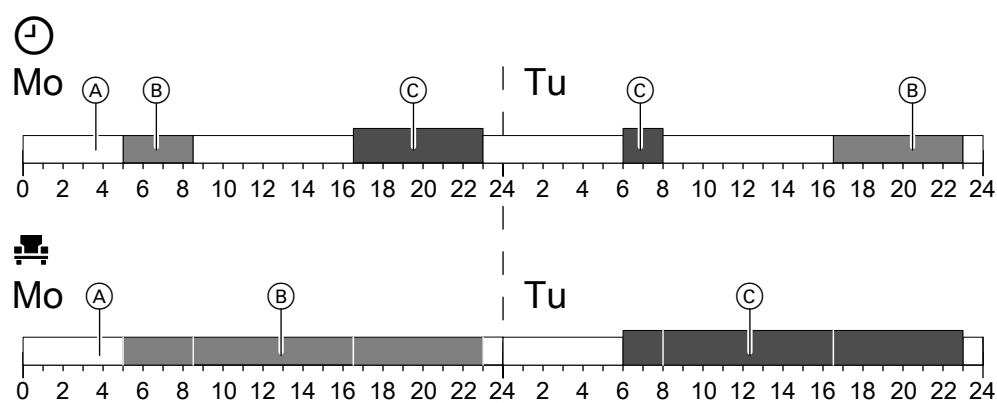

Fig. 12

⊙ Temperature levels in line with the set time program

🏠 Temperature level if "Holidays at home" is active

Ⓐ Reduced room temperature

Ⓑ Standard room temperature

Ⓒ Comfort room temperature

Adjusting the room temperature for longer... (cont.)

Switching on "Holidays at home"

Tap the following buttons:

1. 
2.  "Holidays at home"
3. Use  to select the required heating circuit
4.   for "Start" and "End"
5.  to confirm

Switching off "Holidays at home"

Tap the following buttons:

1. 
2.  "Holidays at home"
3. Use  to select the required heating circuit
4. 



Saving energy during long periods of absence

Note

Only for weather-compensated mode and continuous operation.

To save energy during long periods of absence, select "Holiday program" .

The holiday program has the following effects:







- **Central heating:**
 - For heating circuits in the  "Heating" operating program:
The rooms are heated to the set reduced room temperature.
 - For heating circuits in the  "Standby mode" operating program:
No central heating: Frost protection for the heat generator and the DHW cylinder is enabled.
- **DHW heating:**
No DHW heating; frost protection for the DHW cylinder is enabled.
- The holiday program starts at 00:00 h on the first day of your holiday and ends at 23:59 h on the final day.

Note

- As long as the "Holiday program" function is switched on, the selected first and last day of the holiday are shown in the "Heating circuit" and "Holiday program" default display.
- If "Detached house" was selected by your contractor during commissioning, the holiday program is switched on for all heating circuits.
- If "Apartment building" was selected by your contractor during commissioning, DHW heating will only be switched off if all heating circuits are in the holiday program.

Switching on the "Holiday program"

Tap the following on-screen buttons:

1. 
2.  "Holiday program"
3. Use  to select the required heating circuit
4.   for "First day of holiday" and "Last day of holiday"
5.  to confirm

Switching off the "Holiday program"

Tap the following on-screen buttons:

1. 
2.  "Holiday program"
3. Use  to select the required heating circuit

Saving energy during long periods of absence (cont.)

4. 

DHW heating

DHW temperature

Factory settings: 50 °C

Note

For reasons of good hygiene, you should not set the DHW temperature lower than 50 °C.

Tap the following buttons:

1.  for the "DHW" default display



2.  for the required value



3.  to confirm

Switching DHW heating on or off (operating program)

If you switch off DHW heating, no water can be heated. This also applies for the function "One-off DHW heating outside the time program".

Tap the following on-screen buttons:

1. If applicable,  for the "DHW" default display
2. Highlighted button  or 

3.  "ON" if you want to **start** DHW heating.
 "OFF" if you want to **stop** DHW heating.

For information on the operating program: See page 19.



Time program for DHW heating

Setting a time program





Factory settings: 05:30 to 22:00

You can change the time program **individually** in accordance with your requirements.

Tap the following on-screen buttons:

1. If applicable,  for the "DHW" default display
2. 
3. Required day of the week
4. 

5. Depending on the required change:

-  to change the time phase
-  for a new time phase
-  to delete a time phase.
-  to select the time phase if more than one time phase is set.

Note

- The DHW is not heated between the time phases. Frost protection for the DHW cylinder is enabled.
- When setting time programs, bear in mind that your system requires some time to heat the DHW cylinder to the required temperature.

To continue: See page 19.

Setting a time program for the DHW comfort function

(Function only for combi boilers with plate heat exchanger for DHW heating)

Factory settings: 05:30 to 22:00 h

Note

With a "Combi boiler", the "DHW comfort function" is active during the set time phases (plate heat exchanger is kept at temperature). The time phases need to be deleted to switch off the comfort function.

Time program for DHW heating (cont.)

You can change the time program for the comfort function **individually** in accordance with your requirements.

Tap the following on-screen buttons:

1. If applicable, ◀▶ for the "DHW" default display
2. 🕒

3. Required day of the week

4. ✍

5. Depending on the required change:

- ▲ ▼ to change the time phase
- + for a new time phase
- ✕ to delete a time phase.
- ◀▶ to select the time phase if more than one time phase is set.

Setting the time program for the DHW circulation pump

You can change the time program **individually** in accordance with your requirements.

Tap the following on-screen buttons:

1. ☰
2. 🚰 "DHW"
3. 🕒 "Time program, DHW circulation"
4. Select day of week.
5. ✍

6. Depending on the required change:

- ▲ ▼ to change the time phase
- + for a new time phase
- ✕ to delete a time phase.
- ▶▶ to select the time phase if more than one time phase is set.

Note

Between the time phases the DHW circulation pump remains off.

To continue: See page 19.

One-off DHW heating outside the time program

If you require hot water outside the set time phases, switch on "One-off DHW heating" 📄. The DHW cylinder is heated once to the set DHW temperature.

This function has a higher priority than other functions for DHW heating, such as the time program.

Switching on one-off DHW heating

Tap the following on-screen buttons:

1. If applicable, ▶▶ for the "DHW", "Energy cockpit" or "Favourites" default display

2. 📄

3. ✓ to confirm

Switching off one-off DHW heating

"One-off DHW heating" 📄 ends as soon as the set DHW temperature has been reached.

Note

It is not possible to stop DHW heating sooner!

Increased DHW hygiene

You can heat the water in the DHW cylinder to above 60 °C once a week or for an hour every day. This function is regularly carried out at the specified time.



Danger

High DHW temperatures can cause scalding, e.g. if the DHW temperature is above 60 °C. Mix with cold water at the draw-off points.

Increased DHW hygiene (cont.)

Switching on increased DHW hygiene

Tap the following buttons:

1. 
2.  "DHW"
3.  "Hygiene function"
4.   for the starting time "**Start**"
5. Select the required day or "Daily"
The selection is highlighted.
6.  to confirm



Switching off increased DHW hygiene

Tap the following buttons:

1. 
2.  "DHW"
3.  "Hygiene function"
4. Deselect the day or "Daily"
5.  to confirm

Switching DHW scald protection on/off

Tap the following buttons:

1. 
2.  "DHW"
3. "Scald protection"
4. "On" or "Off"
5.  to confirm

Note

With scald protection switched off, a set DHW temperature of over 60 °C can be selected, depending on the heat generator. There is an increased risk of scalding!

Disabling operation





You can lock the controls in 2 steps:

Stage 1 All functions on the default displays are operable. Emissions test mode can be switched on. Message lists are displayed. All other functions are disabled.

Stage 2 All functions are disabled. Emissions test mode can be switched on.

Tap the following on-screen buttons:



1. 
2.  "Settings"

3.  "Lock panel"
4.  "Lock everything"
Or
 "Only home screen operable"
5. Enter the password "viessmann".
6.  to confirm

The password can be changed: See page 37.







Unlocking the controls

Tap the following on-screen buttons:

1. Any on-screen button
"Panel locked" is displayed.
2. 
"Do you want to unlock the operation?" is displayed.
3. 
An entry field and keyboard appear.
4. Enter the password "viessmann" or the password you have specified.
5.  to confirm

Changing the password for the "Lock panel" function

Tap the following on-screen buttons:

1. 
 2.  "Settings"
 3.  "Change password"
 4. Enter the current password.
 5.  to confirm
 6. Enter the new password (1 to 20 characters).
- Note**
You will not be required to confirm the new password.
7.  to confirm
Information is displayed.
 8.  to confirm the note

Setting the display brightness

You can adjust the display brightness for operation and for standby separately.

Tap the following buttons:

1. 
2.  "Settings"
3.  "Display setting"
4.  "Brightness, operation"
Or
 "Brightness, standby"
5.   for the required value
6.  to confirm

Further adjustments







Switching the Lightguide on and off

Dependent upon the design of the heat generator, at the lower or upper edge of the control unit, a Lightguide is displayed.
With various displays, the Lightguide explains the functions of the control unit.

Meaning of the display:

- Lightguide is illuminated constantly:
You are operating the control unit. Every input operation is confirmed by a brief flashing.
- Lightguide flashes quickly:
There is a fault in the system.
- Lightguide pulsates slowly:
Display is in standby mode.
You can switch this function on or off as you wish.

Tap the following buttons:

1. 
2.  "Settings"
3.  "Lightguide standby mode"
4.  "ON"
Or
 "OFF"
5.  to confirm

Entering names for heating circuits

Note

Only for weather-compensated mode and continuous operation.





You can name all heating circuits individually, e.g. "Ground floor".

Note

The abbreviations 1, 2, 3, 4 will be retained in the default display.

Tap the following on-screen buttons:

1. 

2.  "Settings"
3.  "Rename heating circuits"
4. Required heating circuit, e.g.  "Heating circuit 1"
5. Type in the required name, e.g. "Ground floor" (1 to 20 characters).
6.  to confirm

The name assigned to the relevant heating circuit is shown in the main menu.





Setting the "Time" and "Date"

The "Time" and "Date" are set at the factory. If your system has been shut down for a prolonged period, you may need to reset the "Time" and "Date".

Tap the following buttons:

1. 

2.  "Settings"



3.  "Date and time"
4.  "Date"
Or
 "Time"
5.  for the required value
6.  to confirm

Automatic "Summer/wintertime" changeover

The automatic changeover from summer/wintertime is factory-set.
In this menu you can switch the changeover from summer/wintertime on and off.

Tap the following buttons:

1. 

2.  "Settings"
3.  "Date and time"
4. "Time changeover"
5.  for "ON" or "OFF"

Automatic "Summer/wintertime" changeover (cont.)

6. ✓ to confirm

Setting the "Language"

Your contractor will have set the display language during commissioning. You can change the language.

Tap the following on-screen buttons:

1. ☰
2. ⚙️ "Settings"

3. 🗣️ "Language"
4. Required language
5. ✓ to confirm

Setting "Units"

You can adjust all available units, e.g. for the temperature, date, pressure, etc.

Tap the following buttons:

1. ☰
2. ⚙️ "Settings"

3. 📏 "Units"
4. Select e.g. °C for the temperature.
5. ✓ to confirm

Entering the contractor's contact details

You can enter your contractor's contact details. These can then be called up in the ⓘ "Information" menu.

Tap the following on-screen buttons:

1. ☰
2. ⓘ "Information"

3. 📞 "Contractor contact details"
4. Relevant entry field
5. Enter your contractor's contact details into the individual boxes.
6. ✓ to confirm

Setting the home screen

Note

Which default displays are available depends on the operating mode: Weather-compensated mode, continuous operation, room temperature-dependent mode.

You can choose from the following default displays as your home screen:

- "Heating circuit" or "Continuous operation"
- "DHW"
- "System overview"
- "Energy cockpit"
- "Favourites"

Tap the following on-screen buttons:

1. ☰

2. ⚙️ "Settings"
3. 🏠 "Selecting the default display"
4. Required display
5. ✓ to confirm



Note

Tap on 🏠 to call up the selected home screen.

Further adjustments

Setting the gross calorific value and gas volume correction factor for consumption billing

Tap the following buttons:

1. 
2.  "Settings"
3. "Energy cockpit"
4. Select gross calorific value or gas volume correction factor

5. Enter value
6.  to confirm

Note

The value can be found on the gas bill. The values entered are used to help calculate the gas consumption.



Switching on wireless connection to the remote control

Note

Low power radio is a wireless connection for data transfer, e.g. via a remote control unit.
Your heating contractor can connect your heat generator with Viessmann accessories via low power radio.

With weather-compensated mode, you can connect your remote control to the control unit for wireless data transfer via low power radio.

Tap the following on-screen buttons:

1. 
2.  "Settings"
3.  "Low power radio ON/OFF"

4. "ON"
5.  to confirm

Note

The low power radio credentials can be called up in the service menu under menu point "Diagnosis"/"RF module": RF module "IC" and "EUI-64"
See installation/service instructions







Switching internet access on or off

You can control your system remotely via the internet using an app. To do this, establish an internet connection via WiFi (2.4 gigahertz): See the following chapter. The required credentials for internet access to the control unit via app can be found on the adjacent label:



Switching WiFi on or off

Tap the following on-screen buttons:

1. 
2.  "Settings"
3.  "Internet"
4. "WiFi operating mode"
5.  "OFF" if you want to **switch off** the WiFi.
Or
 "Internet" if you want to **switch on** the WiFi.
6.  to confirm



Switching internet access on or off (cont.)

Establishing a WiFi connection

Note







Prerequisite: WiFi is switched on.

Tap the following on-screen buttons:

1. 
2.  "Settings"
3.  "Internet"
4. "Network selection"
 - Available WiFi networks are displayed.
5. Select WiFi.

Note

Use  to refresh the list of available WiFi networks.

6.  to confirm
7. If your selected WiFi is not protected :
 -  to acknowledge the connection message
 - Or
 - If your selected WiFi is protected :
 - Enter the password (maximum 40 characters).
 -  to confirm your password
8.  to acknowledge the information regarding internet use
The default display shows .





Note



- If the connection was not established, an error message is shown.
- An internet connection only exists if the selected WiFi is connected to the internet. Check your WiFi settings if required.

Static IP addressing

Prerequisite: Your WiFi is configured so that the subscriber addresses in the network (IP addresses) are not automatically assigned.

Tap the following on-screen buttons:

1. 
 2.  "Settings"
 3.  "Internet"
 4. "Network selection"
 5. Available WiFi networks are displayed.
- Note**
Tap  to refresh the list of available WiFi networks.
6. Select the network.

7. 
8. "STATIC" for static IP addressing
9.  to confirm
10. Enter network data:
 - IP address
 - Subnet mask
 - Standard gateway
 - Primary DNS server
 - Secondary DNS server
11.  to confirm

Note

An internet connection only exists if the selected WiFi is connected to the internet. Check your WiFi settings if required.

Switching off the display screen for cleaning

If you want to clean the display screen, you can deactivate it for 30 seconds. This prevents unintentional operation.

Clean the display with a microfibre cloth.

Further adjustments

Switching off the display screen for cleaning (cont.)

Tap the following on-screen buttons:

1. 

2.  "Settings"

3.  "Clean screen"

The display is deactivated. A countdown begins.

Restoring factory settings

You can reset all entries and values to their factory settings.

Note

If the heating circuits have been given names, the assigned names will be retained: See page 38.

Settings and values that are reset with all operating modes:

- Standard room temperature or standard flow temperature
- Reduced room temperature or reduced flow temperature
- Operating program
- DHW temperature
- Time program for DHW heating
- Time program for DHW circulation pump
- Only for weather-compensated mode
Heating curve slope and level

Settings and values that are additionally reset with weather-compensated mode or continuous operation:

- Comfort room temperature or comfort flow temperature
- Time program for central heating
- The "Extended heating" function is switched off.
- "Holiday program" and "Holidays at home"
- Only for weather-compensated mode
Heating curve slope and level

Tap the following on-screen buttons:

1. 

2.  "Settings"

3.  "Factory settings"

4.  to confirm

Calling up help messages

You can call up help messages relating to the displays and functions.

Tap the following on-screen buttons:







1.  to call up the help messages.



2.  to return to the previous screen.

Checking information

Depending on the system equipment level and the settings made, you can check current system data, e.g. temperatures.

The system data is divided into the following groups:



-  General
-  Burner
-  DHW
-  Heating circuit 1
Only for weather-compensated mode or continuous operation:
-  Heating circuit 2
etc.
-  Solar energy
-  Contractor contact details

-  Internet
-  Open source license
Calls up the licence for the programming unit.

Note

If names have been given to the heating circuits, the allocated name is shown: See page 38. Detailed options for checking the individual groups can be found in chapter "Menu overview".

Tap the following buttons:





1. 
2.  "Information"
3. Required group

Checking licences for the integrated communication module

Switch on the "Access point" of the appliance so that you can call up online legal information, such as open source licences.

Switching on access point

Tap the following on-screen buttons:

1. 
2.  "Settings"
3.  "Internet"
4. "WiFi operating mode"
5.  "Access Point Status"
6. Follow the instructions in the mobile device app.
7.  to confirm

Calling up the license information for third party components

Requirement: Access point must be switched on.

Tap the following buttons:

1. Call up the WiFi settings on your mobile device.
2. Connect your mobile device to the WiFi "Viessmann-**<xxxx>**".
A password prompt will be displayed.
3. Enter the WPA2 network key as the password for the "Viessmann-**<xxxx>**" WiFi.
4. With your connected mobile device, open **http://192.168.0.1** in your internet browser.

Note

The WPA2 network key can be found on the label: See chapter "Switching internet access on or off".

Checking licences for the integrated... (cont.)

5. Follow the link "**Third party Components Licences**".

Third party software

1 Overview

This product contains third party software, including open source software. You are authorised to use this third party software subject to compliance with the relevant licensing terms as provided in this document. A list of used third party software components and of license texts can be accessed by connecting your boiler, like it is mentioned in the manual.

2 Acknowledgements

Linux® is the registered trademark of Linus Torvalds in the U.S. and other countries. This product includes software developed by the OpenSSL Project for use in the OpenSSL Toolkit (<http://www.openssl.org/>). This product includes cryptographic software written by Eric Young (eay@cryptsoft.com) and software written by Tim Hudson (tjh@cryptsoft.com).

3 Disclaimer

The open source software contained in this product is distributed WITHOUT ANY WARRANTY; without even the implied warranty of MERCHANTABILITY or FITNESS FOR A PARTICULAR PURPOSE. The single licences may contain more details on a limitation of warranty or liability.

5 Contact information

Viessmann Climate Solutions SE
D-35108 Allendorf
Germany
Fax +49 64 52 70-27 80
Phone +49 64 52 70-0
open-source-software-support@viessmann.com
www.viessmann.de

4 How to obtain the source code

The software included in this product may contain copyrighted software that is covered under a licence requiring us to provide the source code of that software, such as the GPL or LGPL. To obtain the complete corresponding source code for such copyrighted software, please get in touch with us via the contact information provided in section 5 below indicating the build number you will find in the licensing information section, which can be accessed as outlined in this document. This offer is not limited in time and is valid to anyone in receipt of this information.

Checking service messages

Your contractor can set service intervals. When these service intervals are exceeded, a service message is displayed automatically: "**Service**" and . If available, your heating contractor's contact details will be displayed.

Tap the following on-screen buttons:





 flashes in the navigation area.

Checking service messages (cont.)

Calling up a service message

Tap the following buttons:

1.  in the navigation area.
If fault messages are also present in your system, they and any further messages can be called up with  "**Faults**", "**Service messages**".
2. "**Service messages**"
The service messages appear in a list.
3. Tapping on ? calls up information on the system's characteristics.
Tips on measures you can take yourself **before** notifying your contractor are displayed.
4. Make a note of the service message number. For example: **P.1 "Interval until the next service"**.
This enables the contractor to be better prepared and may save you unnecessary travelling costs.
5. Please notify your heating contractor.
6.  for acknowledging a service.



Note

If the service cannot be carried out until a later date, the service message will be displayed again the following Monday.

Checking fault messages

If your system has developed faults, "**Fault**" and  are displayed. The Lightguide flashes even when switched off: See chapter "Switching the Lightguide on and off".

Tap the following buttons:



- 
 flashes in the navigation area.

Note

- *If you have connected a message facility to alert you to fault messages (e.g. a buzzer), this is deactivated when the fault message is acknowledged.*
- *If troubleshooting cannot be carried out until a later date, the fault message will be displayed again the following day at 07:00. The message facility is switched on again.*

Calling up a fault message

Tap the following buttons:

1.  in the navigation area.
If service messages are also present in your system, they and any further messages can be called up with  "**Faults**", "**Service messages**".
2. "**Faults**"
The fault messages appear in a list.
3. Tapping on ? calls up information on the system's characteristics.
Tips on measures you can take yourself **before** notifying your contractor are displayed.
4. Make a note of the fault number and the cause of the fault. For example: **F.160 "Communication error CAN bus"**.
This enables the contractor to be better prepared and may save you unnecessary travelling costs.
5. Please notify your heating contractor.
6.  to acknowledge the fault.



Danger

If faults are not rectified, they can have life threatening consequences.
Do not acknowledge fault messages several times in quick succession. Please notify your contractor if a fault occurs. Your contractor will be able to analyse the cause and rectify the fault.



Resetting the burner after a burner fault

If the burner is locked due to a fault, you can reset the burner.

Checks

Checking fault messages (cont.)

Tap the following on-screen buttons:

1.  Further information is shown.
2. "Reset"
3.  to confirm
The burner is reset and will restart.



Danger

If faults are not rectified, they can have life threatening consequences.

Do not reset the burner several times in quick succession. Immediately notify your contractor if a burner fault occurs. Your contractor will be able to analyse the cause and rectify the fault.

Checking message lists

Tap the following on-screen buttons:

1. 
2.  "Message lists"

3. If the relevant messages are present:

- "Status"
- "Warnings"
- "Information"
- "Faults"
- "Service messages"

Emissions test mode

The emissions test mode for testing flue gas must only be activated by your flue gas inspector during the annual inspection.





If possible, have the emissions test carried out during the heating season.

Note

The flue gas inspector can activate emissions test mode even if the control panel is locked.

Starting emissions test mode

Tap the following buttons:

1. 
2.  "Test mode"
3. 
4. Follow the instructions on the display.
If test mode is possible, the burner starts. The flow temperature of the heat generator is shown on the display. The  symbol is displayed.

Note

Ensure adequate heat transfer during emissions test mode.

Stopping emissions test mode

- Automatically after 30 minutes
Or
- Tap .

Switching the system off

Shutting down heat generation with frost protection monitoring ("Standby mode")

For **every** heating circuit, select the "**Standby mode**" operating program and switch off DHW heating: See page 28 and 34.

- No central heating
- No DHW heating
- Frost protection for the heat generator and the DHW cylinder is active.

Note

- *All circulation pumps connected to the control unit are briefly started every 24 hours to prevent them from seizing up.*
- *The diverter valves are switched over at regular intervals.*

Shutting down heat generation without frost protection monitoring

- No central heating
- No DHW heating
- Frost protection for the heat generator and the DHW cylinder is **not** enabled.

Note

- *As they are not being supplied with power, the circulation pumps and diverter valves may seize up.*
- *If your system has been shut down for a prolonged period, you may have to reset the "**Time**" and "**Date**": See page 38.*

1. Turn off the ON/OFF switch: See page 49).

2. Close the gas shut-off valve.



Please note

If outside temperatures of below 3 °C are expected, take appropriate measures to protect the system from frost.

If this is the case, please contact your heating contractor.

Switching on the system

Vitodens 200-W

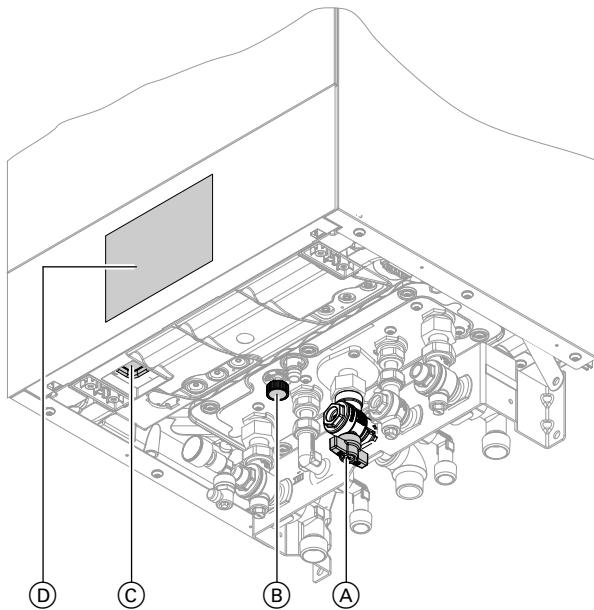

Fig. 13

Note

The control unit can be located at the top or bottom.

- (A) Gas shut-off valve
- (B) Drain & fill valve
- (C) ON/OFF switch
- (D) System pressure (shown on display)

Vitodens 222-W

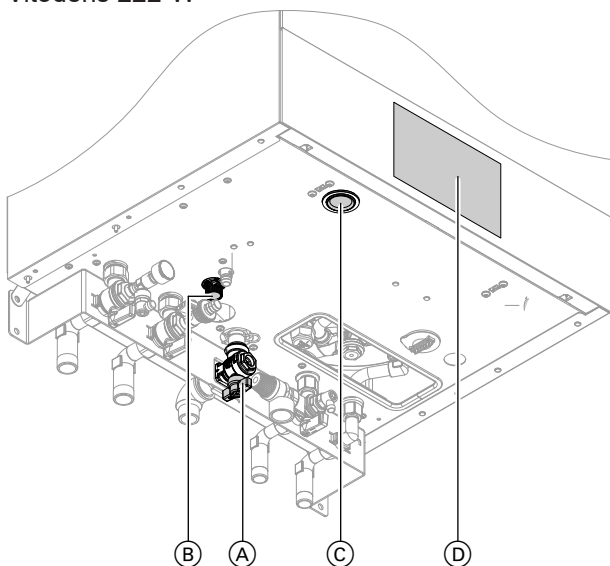

Fig. 14

Note

The control unit can be located at the top or bottom.

- (A) Gas shut-off valve
- (B) Drain & fill valve
- (C) ON/OFF switch
- (D) System pressure (shown on display)

Vitodens 222-F and Vitodens 242-F

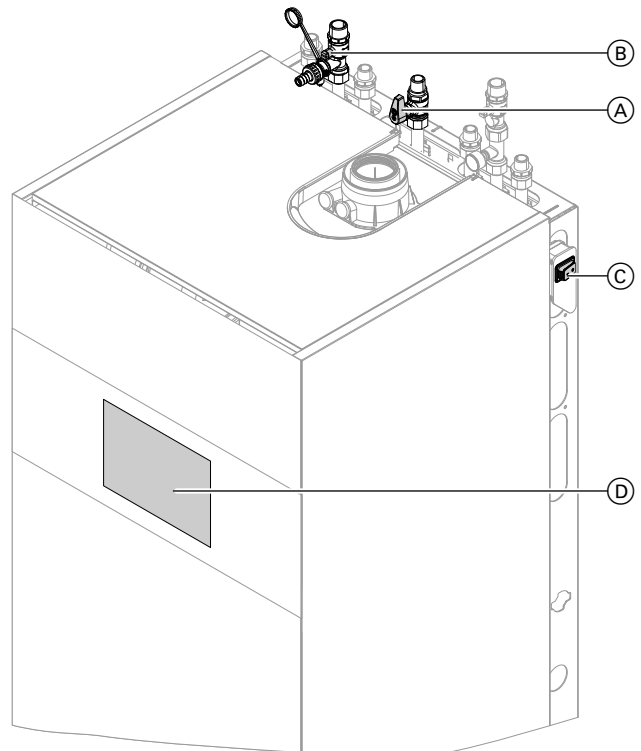

Fig. 15 Example with connections at the top

- (A) Gas shut-off valve
- (B) Drain & fill valve
- (C) ON/OFF switch
- (D) System pressure (shown on display)

Ask your contractor about the following:

- Required system pressure
- Position of ventilation apertures in the installation room, if applicable

1. Open gas shut-off valve (A).
2. Check whether the power supply to your system is switched on, e.g. at a separate MCB/fuse or mains isolator.

Note



The power supply to the system was switched on by your heating contractor during commissioning. If possible, do not interrupt the power supply, even when the system is in standby mode.

3. Turn ON/OFF switch (C) on.
 - After a short while, the home screen is shown on the display.
 - The Lightguide is illuminated constantly. Your system and, if installed, your remote controls are ready for operation.

Switching on the system (cont.)

4. Check the system pressure:
 -  for the "**System overview**" default display
 - If the pressure shown is below 1.0 bar:
Please top up with water or notify your heating contractor.

Rooms are too cold

Cause	Remedy
The heat generator is switched off.	<ul style="list-style-type: none"> ▪ Turn on the ON/OFF switch: See page 49. ▪ Switch ON the power supply to your system, e.g. at a separate MCB/fuse or mains isolator.
<ul style="list-style-type: none"> ▪ Incorrect control unit settings. ▪ The remote control (if installed) or the room temperature controller (if installed) is set incorrectly.  Operating instructions, for the remote control unit or room temperature controller	<p>Central heating must be enabled.</p> <p>Check the settings and correct if required:</p> <ul style="list-style-type: none"> ▪ Operating program: See page 19. ▪ Room temperature/flow temperature: See page 28. ▪ Time: See page 38. ▪ Time program for central heating: See page 29. ▪ Only for weather-compensated mode: Heating curve: See page 29. ▪ Only for weather-compensated mode or continuous operation: The holiday program is switched on: See page 32.
The DHW cylinder is being heated.	Wait until the DHW cylinder has been heated up. Reduce the DHW draw-off rate or temporarily reduce the set DHW temperature if necessary.
No fuel.	Open the gas shut-off valve. If necessary, check with your gas supply utility.
" Burner fault " is displayed.	<p>Reset the burner: See page 45.</p> <p> Danger If faults are not rectified, they can have life threatening consequences. Do not reset the burner several times in quick succession. Immediately notify your contractor if a burner fault occurs. Your contractor will be able to analyse the cause and rectify the fault.</p>
" Fault " is displayed.	Check what type of fault it is. Make a note of the fault message and acknowledge the fault: See page 45. You may have to notify your contractor.
" Screed drying " is switched on.	<p>No action required.</p> <p>After expiry of the screed drying time, the selected operating program is switched on.</p>

Rooms are too hot

Cause	Remedy
<ul style="list-style-type: none"> ▪ Incorrect control unit settings. ▪ The remote control (if installed) or the room temperature controller (if installed) is set incorrectly.  Operating instructions, for the remote control unit or room temperature controller	<p>Check the settings and correct if required:</p> <ul style="list-style-type: none"> ▪ Operating program: See page 19. ▪ Room temperature/flow temperature: See page 28. ▪ Time: See page 38. ▪ Time program for central heating: See page 29. ▪ Only for weather-compensated mode: Heating curve: See page 29. ▪ Only for weather-compensated mode or continuous operation: The "Holidays at home" function is switched on: See page 31.
"Fault" is displayed.	Check what type of fault it is. Make a note of the fault message and acknowledge the fault: See page 45. You may have to notify your contractor.
"Screed drying" is switched on	No action required. After expiry of the screed drying time, the selected operating program is switched on.

There is no hot water

Cause	Remedy
The heat generator is switched off.	<ul style="list-style-type: none"> ▪ Turn on the ON/OFF switch: See page 49. ▪ Switch ON the power supply to your system, e.g. at a separate MCB/fuse or mains isolator.
<ul style="list-style-type: none"> ▪ Incorrect control unit settings. ▪ The remote control (if installed) or the room temperature controller (if installed) is set incorrectly.  Operating instructions, for the remote control unit or room temperature controller	<p>DHW heating must be enabled.</p> <p>Check the settings and correct if required:</p> <ul style="list-style-type: none"> ▪ Operating program: See page 19. ▪ DHW temperature: See page 34. ▪ Time: See page 38. ▪ Time program for DHW heating: See page 34. ▪ Only for weather-compensated mode or continuous operation: The holiday program is switched on for all heating circuits: See page 32.
No fuel.	Open the gas shut-off valve. If necessary, check with your gas supply utility.
"Fault" is displayed.	Check what type of fault it is. Make a note of the fault message and acknowledge the fault: See page 45. You may have to notify your contractor.
"Screed drying" is switched on	No action required. After expiry of the screed drying time, the selected operating program is switched on.
"Filter strainer" dirty (only gas condensing combi boilers).	Have the filter strainer checked/replaced by a heating contractor.

The DHW is too hot

Cause	Remedy
Incorrect control unit settings.	Check and correct the set DHW temperature if required: See page 34.
The hygiene function is switched on.	Wait until the hygiene function has been completed.
DHW temperature for solar DHW heating is set too high.	Have your contractor change the setting.

"Fault" is displayed

Cause	Remedy
System fault	Proceed as described on page 45.

 and "Service" are displayed

Cause	Remedy
The time for a service as specified by your contractor has arrived.	Proceed as described on page 44.

"Panel locked" is displayed

Cause	Remedy
The control panel is locked.	Unlock it: See page 37.

"External hook-up" is displayed

Cause	Remedy
The set operating program was changed over by an external device, e.g. an EM-EA1 extension (DIO electronics module): See page 19.	No action required. Once the external changeover no longer applies, the set operating program is switched on again.

Maintenance

Cleaning

The appliances can be cleaned with a commercially available domestic cleaning agent (non-scouring). Clean the surface of the programming unit with a microfibre cloth.

Inspection and maintenance

The inspection and maintenance of a heating system is prescribed by the Buildings Energy Act [Germany] and the DIN 4755, DVGW-TRGI 2018 and DIN EN 806-5 standards.

Regular maintenance ensures trouble-free, energy efficient, environmentally responsible and safe heating operation. Your heating system must be serviced by an authorised contractor at least every 2 years. For this, it is best to arrange an inspection and maintenance contract with your local contractor.

Appliance

Increased contamination raises the flue gas temperature and thereby increases energy losses. We recommend the appliance is cleaned annually.

DHW cylinder

Standard EN 806-5 specifies that maintenance and cleaning should be carried out no later than 2 years after commissioning and as required thereafter. Only a qualified contractor should clean the inside of the DHW cylinder and the DHW connections.

If any water treatment equipment (e.g. a sluice or injection system) is installed in the cold water supply of the DHW cylinder, ensure this is refilled in good time. For this, observe the manufacturer's instructions.

Safety valve (DHW cylinder)

The function of the safety valve must be checked every six months by the user or a contractor through venting (see valve manufacturer's instructions). The valve seat may become contaminated. Water may drip from the safety valve during a heat-up process. The outlet is open to the atmosphere.



Please note

Overpressure can cause damage.
Do not close the safety valve.

Potable water filter (if installed)

To maintain high hygienic standards, proceed as follows:

- Replace filter element on non-back flushing filters every six months (visual inspection every two months).
- On back flushing filters, back flush every two months.

Damaged cables / lines

If there is damage to the connecting cables or lines of the appliance or externally installed accessories, these must be replaced with Viessmann cables or lines. For this, contact your qualified contractor.



Overview of "Main menu"

Note

Not all of the displays and checks listed may be available under , depending on the features of your system.







Heating















 Heating circuit 1	
	Set room temperatures or Set flow temperature
	Time program, heating
	Only for weather-compensated mode: Heating curve
	Only for weather-compensated mode or continuous operation: Additional heating circuits  , ...
	As for  Heating circuit 1

Test mode

DHW

-  DHW on/off
-  Set DHW temperature
-  Time program, DHW
-  Time program, DHW circulation
-  Hygiene function

Settings

-  Language
-  Display setting
-  Date and time
-  Buzzer
- Only for weather-compensated mode or continuous operation:
-  Rename heating circuits
-  Factory settings
-  Internet
-  Low power radio on/off
-  Clean screen
-  Units
-  Lock panel
-  Change password
-  Selecting the default display
-  Energy cockpit

Overview of "Main menu" (cont.)

Information	
--------------------	--

General	
----------------	--

System pressure
Only for weather-compensated mode: Outside temperature
Flow temperature
Boiler circuit pump
Temperature, low loss header
Flue gas temperature
Burner
Burner hours run
Thermal output
Central fault message
Screed function
Time
Date
Serial number of heat generator VIN
Serial number of electronics module HMU

Heating circuit 1	
--------------------------	--

Operating program
Operating status
Only for weather-compensated mode or continuous operation: Time program
Room temperature
Set reduced room temperature or Reduced
Set normal room temperature or Normal
Only for weather-compensated mode or continuous operation: Set comfort room temperature or Comfort
Only for weather-compensated mode: Heating curve slope
Heating curve level
Heating circuit pump
Flow temperature
Only for weather-compensated mode or continuous operation: Holiday program
Only for weather-compensated mode or continuous operation: Holidays at home

Only for weather-compensated mode or continuous operation: Additional heating circuits 2 , ...	
--	--

As for 1 Heating circuit 1

Overview of "Main menu" (cont.)

 Information	
---	--

 DHW	
---	--

Time program, DHW
Time program, DHW circulation
DHW temperature
DHW circulation pump
Cylinder loading pump

 Burner	
--	--

Burner
Burner hours run
Burner starts
Burner modulation
Flow temperature
Flue gas temperature
Flow sensor

 Contractor contact details	
--	--

 Internet	
---	--

Manufacturer's details
MAC address
Activated
Network
Signal strength
DHCP activated
Ipv4 address
Ipv4 subnet mask
Standard gateway
Primary DNS server
Secondary DNS server
Backend connection
Network connection

 Open source license	
---	--

Overview of "Main menu" (cont.)

Information

Solar energy

Solar energy bar chart
Collector temperature
Solar DHW
Solar circuit pump (operating time)
Solar energy
Solar circuit pump (operating state)
Set DHW temperature for reheating suppression
Solar stagnation
TS3: Temperature, DHW preheating
TS4: Temperature, DHW reheating
Solar circulation pump
TS3: Buffer temperature
TS4: Return temperature, heating circuit
Solar 3-way valve position
Solar central heating backup
TS3: DHW preheating temperature

Only for weather-compensated mode or continuous operation:

Holiday program

Note

This can be selected only if "Apartment building" was selected during commissioning and multiple heating circuits are installed.

Select all

Heating circuit 1

Heating circuit 2

etc.

Only for weather-compensated mode or continuous operation:

Holidays at home

Note

This can be selected only if "Apartment building" was selected during commissioning and multiple heating circuits are installed.

Select all

Heating circuit 1

Heating circuit 2

etc.

Message lists

Service

Terminology

Standby mode

Heat generation is switched off.

Note

Standby mode can be selectively enabled for one or more heating circuits or for DHW heating.

If all heating circuits and DHW heating are shut down: Frost protection is only active for the heat generator and DHW cylinder. No central heating, no DHW heating.

Setback mode (reduced heating mode)

See "Reduced heating mode".

System version

The system version describes the components of your system.

Some examples:

- Heat generator
- Heating circuit pump
- Mixer

- Valves
- Electronics module
- Radiator

Every system is individually configured and adapted to the local conditions by your heating contractor.

Operating program

The operating program enables you to define the following, for example:

- How you heat your rooms
- Whether you heat DHW

Operating status

See "Time program".

Operating mode

See "Heating operation".

Mixer extension kit

Assembly (accessories) for controlling a heating circuit with mixer: See "Mixer".

Screed drying

Your contractor can switch on this function for screed drying, for example in your new build or extension. This means your screed is dried in line with a fixed time program (temperature/time profile) that is appropriate for the building materials used.

Screed drying affects all heating circuits:

- All rooms are heated according to the temperature/time profile.
Your settings for central heating have no effect on the duration of screed drying (max. 32 days).
- No DHW heating

Underfloor heating

Underfloor heating systems are slow, low temperature heating systems that respond only very slowly to short term temperature changes.

Heating with reduced room temperature at night therefore does not result in any significant energy savings.

Heating mode

Operating modes

To heat your home, the heat generator provides heat as specified by the set flow temperature. The operating mode determines whether the flow temperature is specified with a fixed value or whether it is automatically calculated and adjusted subject to several ancillary conditions.

Your contractor can configure the following operating modes during commissioning:

- Weather-compensated operation
- Continuous operation
- Room temperature-dependent operation

Comfort mode

For periods when you are at home during the day, heat your home with the comfort room temperature or the comfort flow temperature, depending on the operating mode. Set the periods (time phases) with the "**Comfort**" temperature level using the time program for central heating.

Continuous operation

In continuous operation the heat generator provides heating water with a constant flow temperature regardless of the outside temperature.

With this operating mode, you can operate several heating circuits via your control unit.

Standard heating mode

For periods when you are at home during the day, heat your home with the normal room temperature or the normal flow temperature, depending on the operating mode. Set the periods (time phases) with the "**Standard**" temperature level using the time program for central heating.

Room temperature-dependent heating operation

In room temperature-dependent operation a room is heated until the set room temperature has been reached. For this, a separate temperature sensor must be installed in the room.

The heating output is controlled independently of the outside temperature.

With this operating mode, you can operate one heating circuit via your control unit. You can input some of the settings for this heating circuit at your room temperature controller.

Reduced heating operation

For periods when you will be absent or during the night, heat your rooms with the reduced room temperature or the reduced flow temperature, depending on the operating mode. Set the periods (time phases) with the "**Reduced**" temperature level using the time program for central heating.

With underfloor heating systems, reduced heating operation only yields limited energy savings (see "Underfloor heating system").

Weather-compensated heating operation

In weather-compensated operation, the flow temperature is controlled according to the outside temperature. More heat is made available at a lower outside temperature than at a higher one.

The outside temperature is captured and transmitted to the control unit by a sensor fitted outside the building.

With this operating mode, you can operate several heating circuits via your control unit. If remote control units are installed in your rooms, you can also adjust the settings at the remote control units.

Heating curve

Heating curves illustrate the relationship between the outside temperature, the set room temperature and the flow temperature. The lower the outside temperature, the higher the flow temperature.

In order to guarantee sufficient heat with minimum energy consumption at any outside temperature, the conditions of your building and system must be taken into consideration. The heating curve is adjusted by your contractor for this purpose.

Terminology (cont.)

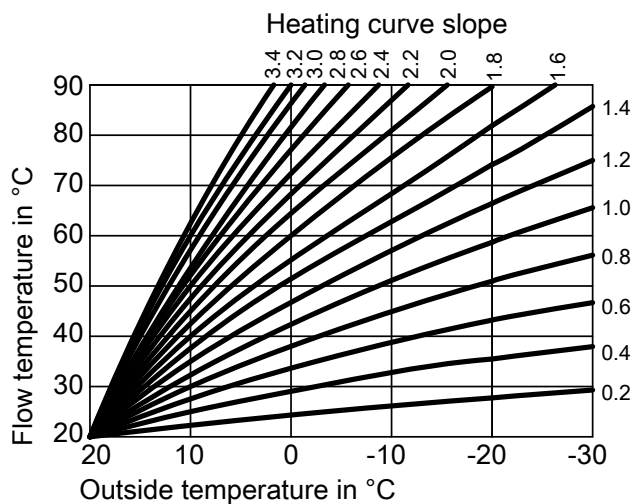

Fig. 16

Setting the slope and level, taking the heating curve as an example

Factory settings:

- Slope = 1.4
- Level = 0

The heating curves shown apply with the following settings:

- Heating curve level = 0
- Standard room temperature (set room temperature) = 20 °C

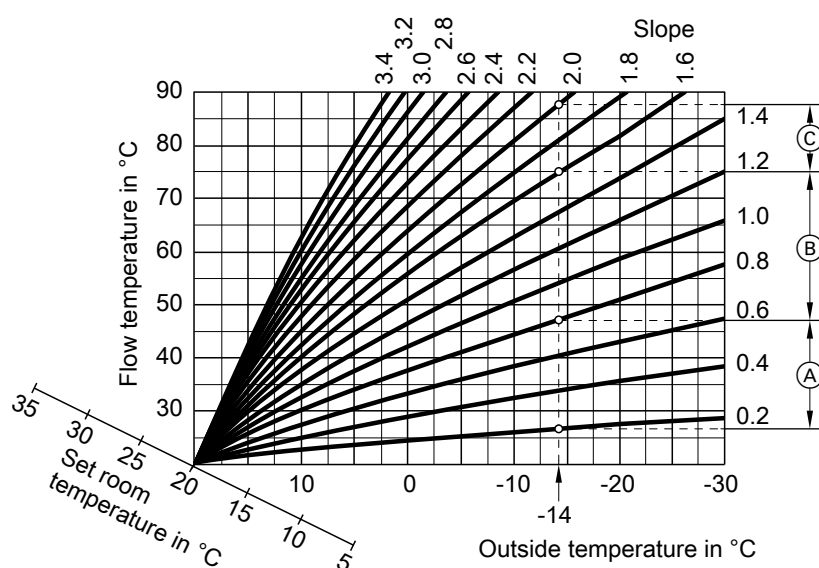
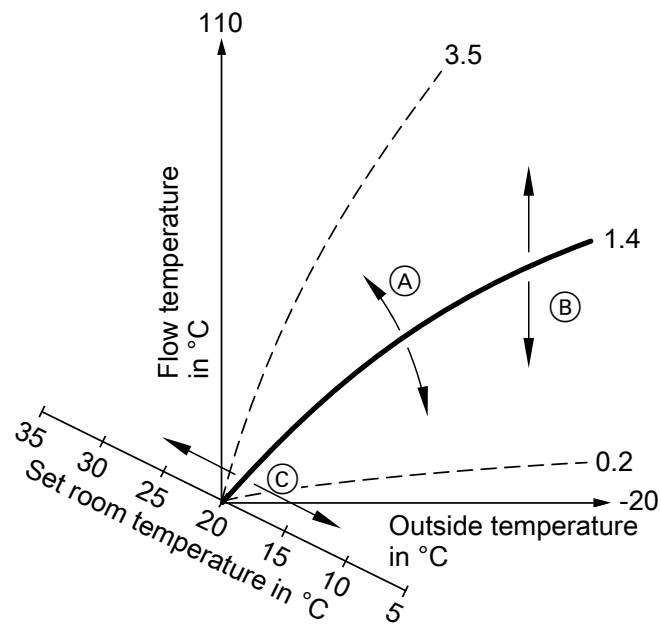

Fig. 17

For an outside temperature of -14 °C :

- (A) Underfloor heating system: Slope 0.2 to 0.8
- (B) Low temperature heating system: Slope 0.8 to 1.6
- (C) System with a flow temperature in excess of 75 °C , slope 1.6 to 2.0

Terminology (cont.)**Note**

Setting the slope or level too high or too low will not cause any damage to your heating system. Both settings affect the level of the flow temperature, which may then be too low or unnecessarily high.

Fig. 18

- Ⓐ If you change the slope:
The steepness of the heating curves changes.
- Ⓑ If you change the level:
The heating curves are shifted in parallel in a vertical direction.
- Ⓒ If you change the standard room temperature (set room temperature):
The heating curves are shifted along the "Set room temperature" axis.

Heating circuit

A heating circuit is a sealed unvented circuit connecting the heat generator and the radiators, in which the heating water circulates.

A system may comprise several heating circuits. For example, one heating circuit for the rooms occupied by you and one heating circuit for the rooms of a separate apartment.

The heating circuits are designated at the factory as "**Heating circuit 1**", "**Heating circuit 2**", etc.

If you or your qualified contractor have renamed the heating circuits, e.g. as "Apartment", that name will be displayed instead of "**Heating circuit...**".

Heating circuit pump

Circulation pump for circulating the heating water in the heating circuit

Mixer

Hot heating water from the heat generator is mixed with cooled heating water from the heating circuit. The heating water, thus brought to the required temperature, is pumped to the heating circuit by the heating circuit pump. To ensure the required set room temperature is achieved, the control unit adjusts the flow temperature via the mixer to suit different conditions.

Terminology (cont.)

Night setback

See "Reduced heating mode"

Open flue operation

The combustion air is drawn from the room where the heat generator is installed.

Room sealed operation

The combustion air is drawn from outside the building.

Room temperature

- Standard room temperature or comfort room temperature:
Set the standard room temperature or comfort room temperature for periods when you are at home during the day.
- Reduced room temperature:
For periods when you will be absent or during the night, set the reduced room temperature; see "Heating mode".

Return temperature

The return temperature is the temperature at which the heating water leaves a system component such as a heating circuit.

Safety valve

Safety equipment that must be installed in the cold water pipe by your contractor. The safety valve opens automatically to prevent excess pressure in the DHW cylinder.

The heating circuits are also equipped with safety valves.

Solar circuit pump

In conjunction with solar thermal systems.

The solar circuit pump delivers the cooled heat transfer medium from the indirect coil of the DHW cylinder to the solar collectors.

Set temperature

See "Set temperature".

Summer mode

In warmer months, you can switch off heating operation.
To do so, select "DHW" operating program "On" and "Standby mode".

The system remains in operation for DHW heating. Central heating is switched off.

Terminology (cont.)

Cylinder primary pump

Circulation pump for heating the DHW in the DHW cylinder.

Set temperature

Specific temperature that should be reached, e.g. set DHW temperature for example.

Drinking water filter

A device that removes solids from the drinking water. The drinking water filter is built into the cold water pipework to the DHW cylinder.

Flow temperature

The flow temperature is the temperature at which the heating water enters a system component such as a heating circuit.

Weather-compensated operation

See "Heating mode"

Time program

In the time programs, you specify what your heating system should do at what time.

For example, the operating statuses for central heating have different temperature levels.

The times for the operating status changeover are defined when the time programs are set.

Operating status

The operating status indicates how a component of your heating system is being operated.

DHW circulation pump

The DHW circulation pump transports the DHW around a loop line between the DHW cylinder and the draw-off points (e.g. hot tap). This ensures that hot water is rapidly available at the draw-off points.

Information on disposal

Disposal of packaging

Your contractor will dispose of the packaging from your Viessmann product.

Information on disposal (cont.)**Final decommissioning and disposal of the heating system**

Viessmann products can be recycled. Components and fluids from your heating system do not belong in ordinary domestic waste.

Please speak to your contractor about the correct disposal of your old system.

Keyword index

A	
Access point mode.....	43
Actual temperature, checking.....	43
Advanced settings.....	38
Ambient temperatures.....	12
B	
Brightness setting.....	37
Burner reset.....	45
C	
Calling up	
– Help messages.....	43
Central heating	
– Factory settings.....	13
– Operating program.....	19
– Switching off.....	28
– Switching on.....	28
– Time phases.....	29
– Time program.....	29
Check	
– Fault message.....	45
– Information.....	43
– Operating statuses.....	43
– Service message (maintenance message).....	44
– Temperatures.....	43
Checking.....	24, 25
– DHW cylinder.....	25
– Heat generator gas consumption.....	24, 25
Cleaning.....	41, 54
Cleaning information.....	54
Cold rooms.....	51
Comfort (tips).....	14
Commissioning.....	12, 49
Contact details of heating contractor.....	39
Contractor.....	39
Controls.....	15
Controls locked out.....	53
Cylinder primary pump.....	64
D	
Date/time, factory setting.....	13
Date setting.....	38
Day temperature (standard flow temperature).....	13
Day temperature (standard room temperature).....	13, 28
Default display	
– Continuous operation.....	23
– DHW.....	23
– Energy cockpit.....	23
– Favourites.....	26
– Heating.....	23
– System overview.....	26
Default display, permanent.....	39
Default setting.....	12
DHW circulation pump.....	64
– Energy saving.....	13
– Time phases.....	35
– Time program.....	35
DHW comfort function	
– Time phases.....	34
– Time program.....	34
DHW heating	
– Comfort.....	14
– Energy saving.....	13
– Factory setting.....	13
– Operating program.....	19, 34
– Outside time program.....	35
– Time phases.....	34
– Time program.....	34
DHW heating, one-off.....	25
DHW hygiene.....	35
DHW temperature	
– Higher.....	35
– Setting.....	34
Display backlight.....	37
Display screen cleaning.....	41
Drinking water filter.....	64
E	
Emissions test mode.....	47
Energy balance.....	24, 26
Energy saving (tips).....	13
Energy saving function	
– Holiday program.....	32
– Long periods of absence.....	32
Extension kit.....	59
External hook-up.....	19
F	
Factory setting.....	12
Factory settings reset.....	42
Fault display.....	53
Fault message	
– Acknowledging.....	45
– Checking.....	45
Favourites.....	26
Favourites compilation.....	26
Filter (drinking water).....	64
Flow temperature.....	28, 64
Flue gas emissions testing.....	47
Frost protection.....	13
Frost protection monitoring.....	13, 48
Further settings.....	38
G	
Glossary.....	59
H	
Heat generator	
– Switching on.....	49
Heat generator, switching on.....	49
Heat generator heating characteristics, changing.....	29
Heating circuit.....	62
Heating circuit naming.....	38
Heating circuit pump.....	62
Heating circuit with mixer.....	59

Keyword index (cont.)

- Heating curve
 – Explanation..... 60
 – Setting..... 29
 Heating mode, reduced..... 13
 Heating mode, standard..... 13
 Heating system
 – Switching off..... 48
 Heating times setting..... 20
 Help message call up..... 43
 Higher DHW temperature..... 35
 Holiday..... 32
 Holiday program
 – Switching off..... 32
 – Switching on..... 32
 Holidays at home..... 14
 – Switching off..... 32
 – Switching on..... 32
 Home screen..... 16
- I**
 Information..... 11
 Information, checking..... 43
 Inspection..... 54
 Installation room..... 12
 Internet access, switching on..... 40
- L**
 Language selection..... 39
 Legal information
 – Communication module..... 43
 – Programming unit..... 43
 Level..... 29
 Level of heating curve..... 60
 Liability..... 9
 Licences..... 12
 – Communication module..... 43
 – Programming unit..... 43
 Lightguide..... 15, 38
 – Meaning..... 15
 Low power radio on/off..... 40
- M**
 Main menu..... 18
 Maintenance..... 54
 Maintenance contract..... 54
 Menu structure..... 55
- N**
 Names for heating circuits..... 38
 Network selection..... 41
 Night setback..... 63
 Night temperature (reduced flow temperature)..... 13
 Night temperature (reduced room temperature)..... 13
 No hot water..... 52
 Notice of completion..... 12
- O**
 ON/OFF switch 49
 One-off DHW heating..... 25
 – Switching off..... 35
 – Switching on..... 35
 Open flue operation..... 63
 Open source licences
 – Communication module..... 43
 – Programming unit..... 43
 Operating mode
 – Explanation..... 59
 Operating program
 – Central heating, DHW..... 19
 – DHW only..... 63
 – Setting, DHW..... 34
 – Special..... 19
 – Terminology..... 59
 Operating status..... 64
 – Explanation..... 59
 Operating statuses, checking..... 43
 Operation, disabling..... 37
- P**
 Power failure..... 13
 Pressure gauge..... 49
 Pressure indicator..... 49
 Product information..... 11
 Pump
 – Cylinder heating..... 64
 – DHW circulation..... 64
 – Heating circuit..... 62
 – Solar circuit..... 63
- R**
 Reduced flow temperature (night temperature)..... 13
 Reduced room temperature (night temperature)..... 13
 Reset..... 42
 Return temperature..... 63
 Room sealed operation..... 63
 Room temperature
 – Adjusting for longer periods at home..... 31
 – Energy saving..... 13
 – For standard heating mode..... 28
- S**
 Safety valve..... 63
 Screed drying..... 19
 Screensaver..... 15
 Service message
 – Display..... 53
 Service message (maintenance message)
 – Checking..... 44
 Setback mode..... 59
 Set temperature..... 63, 64
 Shutdown..... 48
 Shutting down
 – Heating system with frost protection monitoring..... 48
 – System without frost protection monitoring..... 48
 Slope..... 29
 Slope of heating curve..... 60

Keyword index (cont.)

Solar thermal system.....	63	Time phase setting.....	20
Standard flow temperature (day temperature).....	13	Time program.....	13, 64
Standard room temperature (day temperature).....	13	– Central heating.....	29
Standard setting.....	42	– Comfort.....	14
Standby.....	15	– DHW circulation pump.....	35
Standby mode.....	48, 59	– DHW comfort function.....	34
Starting		– DHW heating.....	34
– Frost protection monitoring.....	48	– Energy saving.....	13
– Standby mode.....	48	– Setting.....	19
– System.....	49	Time setting.....	38
Static IP addressing.....	41	Troubleshooting.....	51
Status display.....	15		
Summer/wintertime, setting.....	38	U	
Summer mode.....	59, 63	Underfloor heating.....	60
Summertime changeover.....	13	Units, setting.....	39
System		Utilisation.....	11
– Switching on.....	49		
T		V	
Temperature		ViCare app.....	15
– Checking.....	43		
– Set temperature.....	63, 64	W	
– Standard room temperature.....	28	Water too cold.....	52
Temperatures in the DHW cylinder.....	25	Water too hot.....	53
Terminology.....	59	Weather-compensated operation.....	64
Test mode.....	47	WiFi connection.....	40, 41
Time/date, factory setting.....	13	WiFi network.....	40
Time phase changing.....	21	Winter mode.....	59
Time phase deletion.....	22	Wintertime/summertime changeover.....	13
Time phases		Wintertime changeover.....	13
– Central heating.....	29	Wireless connection to the remote control, switching on.....	40
– DHW circulation pump.....	35		
– DHW comfort function.....	34		
– DHW heating.....	34		

Certification

RoHS
compliant
2011 / 65 / EU

Your contact

Contact your local contractor if you have any questions about your system or wish to arrange maintenance or repair work. You can find local contractors on the internet at www.viessmann.de.



Viessmann Climate Solutions SE
35108 Allendorf / Germany
Telephone: +49 6452 70-0
Fax: +49 6452 70-2780
www.viessmann.com

Viessmann Limited
Hortonwood 30, Telford
Shropshire, TF1 7YP, GB
Telephone: +44 1952 675000
Fax: +44 1952 675040
E-mail: info-uk@viessmann.com