

SPIROTECH SPECIFICATION SHEET



Product: 28 mm Compression fitting

Type:

UA028W

Date:

7/2/2018

Customer:

Project:

Reference:

Design criteria

Medium:	Water / glycol (max 50%)	
Max. flow velocity:	1	m/s
Max. flow rate:	2.00	m ³ /h
Max. pressure:	6	bar-g
Max. temperature:	110	°C
Design standard:	EN 13445	

Testing and quality assurance

Leakage test:	no
Test certificate:	no
Design and manufacturing acc. 2014/68/EU:	yes
Material certificates (structural parts):	no
Drawing:	no

Construction materials

Body:	Brass
Deaeration cap:	Brass
Valve sealing:	Viton
Float:	PP
Spirotube Tube:	Copper
Spirotube Wire:	Copper
Spirotube Solder:	Tin(SnCu3)

Drawing

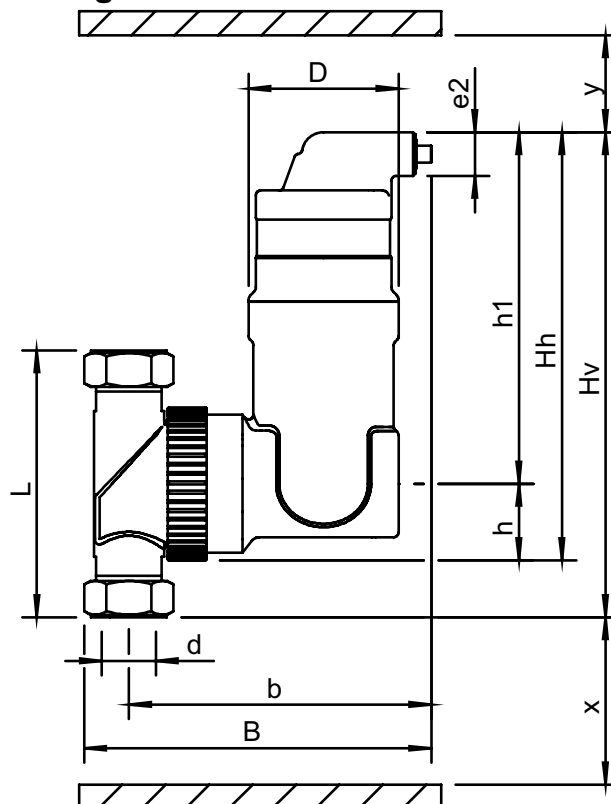

Dimensions

d:	28 mm
h:	32 mm
Hh:	177 mm
Hv:	205 mm
h1:	145 mm
L:	120 mm
D:	62 mm
B:	151 mm
b:	128 mm
x:	>50 mm
y:	>50 mm
e2:	R1/2

Volume 0.18 ltr

Dry weight (approx) 1.8 kg

Subject to changes