

Solar thermal and PV systems



Heating systems ◀

Industrial systems

Refrigeration systems



Energy from the sun – delivered free to your door

Anyone who invests in a new heating system today should also plan to include a solar system at the same time. This will allow you to benefit from lower energy consumption and look forward to receiving lower monthly energy bills.

By installing solar collectors, you are showing your commitment to protecting the environment by reducing CO₂ emissions for the long-term. By choosing Viessmann, you are opting for future-proof technology and a system in which all components interact to optimum effect.

Investing in solar technology also increases the value of your property.

On the following pages, you will find comprehensive information about Viessmann solar technology and the options it provides for energy efficient water heating and space heating.

You know you can count on our high quality and technical expertise thanks to more than 40 years' experience in developing and manufacturing solar thermal systems.

All Viessmann heating systems are designed to work in combination with solar technology, so you can opt for a heat pump, a wood heating system or a new oil or gas condensing boiler as you wish.

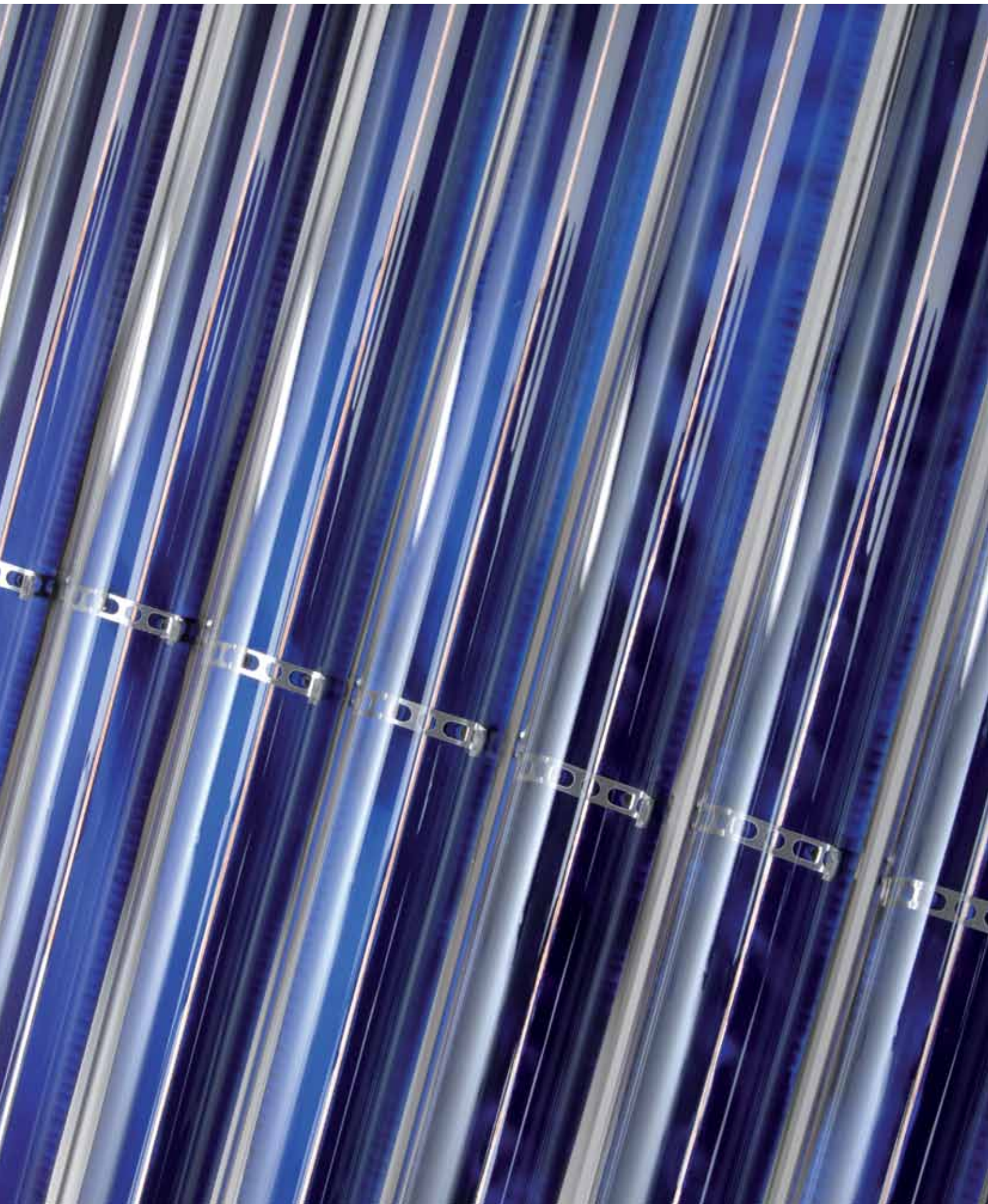

The Viessmann flat-plate and vacuum tube collectors meet every requirement for efficient, cost-effective space heating and water heating. This brochure provides information about our current solar product range. It also contains useful information about our accessories and services.



Solar technology

From page 10

The flat-plate and vacuum tube collectors in the Vitosol series can be optimally matched to energy requirements.

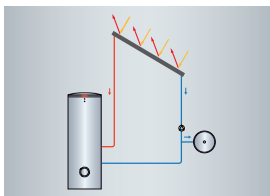

ThermProtect prevents stagnation and overheating

From page 18

For the first time, a flat-plate collector has been developed and patented that prevents further energy absorption once a certain temperature has been reached.



Convenience and cost efficiency by design

From page 28

Use state-of-the-art system technology to control your heating and solar system. The intelligent Vitosolic energy management system communicates highly effectively with the heating control unit, significantly reducing heating bills.



The company

From page 30

The power of innovation: A family business for three generations, Viessmann offers cutting-edge technology and takes its responsibilities seriously.

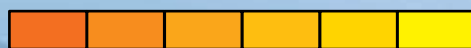
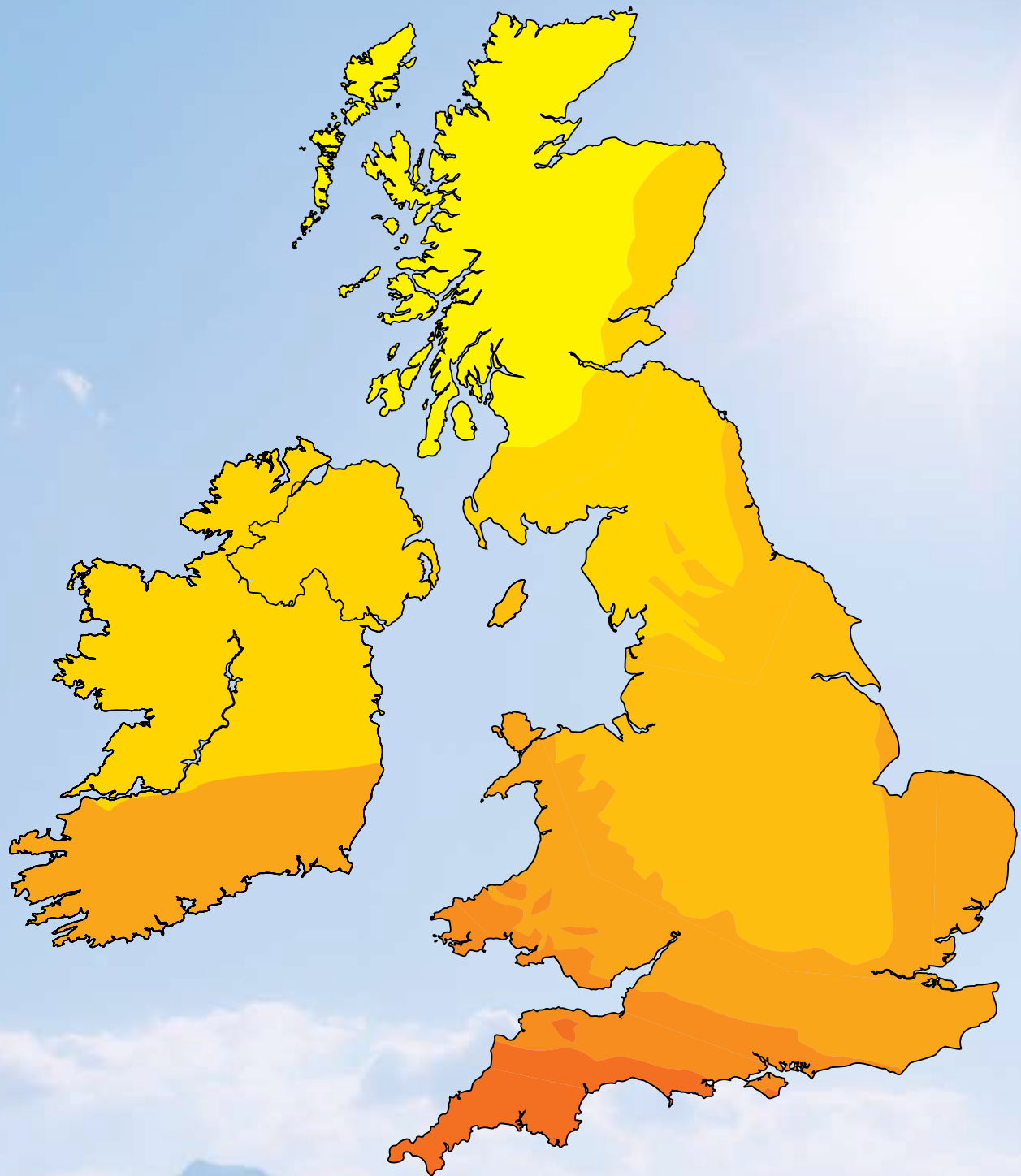

1 200 1 100 1 000 900 800 700
Global radiation kWh/(m²p. a.)

Did you know?

Good reasons for extending your heating system with Viessmann solar heating and photovoltaic.

In a family home, solar energy covers up to 60% of the energy required for heating DHW. In the United Kingdom alone, there are still around 15 million households using outdated heating systems. Their owners are often completely unaware of how much money they are wasting unnecessarily on energy. Furthermore, these old systems have an impact on the climate through unnecessary CO₂ emissions that contribute to global warming.

By promptly replacing these systems with highly efficient condensing boilers in combination with solar technology, end users can cut down on energy usage by up to 35%. This would work out to be 15% of the total UK energy consumption, with annual CO₂ emissions being reduced by 92 million tonnes at the same time.

Heat from the sun

Around one third of the total energy demand in the UK is expended on heating buildings. Energy-conscious construction and economical heating systems, such as condensing technology, can substantially reduce this consumption. This then contributes to the preservation of resources and to the protection of the earth's atmosphere.

One important savings potential is offered by DHW heating. In our latitudes, solar collectors combined with a DHW cylinder represent the most interesting alternative to boiler operation, especially during the summer months. In spring and autumn, you may often be able to turn off your boiler when using solar energy to back up your central heating.

Power from the sun

With a photovoltaic system, you have your own power plant right on the roof of your house. Up to 100% of the total annual power consumption of a four-person household can be produced from it. Thanks to the feed-in tariff in effect since April 2010, money can be earned for every kilowatt hour of energy generated, plus additional money for any energy fed into the grid.

Government subsidies

Government subsidies can be claimed for the purchase of solar and photovoltaic systems provided the products are MCS registered and fitted by an MCS registered installer. After all, the investment costs will pay for themselves after just a few years because of the high energy savings. Up-to-date overviews can be found at www.viessmann.co.uk

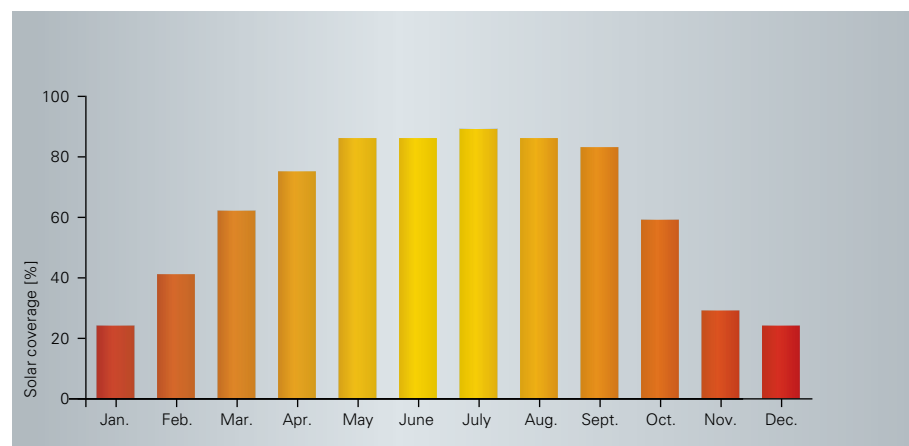

In a family home, solar energy covers up to 60% of the energy required for heating DHW.

Introduction



- 1 Vitodens 200-W wall-mounted gas condensing boiler
- 2 Vitocell 360-M multi-mode combination cylinder for DHW heating and backup heating with attached Solar-Divicon
- 3 Vitosol 200-FM flat-plate collectors

DHW and space heating via solar energy

Solar systems are the perfect choice for DHW heating and space heating. By harnessing freely available solar energy, you can reduce the use of fossil fuels and your investment in solar thermal energy pays for itself in just a few years.

You have the choice of using solar energy for DHW heating and space heating. Savings on oil or gas are considerable in all cases. You will reduce your annual energy consumption by around 60 percent – the energy that you would otherwise need for day-to-day DHW heating. If you combine the heating of DHW and heating water, you will save around 35 percent of the total energy required every year.

Solar system with dual-mode hot water storage cylinder

The dual-mode hot water storage cylinder is the centrepiece of this solution. When there is sufficient insolation, the solar medium in the solar system passes through the heat exchanger to heat up the water in the domestic hot water cylinder.

When the temperature drops when water is used for a bath or shower, for example, the boiler will start to provide additional heating via the second circuit if necessary.

Solar system for DHW heating and backup heating

The solar medium heated up in the solar collectors can also be used to heat domestic hot water and to warm up heating water. To do so, the heating circuit uses the water continuously heated by the solar collectors in the solar cylinder via a heat exchanger. The control checks whether the required room temperature can be achieved. The boiler will switch on as well if the temperature is below the target level.

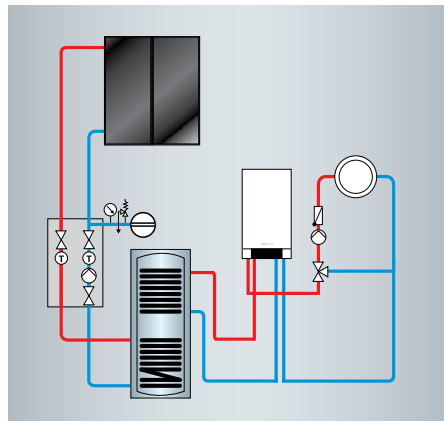

Solar DHW heating

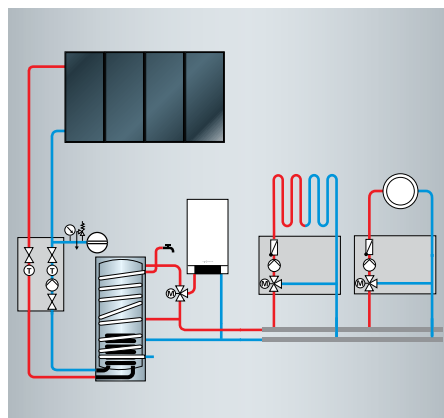

Solar DHW heating and backup heating

Heating and solar technology comes from a single-source provider with Viessmann. All components are perfectly matched to one another.

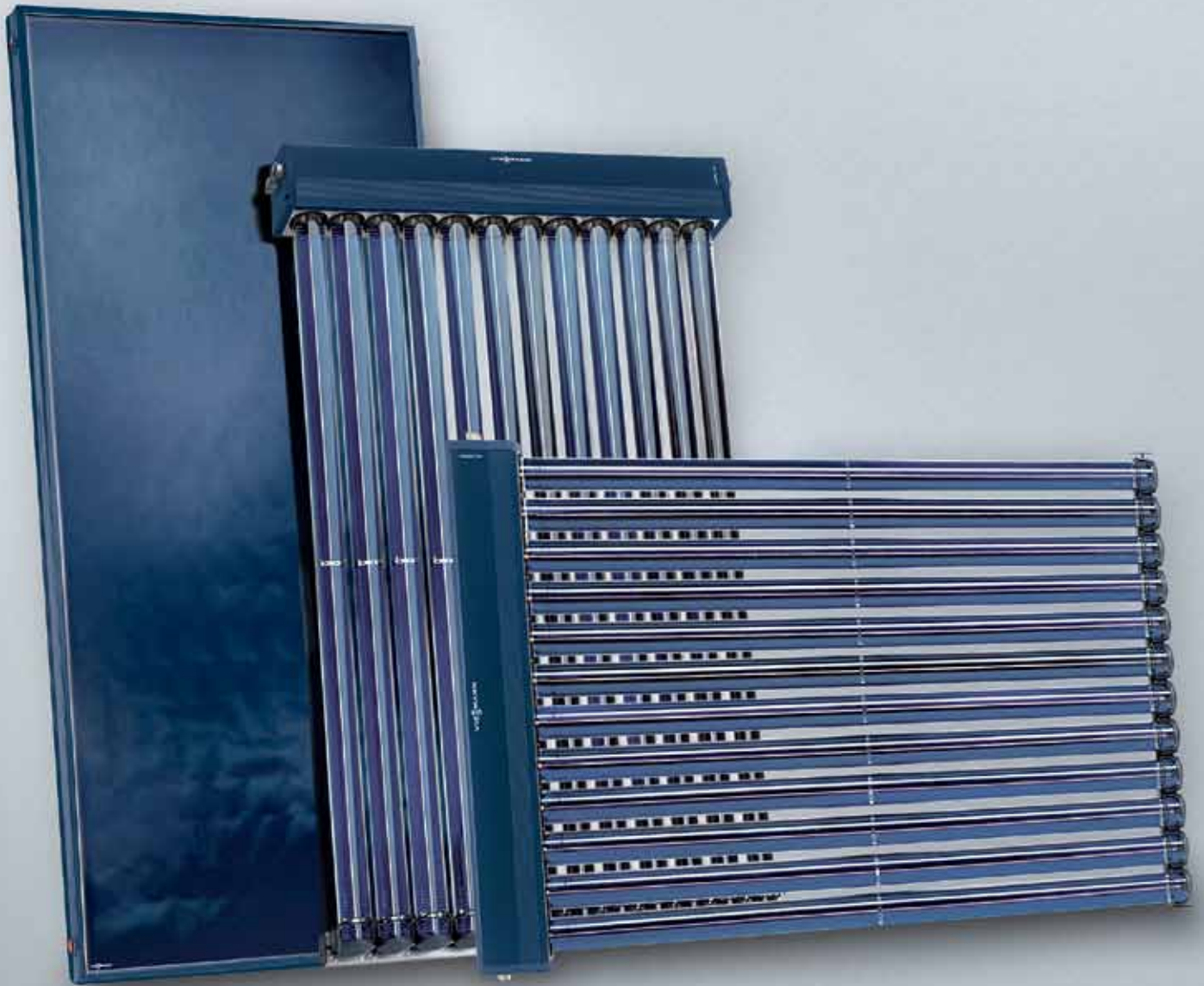

VITOSOL

A wide range of flat-plate and vacuum tube collectors enables Viessmann to supply flexible, customised solutions for all modern heating systems.

On average, the sun emits 1,000 kWh of energy onto every square metre of central Europe every year. This is equivalent to the energy content in 100 litres of fuel oil. With Viessmann solar collectors, you can harness this energy to generate heat. A solar thermal system is the ideal addition to any heating system, reducing energy consumption for the long term.

A heating system that cherishes the environment

When it comes to environmental compatibility, you'll be on the sunny side of the street with Viessmann solar thermal systems: when a detached house uses such a system, it produces, on average, about three quarters of a ton less carbon dioxide (CO₂) per year.

Future-proof in every respect

All Viessmann flat-plate and tube collectors impress thanks to their high operational reliability and long service life. Vitosol solar collectors are made of corrosion- and UV-resistant materials. This is impressively verified by quality testing as per test standard EN 12975 or ISO 9801, which also confirms the consistently high thermal output.

Viessmann can draw on 30 years of experience in developing and manufacturing solar collectors.

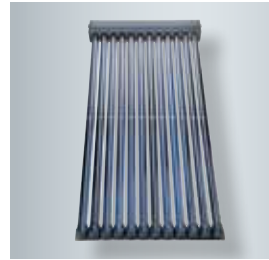

Vitosol 300-T (type SP3B)

Vacuum tube collectors with heat pipe technology and temperature shut-off
Absorber area: 1.51 and 3.03 m²

Page 12

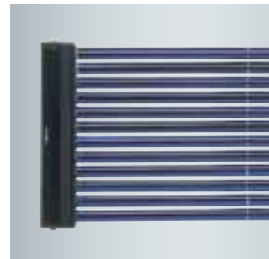

Vitosol 200-T (type SP2A)

Vacuum tube collectors based on the heat pipe principle
Absorber area: 1.26, 1.51 and 3.03 m²

Page 12



Vitosol 200-FM

(type SV2F and SH2F, type SV2G and SH2G)
Flat-plate collectors with ThermProtect
Absorber area: 2.32 m²

Page 20



Vitosol 100-FM

(type SV1F and SH1F)
Flat-plate collectors with ThermProtect
Absorber area: 2.32 m²

Page 20

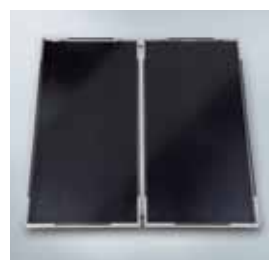

Vitosol 100-FM

(type SVKF and SVKG)
Domestic hot water solar package Vitosol 100-FM flatplate collectors (type SVKF for on-roof installation, type SVKG for roof integration)

Page 27

Solar technology
Tube collectors

Vitosol 300-T
Vitosol 200-T



VITOSOL 300-T VITOSOL 200-T

Highly efficient tube collectors with secure, time-saving plug-in system.

Effective use of solar heat

Absorbers with a highly selective coating capture a vast amount of solar energy, ensuring high efficiency. The vacuum in the tubes also provides highly effective thermal insulation. This means there are almost no energy losses between the glass tubes and the absorber, enabling the collector to convert even low levels of solar radiation into usable energy. The vacuum tube collectors make extremely efficient use of the available insolation, especially in the shoulder months and in the winter when outdoor temperatures are low.

High energy yields for years to come

Viessmann solar collectors are designed for an exceptionally long service life. This is guaranteed by the use of high-grade, corrosion-resistant materials, such as glass, aluminium, copper and stainless steel. The absorber is integrated into the vacuum tube, protecting it from the effects of the weather and contamination and ensuring high energy yields for years to come.

Heat pipe principle for optimum operational reliability

Vitosol 300-T and Vitosol 200-T are high-efficiency vacuum tube collectors based on the heat pipe principle.

In heat pipe systems, the solar medium does not flow directly through the tubes. Instead, a heat transfer medium evaporates in the heat pipe below the absorber and transfers the heat to the solar medium. Reliable operation is assured thanks to the dry heat pipe tube connection inside the header, the small amount of fluid contained in the collector and automatic temperature shut-off in the case of the Vitosol 300-T.

Fast, safe installation

Vitosol tube collectors are delivered in a pre-assembled modular design. The tubes are quickly and easily installed thanks to an innovative plug-in system. The individual tubes can be rotated for optimum alignment with the sun. They are connected in a dry state, i.e. without direct contact between the heat transfer medium and the solar medium, allowing individual tubes to be replaced without draining the system. Each collector is linked to the next by stainless-steel corrugated-pipe plug-in connectors.



The Vitosol 300-T vacuum tube collector won the iF product design award 2014.

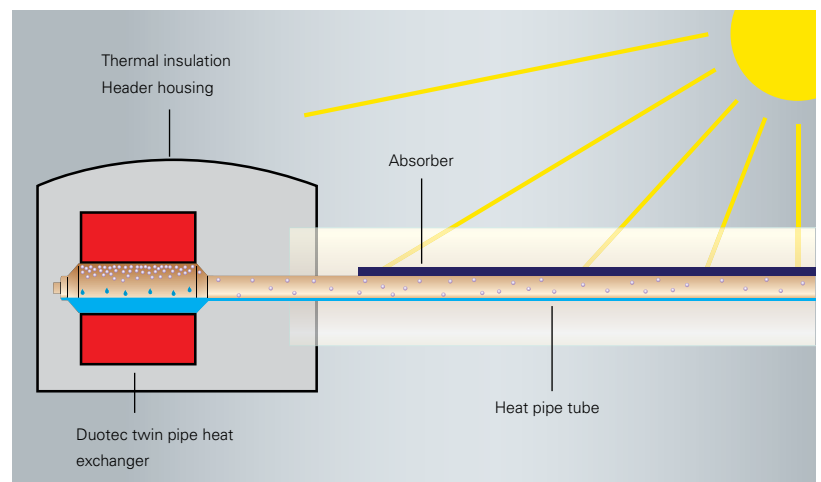

Heated by the sun, the medium evaporates and moves to the colder part of the tubes, where the steam condenses and transfers the heat to the header. The water then re-enters the circuit, where it is heated again.

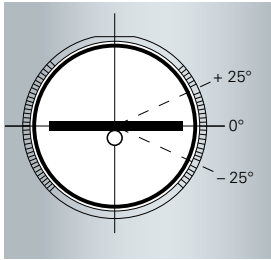

Simple installation and rapid absorber alignment thanks to the angular scale on the tube holders



Rafter hooks ensure easy, secure collector installation

In Vitosol 300-T, Viessmann offers a high performance vacuum tube collector that meets strict requirements for efficiency and safety.

The new Vitosol 300-T (type SP3B) high-performance collector delivers an exceptionally high yield thanks to its anti-reflective coating on both sides of the vacuum tube and on-site absorber alignment by up to +/- 25 degrees. The copper header also plays a role in its high performance. This collector has been designed specifically for highly efficient systems, where space is at a premium.

It impresses thanks to its optimum operational reliability. For example, the automatic temperature shut-off is activated if transfer ceases for a longish period of time when insolation levels are high.

High operational safety thanks to the heat pipe principle

Reliable operation is assured thanks to the dry heat pipe tube connection inside the header, the small amount of fluid contained in the collector and automatic temperature shut-off. The Vitosol 300-T is thus suitable for use in systems with reduced heat transfer over longer periods of time in places such as schools and universities.

In heat pipe systems, the solar medium does not flow directly through the tubes. Instead, a heat transfer medium evaporates inside the heat pipe below the absorber and transfers the heat to the solar medium via the Duotec twin pipe heat exchanger.

Maximum heat transfer with Duotec

To maximise heat transfer, the condensers are completely enclosed in the patented copper Duotec twin pipe heat exchanger. This absorbs the heat and transfers it very effectively to the heat transfer medium as it flows past.

Exceptionally long service life

Vitosol 300-T is designed for an exceptionally long service life, guaranteed thanks to the use of high grade, corrosion-resistant materials, such as glass, aluminium, copper and stainless steel. The absorber is integrated into the vacuum tube, protecting it from the effects of the weather and contamination and ensuring high energy yields for years to come.

Quick and easy installation

The on-roof installation system with rafter hooks or rafter anchors makes it easier to attach the collectors. The new rafter hook is screwed directly onto the rafter, enabling collectors to be fitted perfectly to the roof cover concerned. The mounting rails also save time during installation. Dark blue cover panels between the collector housings produce a uniform overall appearance as they match the absorber areas. Retaining caps in the base rail prevent the tubes from slipping. Should servicing be required, heat pipe tubes can be quickly and easily replaced thanks to their dry connection, even when the system is filled to capacity.

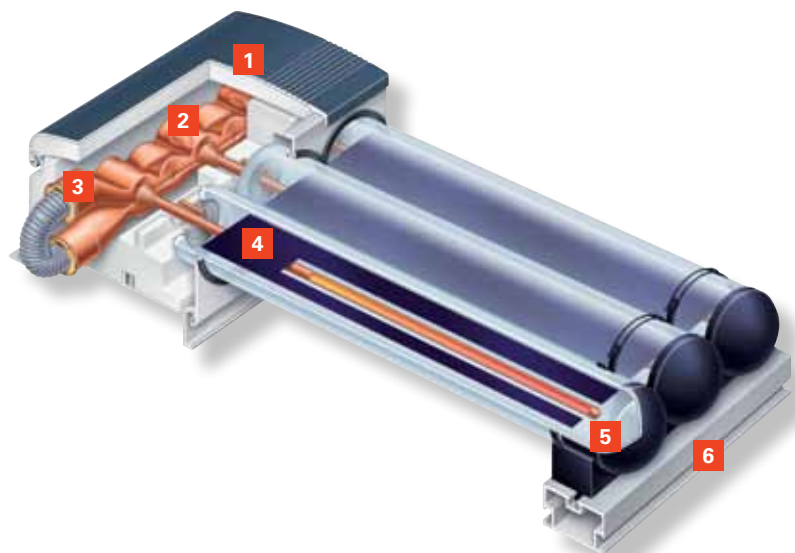

Vitosol 300-T

- 1 Highly effective thermal insulation
- 2 Dry connection – no direct contact between heat transfer medium and solar medium
- 3 Duotec copper twin pipe heat exchanger
- 4 Absorber with highly selective coating
- 5 Heat pipe (heat tube)
- 6 Base rail



Vitosol 300-T offers options for universal use on roofs.

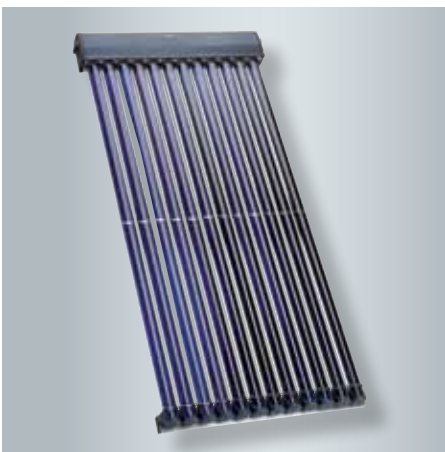

High-performance Vitosol 300-T vacuum tube collector (type SP3B)

Take advantage of these benefits

- Highly efficient vacuum tube collector based on the heat pipe principle with temperature shut-off for the vacuum tubes to ensure high operational safety
- Integrated into the vacuum tube, the absorber areas with highly selective coating are not susceptible to contamination
- Efficient heat transfer through condensers fully encased by the copper twin pipe Duotec heat exchanger
- Rotating tubes ensure optimal absorber alignment with the sun
- Dry connection: no contact between the heat transfer medium and solar medium, i.e. individual tubes can be replaced when the system is filled to capacity
- Dark blue collector housings and absorber areas provide a uniform overall appearance
- Highly effective thermal insulation on the header housings for minimum thermal losses
- Quick, easy installation with the Viessmann assembly and connection systems

See page 26 for technical specifications

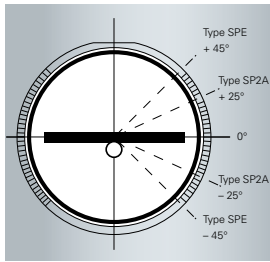

Simple installation and rapid absorber alignment thanks to the angular scale on the tube holders



Rafter hooks ensure easy, secure collector installation

Vitosol 200-T is a highly efficient vacuum tube collector, based on the heat pipe principle.

Vitosol 200-T type SP2A

The Vitosol 200-T (type SP2A) vacuum tube collector offers great flexibility as it can be installed in any position. Suitable for installation on façades, balconies and pitched roofs, it can also be used in large-scale plants for industrial and commercial purposes. It is also an appealing architectural element thanks to its elegant design.

One major advantage of the Vitosol 200-T (type SP2A) is its optional installation on a façade, where the angle of the absorber can be repositioned up to ± 25 degrees to ensure maximum use of solar energy. A special balcony module (1.26 m² absorber area) with a lower installation height is available for use on balcony railings.

Maximum heat transfer

with Duotec and Vitosol 200-T (type SP2A)

To maximise heat transfer, the condensers are completely enclosed in the patented stainless-steel Duotec twin pipe heat exchanger. This absorbs the heat and transfers it very effectively to the heat transfer medium as it flows past.

Easily and quickly installed

The on-roof installation system with rafter hooks or rafter anchors makes it easier to attach the Vitosol 200-T (type SP2A).

Contractors save time during installation of both Vitosol 200-T models as only two rails are required. The header housing does not need to be opened to insert the tubes. New retaining caps in the base rail prevent the tubes from slipping while they are being inserted.

Should servicing be required, the pipes can be replaced quickly and easily thanks to their dry connection, even when the system is filled to capacity.

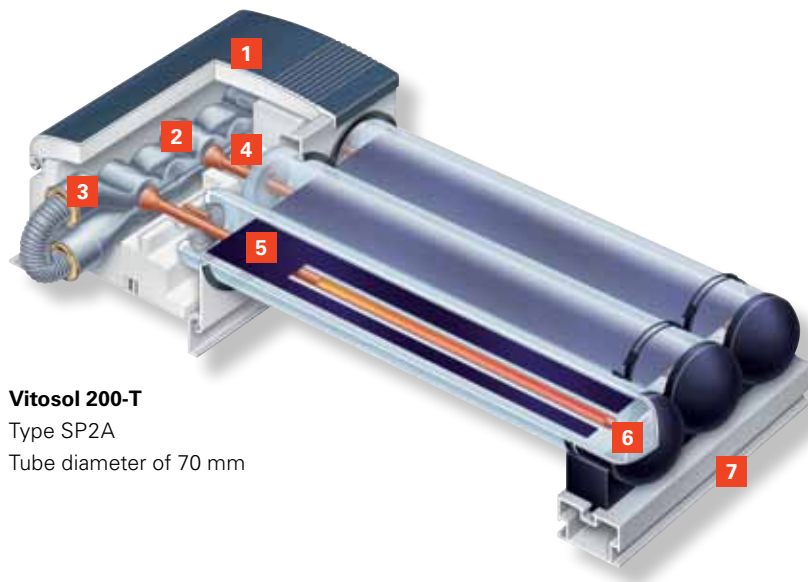

Vitosol 200-T

- 1 Highly effective thermal insulation
- 2 Dry connection: no direct contact between heat transfer medium and solar medium
- 3 Duotec twin pipe heat exchanger
- 4 Tubes are easy to replace and rotate
- 5 Absorber with highly selective coating
- 6 Heat pipe
- 7 Base rail

Vitosol 200-T

Type SP2A

Tube diameter of 70 mm



Example of use for Vitosol 200-T tube collectors

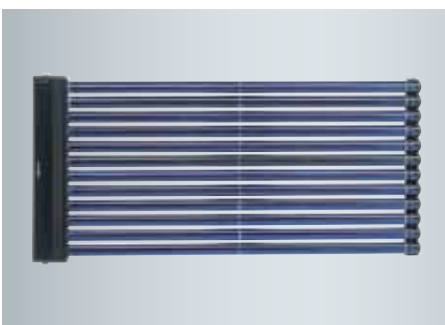

Vitosol 200-T
Type SP2A

Take advantage of these benefits

Vitosol 200-T, type SP2A

- Vacuum tube collectors based on the heat pipe principle for optimum operational reliability
- Dry connection, no contact between the heat transfer medium and the solar medium, i.e. individual tubes can be replaced when the system is filled to capacity
- Less floor space required than for flat-plate collectors
- Consistently high performance without risk of contamination
- Aluminium collector housing

Vitosol 200-T, type SP2A

- All-purpose vacuum tube collector
- Appealing architectural element when mounted on balconies and façades
- Retaining caps in the base rail to prevent tubes from slipping
- Simple installation and rapid absorber alignment thanks to the angular scale on the tube holders

See page 26 for technical specifications

Solar technology
Tube collectors

ThermProtect

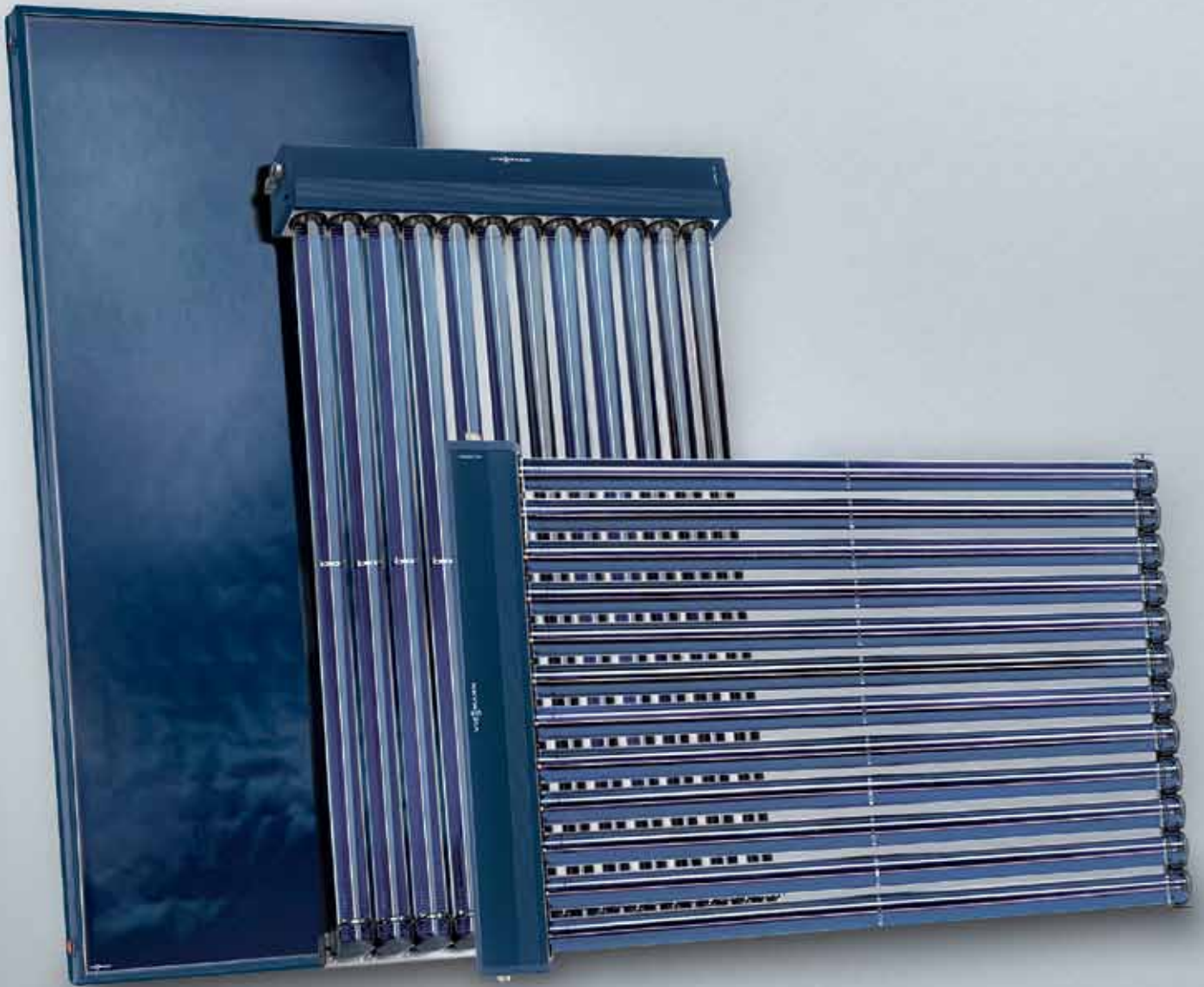

THERMPROTECT

Prevent stagnation and overheating with our innovative absorber coating

For the first time, a flat-plate collector has been developed and patented that prevents further energy absorption once a certain temperature has been reached.

ThermProtect prevents overheating

An intelligent absorber coating protects the collectors against overheating. Patented by Viessmann, the ThermProtect technology switches off further energy intake when a specific temperature is reached if the solar cylinder is fully heated up. The absorber coating's crystal structure changes state above the switching temperature, increasing heat emission greatly and reducing the collector output. This means the stagnation temperature is significantly lower, preventing steam from forming.

As the collector temperature decreases, the crystal structure reverts to its original state. More than 95 percent of the incoming solar energy can now be absorbed and converted into heat again. Only the remaining five percent is reflected. The change in the crystal structure is reversible at any time and the function is permanently available.

ThermProtect also produces a higher yield in Vitosol 200-FM and Vitosol 100-FM compared to conventional flat-plate collectors since the collectors can be put back into operation more readily when needed.

Standard absorber

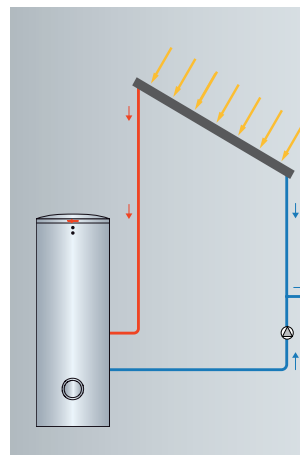

ThermProtect switching absorber

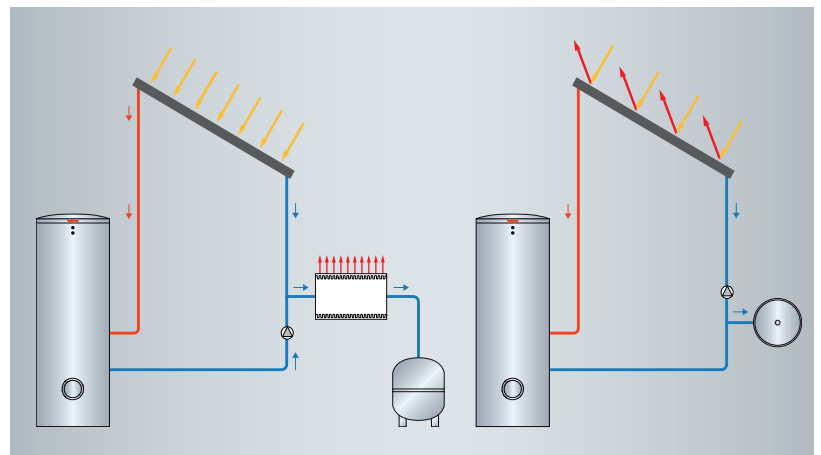

In systems with ThermProtect temperature-dependent shutdown, the formation of steam is reliably prevented.

Reliable prevention of steam formation

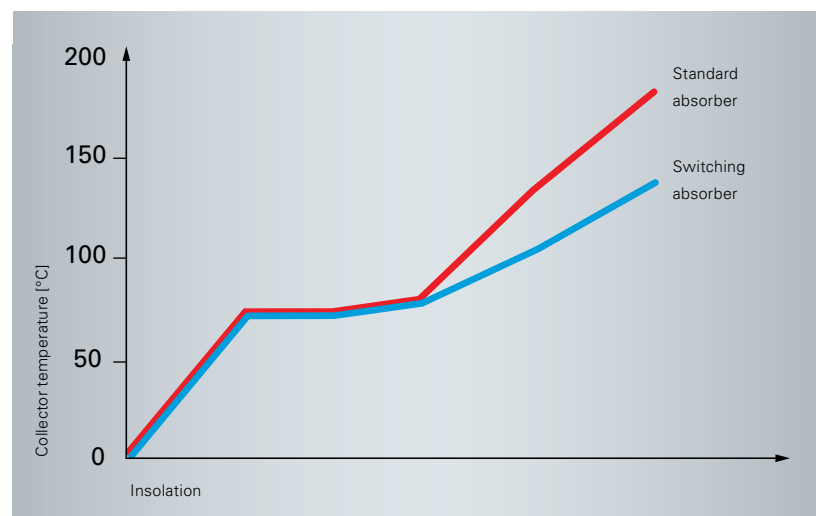

In standard collector mode, the new absorber coating of the Vitosol 200-FM flat-plate collector acts like any standard absorber coating on Viessmann flat-plate collectors. At collector temperatures of 75 °C and above, heat transfer increases many times over, thus reliably preventing overheating and the formation of steam in the event of stagnation.

Solar technology
Flat-plate collectors

Vitosol 200-FM
Vitosol 100-FM



VITOSOL 200-FM

VITOSOL 100-FM

Patented by Viessmann, the switching absorber coating protects high-performance flat-plate collectors against overheating and stagnation.

The high-performance flat-plate collectors Vitosol 200-FM and Vitosol 100-FM are an ideal addition to any heating system. With an absorber area of 2.3 m², these solar collectors adapt to specific energy requirements. On average, they replace up to 60 percent of the energy required to heat domestic hot water every year while also helping to provide backup heating. When combined with a condensing boiler, users can even cut their annual energy consumption for heating and hot water by more than a third.

Straightforward system engineering

The temperature-dependent shutdown of these two collectors is entirely independent of system configuration and control unit settings. Solar thermal systems are, therefore, completely fail-safe. The thermal loads on system components and the heat transfer medium always stay within their normal range. This increases service life and operational reliability compared to conventional solar thermal systems. In addition to robust operation, collectors with temperature-dependent shutdown are also more tolerant of incorrect sizing.

Benefits for trade partners:

- High operational reliability and long service life thanks to lower stagnation temperatures
- Independent of controller settings, power failures and mechanical devices (e.g. dampers)
- Significantly lower stress on system components
- Can easily be sized for large plants
- Immediate restart after system standstill
- Simplified component selection (e.g. smaller expansion vessels)

Benefits for the user:

- No overheating problems in summer or when residents are away from home
- Higher solar coverage for central heating backup and DHW heating



Vitosol 200-FM
Semi-detached house, Geisenfeld



Collector frame with special roof integration profile for fitting the covering frame

Add appeal to any roof

Vitosol 200-FM is the right choice when the collector is to be supplied with a frame in a custom RAL colour. Finished in dark blue as standard, the frame subtly blends into most roofs. Vitosol 100-FM is only available with an aluminium-colour frame.

Vitosol 200-FM type SV2G (vertical) or type SH2G (horizontal) can be fitted almost flush with the roofing to ensure it is harmoniously integrated into the roof.

The Vitosol 200-F large-surface collector (type 5DIA) with its 4.87 m² absorber area provides an alternative to individual collectors.

Permanently sealed and well insulated

The surrounding folded aluminium frame and seamless pane mount ensure permanent leak-tightness and a highly stable collector. The rear panel is puncture-proof and corrosion-resistant. Highly effective thermal insulation reduces heat losses, especially in winter and the shoulder months.

Easy installation

Both collectors are exceptionally installation-friendly. Integrated flow and return pipes ensure secure installation even for larger collector arrays thanks to the flexible stainless-steel corrugated-pipe plug-in connectors. Up to twelve solar collectors can be easily linked together.

The flat-plate collectors are universally suitable for on-roof installation, roof integration and freestanding installation in locations such as flat roofs. The easy-to-install Viessmann fixing system comprises structurally tested, corrosion-resistant components made of stainless steel and aluminium.

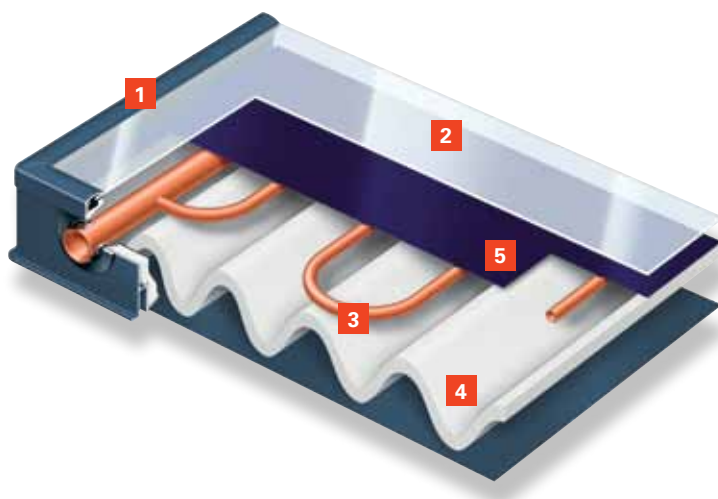

Vitosol 200-FM

- 1 Surrounding folded aluminium frame with glazing bead
- 2 Sturdy, highly transparent cover made from special glass with ThermProtect
- 3 Meander-shaped absorber
- 4 Highly effective thermal insulation
- 5 Absorber panel featuring ThermProtect coating with automatic temperature shut-off



With optional edge trim in all RAL colours, Vitosol solar collectors blend harmoniously into most roofs.

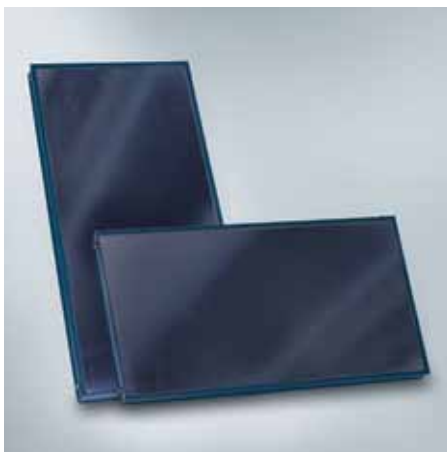

Vitosol 200-FM with switching absorber coating ThermProtect

Take advantage of these benefits

- High-performance Vitosol 200-FM and Vitosol 100-FM flat-plate collectors with switching absorber coating ThermProtect
- No overheating at high outdoor temperatures or low heat transfer
- Increased solar coverage for backup heating and DHW heating
- Permanently sealed thanks to surrounding collector frame and seamless pane mount
- Quick, secure attachment with flexible stainless-steel corrugated-pipe plug-in connectors
- Universally suitable for on-roof, flat roof, in-roof and façade installation
- Horizontal and vertical installation possible
- Appealing design, custom RAL coating on the frame (Vitosol 200-FM)

See pages 26 and 27 for technical specifications

Photovoltaic
modules

Vitovolt 300



VITOVOLT 300

Patented by Viessmann, the switching absorber coating protects high-performance flat-plate collectors against overheating and stagnation.

The right model for every house

The right photovoltaic module for any requirement: The Vitovolt 300 product range offers monocrystalline modules up to an output rating of 270 Wp. The range also includes 48 or 60 cell polycrystalline modules that have an output of up to 260 Wp.

High yielding photovoltaic modules; quality without compromise

Vitovolt 300 photovoltaic modules are distinguished by their high output, uncompromising quality and extensive product and performance guarantees. In addition, all modules offer only 'plus' output tolerances as standard. You benefit from an increase in output of up to 5 Wp as a result. Our photovoltaic modules are suitable for installation on the roofs of detached houses and apartment buildings, as well as on commercial and industrial premises.

Attractive design

Vitovolt 300 modules are distinguished by their design and dimensions. Modules in the MSBC series feature a black anodised frame, monocrystalline cells in a particularly dark hue and a black Tedlar film. Extraordinary performance values! The effect is even more architecturally stunning when these modules are incorporated into a flush mounted roof integration system.



Take advantage of these benefits

- Positive output tolerance for additional output of up to 5 Wp per module
- Anti-reflection glass for high yields
- Security of investment resulting from product guarantee extended to 10 years and a 25-year output guarantee to at least 80 % of rated output
- High module efficiency of up to 16.8 %
- Non-twisting anodised aluminium frame
- Strict cell selection process for balanced and high value appearance
- High operational reliability as a result of three bypass diode jumpers
- Tested Viessmann quality: Every photovoltaic module is subjected to an optical and electrical quality test
- Standardised process for the ability to recycle all Vitovolt 300 modules in a sustainable and efficient manner

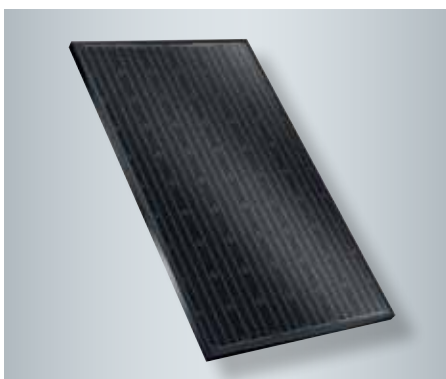

Monocrystalline photovoltaic module Vitovolt 300 with black anodised frame and dark Tedlar film



Polycrystalline photovoltaic module Vitovolt 300 with 48 or 60 cells in a compact design



Vitosol 300-T vacuum tube collector

		Vitosol 300-T (type SP3B)	Vitosol 300-T (type SP3B)
Absorber area	m ²	1.51	3.03
Gross area	m ²	2.36	4.62
Aperture surface	m ²	1.60	3.19
Dimensions			
Length (depth)	mm	150	150
Width	mm	1053	2061
Height	mm	2241	2241
Weight	kg	40	79



Vitosol 200-T vacuum tube collector

		Vitosol 200-T (type SP2A)	Vitosol 200-T (type SP2A)
Absorber area	m ²	1.51	3.03
Gross area	m ²	2.36	4.62
Aperture surface	m ²	1.60	3.19
Dimensions			
Length (depth)	mm	150	150
Width	mm	1053	2061
Height	mm	2241	2241
Weight	kg	39	79

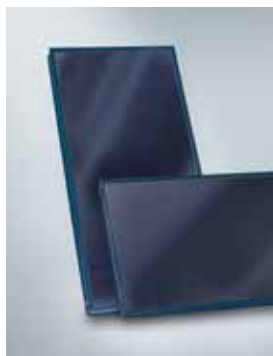

Vitosol 200-FM flat-plate collectors

		Vitosol 200-FM (type SV2F)	Vitosol 200-FM (type SH2F)	Vitosol 200-FM (type SV2G)	Vitosol 200-FM (type SH2G)
Gross area	m ²	2.51	2.51	2.56	2.56
Absorber area	m ²	2.32	2.32	2.32	2.32
Aperture surface	m ²	2.33	2.33	2.33	2.33
Dimensions					
Width	mm	1056	2380	1070	2394
Height	mm	2380	1056	2394	1070
Depth	mm	90	90	90	90
Weight	kg	41	41	41	41



Vitosol 100-FM flat-plate collectors

		Vitosol 100-FM (type SV1F)	Vitosol 100-FM (type SH1F)
Gross area	m ²	2.51	2.51
Absorber area	m ²	2.32	2.32
Aperture surface	m ²	2.33	2.33
Dimensions			
Width	mm	1056	2380
Height	mm	2380	1056
Depth	mm	72	72
Weight	kg	42	42



Vitosol 100-FM flat-plate collectors

Vitosol 100-FM individual collector	Type	SVKF	SVKG
Absorber area	m ²	2.01	2.01
Gross area	m ²	2.18	2.23
Aperture surface	m ²	2.02	2.02
Dimensions			
Width	mm	1056	1070
Height	mm	2066	2080
Depth	mm	73	73
Weight	kg	37	38

Vitosol 100-FM (type SVKF) for on-roof installation

Vitosol 200-F (type SVKG) for in-roof installation



Vitovolt 300 photovoltaic modules

		Vitovolt 300 M260 MSBC M265 MSBC M270 MSBC	Vitovolt 300 P200 PSEA	Vitovolt 300 P250 PSEB P255 PSEB P260 PSEB	Vitovolt 300 P250 PGHA P255 PGHA
Output category	W _p	260 - 270	200	250 - 260	250 - 255
Module efficiency	%	up to 16.8	15.19	up to 15.97	up to 15.6
Type of cell		Monocrystalline	Polycrystalline	Polycrystalline	Polycrystalline
Dimensions					
Width	mm	983	986	989	990
Height	mm	1639	1335	1654	1650
Depth	mm	40	46	40	42



The Viessmann Vitocell range offers the right hot water storage cylinder for every requirement, ideally matched to your heat generator.

Convenience and cost efficiency by design

Viessmann supplies you with all the technology you need from a single source.

Viessmann offers optimally matching system technology from a single source to ensure a complete solar thermal range. All components are optimally matched. This gives you the guarantee of optimum efficiency and high operational reliability for your heating and solar system.

Viessmann's all-inclusive range includes solar collectors, specially developed combination hot water storage cylinders for use with solar energy systems, solar controls, the

Solar-Divicon pump station for safe hydraulic operation and thermal protection of solar systems, oil and gas condensing boilers, wood boilers and heat pumps.

Correctly sized solar systems with matching system components cover up to 60 percent of the annual energy requirements for DHW heating in detached and semi-detached houses, or up to 35 percent of the total requirement for DHW and central heating in low-energy houses.

Hot water storage cylinders

The Vitocell range consisting of dual-mode hot water cylinders, combination cylinders and heating water buffer cylinders provides the right hot water storage cylinder for every need and is ideally matched to the solar energy system concerned.



Solar controls

Vitosolic solar controls ensure highly effective use of solar energy. The intelligent energy management system covers all standard uses and can control up to four separate loads. By communicating with the Vitotronic boiler control unit, the Vitosolic ensures that optimum use is made of the heat obtained from the solar collectors while as little additional energy as possible is used for DHW or central heating.



Solar-Divicon

The solar pump assembly impresses with its elegant, compact design. The thermal insulation encases all components, reducing heat losses to a minimum.



Maximum user convenience with Vitotrol app and smartphone

Controlling Viessmann heating systems couldn't be easier with the Vitotrol app and a smartphone. Convenient, intuitive operation over the Internet is possible from anywhere and at any time. The Vitotrol app is available for mobile terminal devices with iOS or Android operating systems.

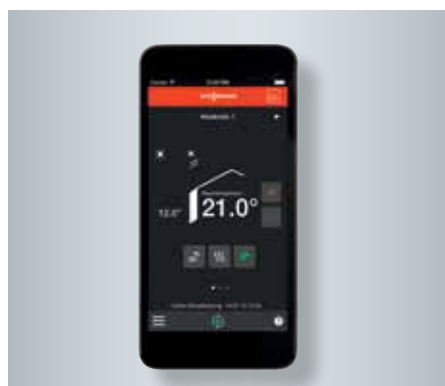

The company

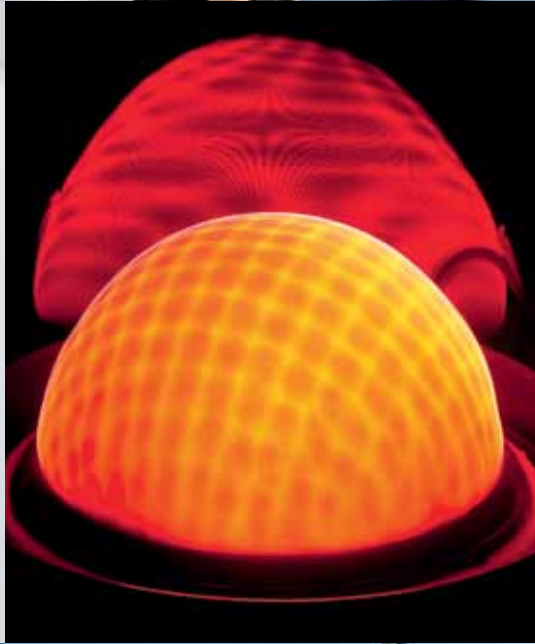

Viessmann – climate of innovation

Viessmann is one of the world's leading manufacturers of intelligent, convenient and efficient systems for heating, cooling and decentralised power generation.

As a third generation family run business, Viessmann has been supplying highly efficient and clean heating systems for many decades.

A strong brand creates trust

Together with our brand label, our key brand message is an identifying feature throughout the world. "Climate of innovation" is a promise on three levels: It is a commitment to a culture of innovation. It is also a promise of enhanced product benefits and, at the same time, an obligation to protect the environment.

Acting in a sustainable manner

For Viessmann, taking responsibility signifies a commitment to acting sustainably.

This means harmonising ecology, economic concerns and social responsibility so that the needs of today are met without compromising the quality of life of future generations.

We consider climate protection, environmental responsibility and resource efficiency to be key priorities throughout our company, which has more than 11,600 employees worldwide.

Example of Best Practice

With its strategic sustainability project, Viessmann demonstrates at its own head office in Allendorf (Eder) that the energy and climate policy goals set for 2050 can in fact be achieved today with commercially available technology. The results speak for themselves:

- Expansion of renewables to 60 percent
- CO₂ emissions reduced by 80 percent

The long term goal is for the company to meet all its own heating energy requirements by sustainable means.



2009/2011/2013:
German Sustainability Award for Production/Brand/Resource Efficiency



Energy Efficiency Award 2010

Viessmann Group

Company details

- Established in: 1917
- Employees: 11,600
- Group turnover: 2.2 billion euros
- Export share: 56 percent
- 22 production companies in 11 countries
- 74 countries with sales companies and branches
- 120 sales offices worldwide

The comprehensive product range from the Viessmann Group for all energy sources and output ranges

- Boilers for oil or gas
- Combined heat and power generation
- Hybrid appliances
- Heat pumps
- Wood combustion technology
- Biogas production plants
- Biogas upgrading plants
- Solar thermal
- Photovoltaics
- Accessories
- Refrigeration systems



climate of innovation

Viessmann Limited
Hortonwood 30, Telford
Shropshire, TF1 7YP
Tel: 01952 675000
Fax: 01952 675040
www.viessmann.co.uk

Your trade partner:

9449 592 - 6 GB 06/2016

Copyright Viessmann
Duplication and alternative use only with prior written consent.
Subject to technical modifications.