

Operating instructions for the system user

VIESMANN

Heat pump control unit with 7" touch display

VITOCAL 150-A **VITOCAL 151-A**



For your safety

 Please follow these safety instructions closely to prevent accidents and material losses.

Safety instructions explained

 **Danger**
This symbol warns against the risk of injury.

 **Please note**
This symbol warns against the risk of material losses and environmental pollution.

Note
Details identified by the word "Note" contain additional information.

The outdoor unit contains easily flammable refrigerant in safety group A3 according to ISO 817 and ANSI/ASHRAE Standard 34.

Target group

These operating instructions are intended for system users.
This appliance can also be operated by children aged 8 and older, as well as by individuals with reduced physical, sensory or mental faculties or those lacking in experience and knowledge, provided such individuals are supervised or have been instructed in the safe use of this appliance as well as in any risks arising from it.

 **Please note**
Supervise children in the proximity of the appliance.

- Never permit children to play with the appliance.
- Cleaning and user maintenance must never be carried out by unsupervised children.

Safety instructions for working on the system

The outdoor unit contains flammable refrigerant R290 (propane C₃H₈). If there is a leak, the escaping refrigerant may form a flammable or explosive atmosphere in the ambient air. A safety zone is defined in the immediate vicinity of the outdoor unit, in which special rules apply.
Illustration of the safety zone: See chapter "Safety zone".

Standing and working in the safety zone

 **Danger**
Risk of explosion: Escaping refrigerant may form a flammable or explosive atmosphere in the ambient air.
Take the following measures to prevent fire and explosion in the safety zone:

For your safety (cont.)

- Keep ignition sources away, e.g. naked flames, hot surfaces, electrical devices not free of ignition sources, mobile devices with integrated batteries (e.g. mobile phones, fitness watches, etc.).
- Do not use flammable materials, e.g. sprays or other flammable gases.
- Do not remove, block or bridge safety equipment.
- Do not make any alterations to the outdoor unit:
 - Do not change, load or damage inlet/outlet lines and electrical connections/cables.
 - Do not change the surroundings.
 - Do not remove any components or seals.
- Do not remove casings.
- Do not modify or remove attachments or fitted accessories.
- Do not open or tighten pipe connections.
- Work on the refrigerant circuit of the outdoor unit may only be carried out by authorised heating contractors. These heating contractors must be trained in accordance with EN 378 Part 4 or IEC 60335-2-40, Section HH. The certificate of competence from an industry accredited body.

**Danger**

Hot surfaces can cause burns.

- Do not open the appliance.
- Do not touch the hot surfaces of uninsulated pipes and fittings.

Connection of the system

- The appliances may be connected and commissioned only by authorised contractors.
- Observe the specified electrical connection requirements.
- Modifications to the existing installation may only be carried out by authorised specialists.

**Danger**

Incorrectly executed work on the system can lead to life threatening accidents.

Work on electrical equipment may only be carried out by a qualified electrician.

Auxiliary components, spare and wearing parts**Please note**

Components that were not tested with the system may cause system damage, or may affect its functions. Have all installation or replacement work carried out exclusively by heating contractors.

Working on the system

- All adjustments and work on the system must be performed as specified in these operating instructions. Other work on the system may only be carried out by authorised contractors, e.g. maintenance, service and repairs.
- Do not open the appliances.

Safety instructions for operating the system

Protect the system against third party influence, damage and environmental influences.

What to do if refrigerant escapes from the outdoor unit

A low pressure fault may indicate escaping refrigerant.



Danger

Escaping refrigerant can lead to fire and explosions that result in very serious injuries or death. There is a risk of asphyxiation if it is breathed in.

If there is a suspicion of escaping refrigerant, note the following:

- Ensure very good ventilation especially in the floor area of the outdoor unit.
- No smoking! Prevent naked flames and sparks. Never switch lights or electrical appliances on or off.
- Initiate rescue measures for individuals.
- Inform the authorised contractor.
- From a safe position, switch off the electricity supply for all system components.



Danger

Direct contact with liquid and gaseous refrigerant can cause serious damage to health, e.g. frostbite and/or burns. There is a risk of asphyxiation if it is breathed in.

- Prevent direct contact with liquid and gaseous refrigerant.
- Never breathe in refrigerant vapours.
- Initiate rescue measures for individuals.

If there is a fire



Danger

Fire presents a risk of burns and explosion.

- From a safe position, switch off the electricity supply for all system components.
- Notify fire service.
- Initiate rescue measures for individuals.
- Only attempt to extinguish the fire if this poses no risk of injury. Use a tested fire extinguisher, class ABC.

What to do if the outdoor unit ices up



Please note

A build-up of ice in the condensate pan and in the fan area of the outdoor unit can cause damage to the equipment.

- In case of ice formation, notify heating contractor.
- Do not use mechanical items/aids for the removal of ice.
- If ice regularly builds up on the outdoor unit (e.g. in areas where frost and heavy fog occur frequently), have a contractor install fan ring heating (accessories) that is suitable for refrigerant R290 and/or an electric ribbon heater in the condensate pan (accessories or factory-fitted).

For your safety (cont.)**Conditions for positioning the indoor unit****Danger**





Easily flammable liquids and materials (e.g. naphtha/petrol, solvents, cleaning agents, paints or paper) can cause deflagration and fire. Never store or use such materials in the boiler room or in direct proximity to the indoor unit.

**Please note**

Incorrect ambient conditions can result in system damage and can put safe operation at risk. Maintain the permissible ambient temperatures as detailed in these operating instructions.

1. Safety and liability	Safety zone	9
	Liability	10
2. Introductory information	Symbols	11
	Intended use	11
	Product information	12
	■ Type plate	12
	■ Heat pump control unit	12
	■ Permissible ambient temperatures in the installation room	13
	■ Outside temperature limits	13
	■ Safety zone	13
	Service link	13
	Low power radio	13
	Licence information	13
	Commissioning	14
	Your system is preset at the factory	14
	Energy saving tips	14
	Tips for greater comfort	15
	Quieter operation	15
3. Operation	Operating principles	16
	■ Touchscreen	16
	■ Status display with Lightguide	16
	Screen displays	16
	■ Standby display	16
	■ Default displays	16
	■ Home screen	16
	Buttons and symbols	17
	■ Buttons and symbols in menu bar (A)	17
	■ Buttons and symbols in function area (B)	17
	■ Buttons and symbols in navigation area (C)	18
	Overview of the "Main menu"	18
	■ Menus available in the "Main menu"	18
	Operating program	19
	■ Operating programs for room heating, room cooling and DHW heating	19
	■ Special operating programs and functions	19
	Procedure for setting a time program	19
	■ Time programs and time phases	20
	■ Setting time phases	20
	■ Copying the time program to other days of the week	21
	■ Changing time phases	21
	■ Deleting time phases	21
4. Default displays	Default display "Indoor environment"	22
	"DHW" default display	22
	"Energy cockpit" default display	22
	■ Checking the heat pump operating data	23
	■ Calling up the energy balance	23
	"Favourites" default display	23
	"System overview" default display	24
5. Room heating/room cooling	Selecting a heating/cooling circuit	25
	Setting the room temperature for a heating/cooling circuit	25
	■ Setting temperature levels for room heating/room cooling	25
	Switching room heating/room cooling on or off (operating program)	25
	Time program room heating/room cooling	26
	■ Setting the time program	26
	Setting the heating curve	26
	Temporarily adjusting the room temperature	27

Index

	■ Switching on "Extend time phase once"	27
	■ Switching off "Extend time phase once"	27
	Adjusting the room temperature for longer periods at home	28
	■ Switching on "Holidays at home" 	28
	■ Switching off "Holidays at home" 	28
	Saving energy during long periods of absence	28
	■ Switching on the "Holiday program" 	29
	■ Switching off the "Holiday program" 	29
6. DHW heating	DHW temperature	30
	Switching DHW heating on/off (operating program)	30
	Time program for DHW heating	30
	■ Setting a time program	30
	■ Setting the time program for the DHW circulation pump	30
	"One-off DHW heating" outside the time program	31
	■ Switching on "One-off DHW heating"	31
	■ Switching off "One-off DHW heating"	31
	Increased DHW hygiene	31
	■ Switching on increased DHW hygiene	31
	■ Switching off increased DHW hygiene	32
	Switching DHW scald protection on/off	32
7. Advanced	Quieter operation	33
	■ Setting the time program for quieter operation	33
	■ Operating status for quieter operation	33
	Switching emergency mode on/off	33
8. Further adjustments	Disabling operation	34
	■ Unlocking the controls	34
	■ Changing the password for the "Lock panel" function	34
	Setting the display brightness	34
	Switching the Lightguide on and off	35
	Adjusting the signal tone for on-screen buttons	35
	Naming heating/cooling circuits	35
	Setting the "Time" and "Date"	36
	Automatic "Summer/wintertime" changeover	36
	Setting the "Language"	36
	Setting "Units"	36
	Entering the contractor's contact details	36
	Setting the home screen	37
	Switching internet access on or off	37
	■ Switching WiFi on/off	37
	■ Establishing a WiFi connection	37
	■ Static IP addressing	38
	Switching off the display screen for cleaning	38
	Restoring factory settings	38
9. Checks	Calling up help messages	40
	Checking information	40
	Calling up licence information for the programming unit	40
	Calling up licence information for the integral communication module TCU201	40
	■ Calling up the license information for third party components	41
	■ Third party software	41
	Calling up licence information for the integral communication module TCU300	42
	■ Calling up the heat pump IP address	42
	Screed drying	42
	Checking service messages	42
	■ Calling up a service message	43

	Checking fault messages	43
	■ Calling up a fault message	43
	Checking message lists	44
10. Switching on and off	Shutting down the heat pump	45
	■ With frost protection	45
	■ Without frost protection monitoring (shutting down the system)	45
	Starting the heat pump	45
	Position of the ON/OFF switch	45
	■ Wall mounted indoor unit	45
	■ Floorstanding indoor unit with integral DHW cylinder	46
11. What to do if...	Rooms are too cold	48
	Rooms are too hot	48
	There is no hot water	49
	The DHW is too hot	49
	"Warning" is displayed	49
	"Fault" is displayed	49
	"External hook-up" is displayed	49
	🔧 and "Service" are displayed	50
	"Panel locked" is displayed	50
12. Maintenance	Cleaning	51
	Inspection and maintenance	51
	■ DHW cylinder	51
	■ Safety valve (DHW cylinder)	51
	■ Potable water filter (if installed)	52
	Damaged cables / lines	52
13. Appendix	Overview of "Main menu"	53
	Information on disposal	56
	■ Disposal of packaging	56
	■ Final decommissioning and disposal of the heating system	56
14. Keyword index	57

Safety zone

Your outdoor unit contains easily flammable refrigerant in safety group A3 according to ISO 817 and ANSI/ASHRAE Standard 34.

Therefore a safety zone is defined in the immediate vicinity of the outdoor unit, in which special requirements apply.

Note

The requirements for the safety zone must be complied with completely.

The following conditions must not be present or occur within the safety zone:

- Building openings, e.g. windows, doors, light wells, flat roof windows, etc.
- Outdoor air and exhaust air apertures from ventilation and air conditioning systems
- Property boundaries, neighbouring properties, footpaths and driveways
- Pump shafts, inlets to waste water systems, downpipes and waste water shafts, etc.
- Other slopes, troughs, depressions, shafts
- Electrical house supply connections
- Electrical systems, sockets, lamps, light switches
- Snowfall from roofs

Do not introduce ignition sources into the safety zone:

- Naked flames or burner gauze assemblies
- Grills
- Tools that generate sparks
- Electrical devices not free of ignition sources, mobile devices with integrated batteries (e.g. mobile phones, fitness watches, etc.)
- Objects with temperatures above 360 °C

Note

The particular safety zone is dependent on the surroundings of the outdoor unit.

- The safety zones below are shown with floorstanding installation. These safety zones also apply to other types of installation.
- In the case of wall installation, the requirements listed above also apply to the area **below** the outdoor unit, down to the ground.

Freestanding positioning of the outdoor unit

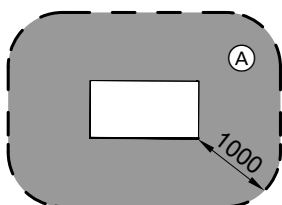

Fig. 1

Ⓐ Safety zone

Siting the outdoor unit in front of an external wall

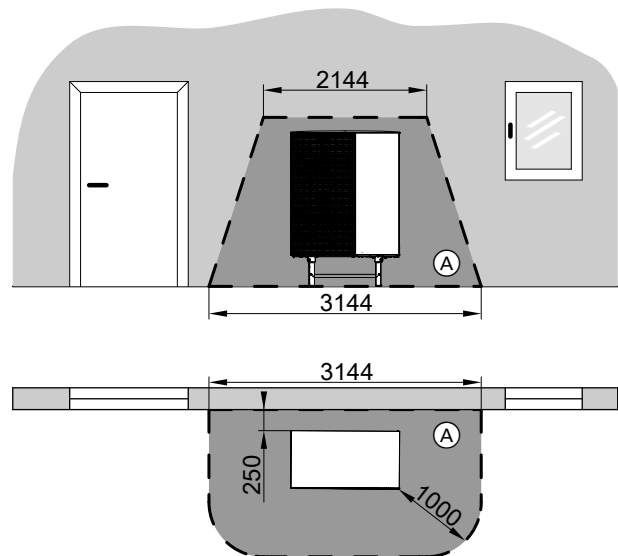

Fig. 2

Ⓐ Safety zone

Corner positioning of the outdoor unit, right

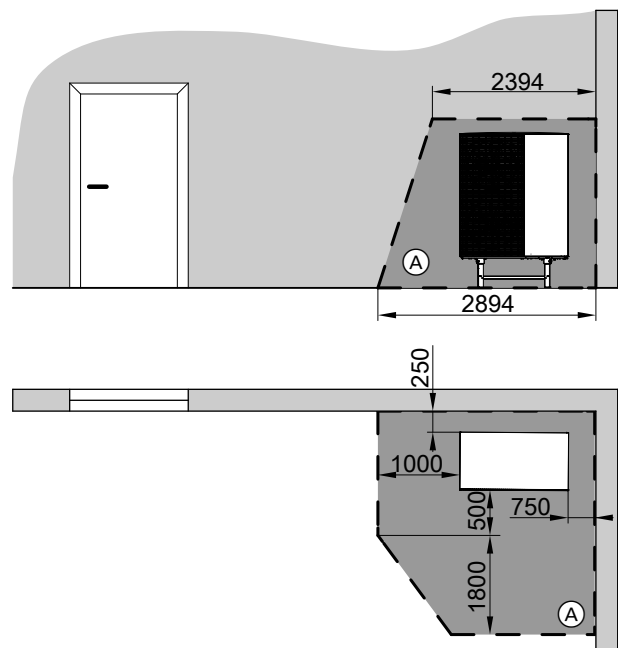

Fig. 3

Ⓐ Safety zone

Corner positioning of the outdoor unit, left

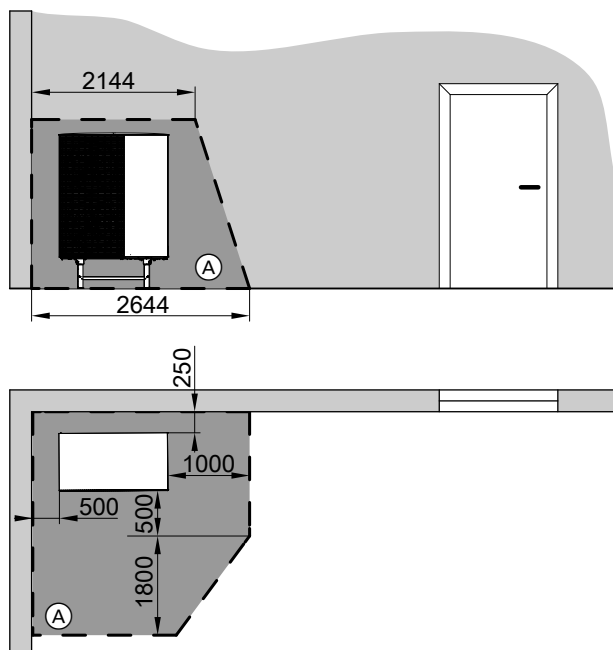

Fig. 4

Ⓐ Safety zone

Liability

No liability is accepted for loss of profit, unattained savings, or other direct or indirect consequential losses resulting from use of the WiFi interface integrated into the system or the corresponding internet services. No liability is accepted for losses resulting from inappropriate use.









Liability is limited to typical damage arising if a fundamental contractual obligation is violated through slight negligence, the fulfilment of which is essential for proper execution of the contract.

The limitation of liability shall not apply if the damage was caused deliberately or through gross negligence, or if mandatory liability applies due to product liability legislation.





The Viessmann General Terms and Conditions apply, which are included in each current Viessmann pricelist. The relevant data protection regulations and terms of use apply to the use of Viessmann apps. Viessmann accepts no liability for push notifications and email services, which are provided by network operators. The terms and conditions of the respective network operators therefore apply.

Symbols

Symbols in these instructions

Symbol	Meaning
	Reference to other document containing further information
	Step in a diagram: The numbers correspond to the order in which the steps are carried out.
	Warning of material losses and environmental pollution
	Live electrical area
	Pay particular attention.
	<ul style="list-style-type: none"> ▪ Component must audibly click into place. or ▪ Acoustic signal
	<ul style="list-style-type: none"> ▪ Fit new component. or ▪ In conjunction with a tool: Clean the surface.
	Dispose of component correctly.
	Dispose of component at a suitable collection point. Do not dispose of component in domestic waste.

Symbols on the heat pump

Symbol	Meaning
	Warning of flammable materials (ISO 7010 - W021)
	Observe the operating manual (ISO 7000 - 0790)
	Observe the instructions for use/operating instructions (ISO 7000 - 1641)
	Service indicator: Refer to the operating manual (ISO 7000 - 1659)

Intended use

The appliance is only intended to be installed and operated in sealed unvented heating systems that comply with EN 12828, with due attention paid to the associated installation, service and operating instructions.

Depending on the version, the appliance can only be used for the following purposes:

- Central heating
- Central cooling
- DHW heating

The range of functions can be extended with additional components and accessories.

Intended use presupposes that a fixed installation in conjunction with permissible, system-specific components has been carried out.

Commercial or industrial usage for a purpose other than central heating/cooling or DHW heating shall be deemed inappropriate.

Incorrect usage or operation of the appliance (e.g. the appliance being opened by the system user) is prohibited and will result in an exclusion of liability. Incorrect usage also occurs if the components in the heating system are modified from their intended function.

Introductory information

Intended use (cont.)

Note

The appliance is intended exclusively for domestic or semi-domestic use, i.e. even users who have not had any instruction are able to operate the appliance safely.

Product information

Your air source heat pump consists of an indoor unit and an outdoor unit.

The indoor unit, including the heat pump control unit, is inside the building and transfers the heat to the heating system.

The outdoor unit is installed outside the building or fitted to the outside of the building. Heat is obtained from the ambient air in the outdoor unit.

To achieve this, a fan draws the ambient air through a heat exchanger (evaporator). In the evaporator, the thermal energy from this ambient air is transferred to the refrigerant circuit. Here, the temperatures necessary for room heating and DHW heating are generated.

To provide room cooling, the refrigerant circuit operates in reverse mode. Heat is extracted from your rooms and transferred to the ambient air via the evaporator.

The refrigerant circuit is driven by the compressor.

Compared with the heat energy derived from the air, the compressor only requires a small amount of electrical power. This power is often provided at a favourable tariff by your power supply utility.

Dependent upon the tariff conditions and the power supply, your power supply utility may make short-term interruptions to the heat pump power supply (power-OFF), e.g. if there is high network load.

During power-OFF, the instantaneous heating water heater built into the indoor unit can take over the heat supply to the building. This instantaneous heating water heater is then automatically switched on if the heating output of the heat pump is insufficient or there is a fault in the heat pump.

Type plate

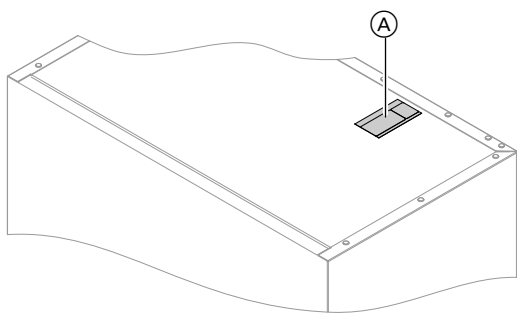

Fig. 5

Ⓐ Type plate and QR code for appliance registration

The **QR code with designation "i"** contains the access data for the registration and product information portal. This allows e.g. the 16-digit serial number to be read out via the QR-Code.

Heat pump control unit

The heat pump control unit is integrated into the indoor unit and controls all functions of your system. The control unit is operated via a 7 inch touchscreen.

Communication modules for the following functions are integrated into the heat pump control unit:

- Connection to a WiFi router, e.g. for remote control via the internet with an app.
- Direct WiFi connection to a mobile device ("access point")

- Data transmission via mobile phone network
- Connection of wireless accessories, e.g. remote control

Product information (cont.)**Permissible ambient temperatures in the installation room****Please note**

The appliance may develop faults if it is operated outside the specified temperature ranges. Ensure that the specified temperature range is maintained in the installation room.

To prevent malfunctions, ensure the ambient temperature is between 0 °C and +35 °C.

Outside temperature limits

Air/water heat pumps utilise outdoor air as the heat source. Operation is only efficient within specified outdoor temperature limits:

- **Room heating**
-20 to 40 °C
- **Room cooling**
10 to 45 °C

If the temperature rises above the upper limit or falls below the lower limit, the outdoor unit is shut down. You will see a message about this on the heat pump control unit.

To cover the heat demand for room heating and DHW heating even outside the specified temperature range, the heat pump control unit switches on the instantaneous heating water heater automatically. Once the outside temperature is back within the temperature limits, the heat pump is automatically ready for operation again.

Safety zone

Your outdoor unit contains easily flammable refrigerant in safety group A3 according to ISO 817 and ANSI/ASHRAE Standard 34.

A safety zone is defined in the immediate vicinity of the outdoor unit, in which special requirements apply: See page 9.

Service link

The service link provides digital, internet based support, in which automatically selected information is transmitted to the Viessmann service control centre, e.g. system operating data or fault reports. Data protection information can be found under "viessmann.com/servicelink".

With the service link, data transfer is guaranteed for a period of 5 years from installation of the system. The right to subsequent use of the service link remains reserved.

Low power radio

Low power radio is a wireless connection for data transfer, e.g. via a remote control unit.

Your heating contractor can connect your heat generator with Viessmann accessories via low power radio.

Licence information

This product contains third party software including software of "third party components". You are authorised to use this third party software subject to compliance with the relevant licensing terms.

- Licence information for the programming unit: See page 40.
- Licence information for the integral communication module TCU201: See page 40.
- Licence information for the integral communication module TCU300: See page 42.

Commissioning

The commissioning and matching up of the heat pump control unit to local conditions and to the structural characteristics of the building, plus the instruction of the user in operating the system, must be carried out by your heating contractor.

Note

These operating instructions also describe functions that are only available on some heat pump models or only with accessories. These functions are not specifically identified.

For questions relating to the scope of and accessories for your heat pump and your heating system, contact your contractor.

Your system is preset at the factory

Your heat pump is preset at the factory and is therefore ready for operation:

Room heating/room cooling

- Your home will be heated to 20 °C from **06:00 to 22:00 h "Room set temperature"** (standard room temperature).
- If a separate buffer cylinder is installed, this buffer cylinder will be heated.

DHW heating

- DHW is heated to **"Set DHW temperature"** 50 °C every day from **05:30 to 22:00**.
- Any installed DHW circulation pump is switched off.
- If required, the instantaneous heating water heater built into the indoor unit can be switched to DHW heating.

Frost protection

- Frost protection is ensured for your heat pump, DHW cylinder and any separate buffer cylinder that may be installed.

Note

For outside temperatures below -20 °C and in the case of a fault in the heat pump, only instantaneous heating water heater built into the indoor unit is switched on to provide frost protection for the system.

Wintertime/summertime changeover

- This changeover is automatic.

Date and time

- The date and time were set by your contractor.

You can change the settings at any time to suit your individual requirements.

Power failure

All settings are retained if there is a power failure.

Energy saving tips

Saving energy when using room heating

- Do not overheat your home. Every degree of room temperature reduction saves up to 6 % on your heating bills.
Do not set your standard room temperature ("**Room set temperature**") to above 20 °C: See page 25.
- Heat your home to the reduced room temperature at night or during regular absences (not applicable to underfloor heating). For this, adjust the settings in the time program for room heating ("**Time program**"): See page 26.
- Adjust the heating curves so that your home is heated with your individual preferred temperature all year round: See page 26.

- To switch off functions that are not required (e.g. room heating in summer), set the operating program to "**Standby mode**" for the relevant heating circuits: See page 25.
- If you are going away, set the "**Holiday program**": See page 29.
During the period that you are away, the room temperature will be reduced and DHW heating switched off.

Energy saving tips (cont.)

Saving energy on DHW heating

- At night or during regular absences, heat the DHW to a lower temperature. To do so, adjust the time program for DHW heating: See page 30.
- Switch on DHW circulation only for those times in which you regularly use hot water. For this, adjust the time program for the DHW circulation pump: See page 30.

Utilising excess power (Smart Grid)

Utilise free or cheap excess power from the power supply utility for your heating system. To use this function, please contact your heating contractor.

Tips for greater comfort

More comfort in your home

- Set your individual preferred temperature: See page 25.
- Adjust the time program for your heating/cooling circuits so that your individual preferred temperature is automatically reached when you are present: See page 26.
- Adjust the heating curve so that your home is heated with your individual preferred temperature all year round: See page 26.
- If you need a longer heating/cooling phase in the short term, select the **"Extend time phase once"** function: See page 27.
Example:
Late in the evening, the reduced room temperature is set by the time program. Your guests stay longer.
- If you are spending more time than usual in your home, select the  **"Holidays at home"** function: See page 27.
Example:
You are on holiday at home all day or your children have school holidays.

Sufficient DHW heating for your needs

- Adjust the time program for DHW heating so that there is always sufficient hot water in accordance with your habitual routines: See page 30.
Example:
You need more DHW in the morning than in the daytime.
- Adjust the time program for the DHW circulation pump so that DHW is available immediately from the taps during periods when hot water is drawn more frequently: See page 30.
- If you need your DHW temperature to be higher for a short while, select "One-off DHW heating outside the time program": See page 31.

Quieter operation

Reduce the noise level of your air source heat pump, at night for instance.

To do so, adjust the time program for quieter operation: See page 33.

Operating principles

Touchscreen

You can adjust any setting on your system centrally at the programming unit.

The programming unit is equipped with a **touch display**. To input settings and check information, tap the on-screen buttons.

Status display with Lightguide

Dependent upon the heat generator, during operation at the lower or upper edge of the programming unit, a Lightguide is displayed.

Note

You can switch off the Lightguide. See page 35.

Meaning of the display:

- Lightguide pulsates slowly:
Display is in standby mode.
- Lightguide is illuminated constantly:
You are operating the control unit. Every input operation is confirmed by a brief flashing of the Lightguide.
- Lightguide flashes quickly:
There is a fault in the system.

Screen displays

Standby display

If the controls have not been operated for some time, the display initially switches to the **standby display**.

After a few minutes, the illumination is switched off.

Default displays

The default displays provide access to the most important settings and checks.

- Energy cockpit
- Favourites
- System overview

You can choose between the following default displays using ◀▶:

- Indoor environment
- DHW

For further information on the default displays: See page 22 onwards.

Home screen

After switching on the control unit, the home screen is shown.

In the delivered condition, the **"Indoor environment"** default display is shown as the home screen. You can specify a different default display for the home screen: See page 37.

Note

You can prevent operation of the home screen: See page 34.

If you do so, you will not be able to make adjustments on either the home screen or the main menu.

***"Panel locked"** is displayed.*

Call up the home screen as follows:

- Standby display active:
Tap anywhere on the screen.
- From the **"Main menu"**:
Tap .

Buttons and symbols

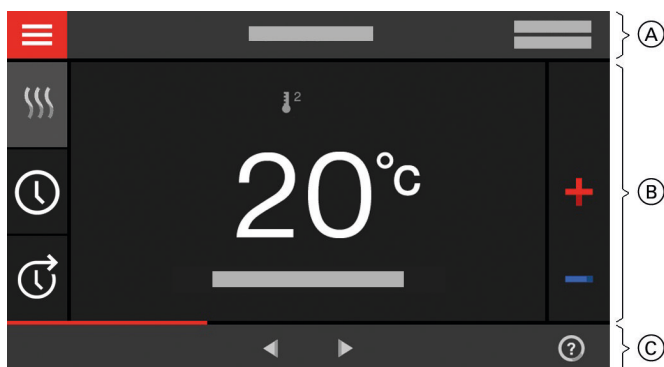



Fig. 6

- (A) Menu bar
- (B) Function area
- (C) Navigation area



Buttons and symbols in menu bar (A)







 Calls up the "Main menu".
"Heating circuit ..." Selects the heating/cooling circuit.
Note
This choice is only available if there are several heating/cooling circuits in your system.

System data:

- Date
- Time

Interfaces:

-  No data transfer
-  No WiFi connection

-  Establishing a connection
-  Communication error
-  WiFi connection is enabled: Very low reception quality
-  WiFi connection is enabled: Low reception quality
-  WiFi connection is enabled: Medium reception quality
-  WiFi connection is enabled: High reception quality











Buttons and symbols in function area (B)



For buttons on the default displays: See page 22 onwards.

Note





These symbols are not always displayed, but appear subject to the system version and the operating status.

Symbols

-  Frost protection is active.
-  Setting/changing a time program
-  Extend time phase once.
-  Room heating with reduced room temperature
-  Room heating with standard room temperature
-  Room heating with comfort room temperature
-  Room cooling with standard room temperature
-  Room cooling with comfort room temperature
-  Holiday program is switched on.
-  Holidays at home is switched on.

-  Room cooling is active.
-  Room heating is active.

Operating program for room heating, room cooling, DHW heating: See page 19.









-  Standby mode for each of the heating/cooling circuits
-  Heating
-  Cooling
-  DHW heating

Reports: See page 44.

- "Status"
- "Warnings"
- "Information"
- "Faults"
- "Service messages"

Buttons and symbols (cont.)

Buttons and symbols in navigation area

-  Takes you back to the home screen.
-  Takes you one step back in the menu.
Or
Terminates an adjustment in progress.
-  WiFi is switched off: See page 37.
-  Confirms a change.
-  Makes changes in the menu.
-  Calls up the help text.
-  Calls up messages.
-  Calls up the required period for the energy balance.
For further information: See page 23.
-  Scrolls through the menu.
Or
Switches to other display areas, e.g. to the **"System overview"**.





Note

If **"DEMO"** is displayed in the navigation area, there is no room heating, no DHW heating and no frost protection.











Overview of the "Main menu"

In the **"Main menu"**, you can check and adjust **all** of the settings for the control unit's range of functions.

Call up the **"Main menu"** as follows:

- If the screensaver is active:
Tap anywhere on the screen and then tap .
- From the home screen:
Tap .
- From anywhere in the menu:
Tap  and then .

Menus available in the "Main menu"

- | | |
|---|--|
| <ul style="list-style-type: none">  "Switch on/off"
Switch the heat pump off and on: See page 45.  "Indoor environment"
For more room heating/room cooling settings, e.g. set temperature values
For further information: See page 25.  "DHW"
For DHW heating settings, e.g. "DHW temperature set value"
For further information: See page 30.  "Settings"
For example the  display setting
For further information: See page 34.  "Information"
For checking operating data
For further information: See page 40.  "Holiday program"
Energy saving function "Holiday program"
For further information: See page 28. | <ul style="list-style-type: none">  "Holidays at home"
"Holidays at home" function
For further information: See page 28.  "Message lists"
Calls up all pending messages
For further Information regarding reports: See page 42 onwards.  "Service"
For contractors only  "Advanced"
For the processing of further settings from the function range of the heat pump control unit, e.g. emergency mode
For further information: See page 33.
You can find the menu overview on page 53. |
|---|--|

Operating program

Operating programs for room heating, room cooling and DHW heating

The operating programs for room heating, room cooling and DHW heating can be set separately.

Symbol	Operating program	Function
Room heating/room cooling		
☰	"Heating"	The rooms of the selected heating/cooling circuit are heated in accordance with the specified room temperature or flow temperature and the time program: See chapter "Room heating/room cooling".
✳	"Cooling"	The rooms of the selected heating/cooling circuit are cooled in accordance with the specified room temperature or flow temperature and the time program: See chapter "Room heating/room cooling".
☰*	"Heating/cooling"	The rooms of the heating/cooling circuit are heated/cooled as specified for the room temperature and time program: See chapter "Room heating/room cooling".
⏻	"Standby mode"	<ul style="list-style-type: none"> ▪ No room heating/room cooling ▪ Frost protection for the heat generator is active.
DHW heating		
⏻	"DHW" "ON"	DHW is heated in accordance with the specified DHW temperature and time program: See chapter "DHW heating".
⏻	"DHW" "OFF"	<ul style="list-style-type: none"> ▪ No DHW heating ▪ Frost protection for the DHW cylinder is active.

Special operating programs and functions

▪ "Screed drying"

This function is switched on by your contractor. Your screed is dried in line with a set time program (temperature/time profile) suitable for the relevant building materials. Your settings for room heating have no effect on the duration of screed drying (max. 32 days). DHW heating is switched off. The **"Screed drying"** function can be altered or switched off by your contractor.

▪ "External hook-up"

The operating program set at the control unit was changed over by an external device, e.g. an EM-EA1 extension (DIO electronics module). The operating program cannot be changed via the control unit for as long as the external hook-up is enabled.

▪ **"Holiday program"**: See page 29.

▪ **"Holidays at home"**: See page 28.

Note

The special operating programs and functions are displayed alternately with the room temperature or the flow temperature of the heat pump.

*In the main menu, you can call up the set operating program under **"Information"**: See page 40.*

Procedure for setting a time program

The following explains how to input the settings for a time program. The specifics of the individual time programs can be found in the relevant chapters.

You can set up a time program for the following functions:

- Room heating/room cooling: See page 25.
- DHW heating: See page 30.

- DHW circulation pump: See page 30.
- Quieter operation: See page 33.

Procedure for setting a time program (cont.)

Time programs and time phases

In the time programs you determine what your heat pump should do at what time. To do so, divide the day into sections. These are called **time phases**. Inside and outside these time phases. The system behaves differently in accordance with the following table.

You can set up a time program for the following functions:

Function	Within the time phase	Outside the time phase
Room heating	Your rooms are heated with standard room temperature or comfort room temperature.	Your rooms are heated with reduced room temperature.
Room cooling	Your rooms are cooled with standard room temperature or comfort room temperature.	The rooms are not cooled.
DHW heating	DHW heating is switched on. The water in the DHW cylinder is heated to the set DHW temperature.	DHW heating is switched off.
DHW circulation pump	The DHW circulation pump is switched on.	The DHW circulation pump is switched off.
Quieter operation	The speed of the fan and the compressor is limited.	The maximum speed of the fan and the compressor is enabled.

- The time programs can be set **individually** to be the same, or different, for every day of the week.
- In the main menu, you can check the time programs under ⓘ **"Information"**: See page onwards.

Setting time phases

The procedure is explained using the example of room heating for heating/cooling circuit 1.

You can set up to 4 time phases in each **"Time program"**.

For each time phase, you define the start point **"Start"** and the end point **"End"**.

Example:

"Time program" for the weekday **"Monday"** for heating/cooling circuit 1

- Time phase 1:
06:45 to 12:00 with standard room temperature

- Time phase 2:
15:00 to 20:00 with comfort room temperature

In between these time phases the system heats to a reduced temperature.

Tap the following buttons:

1. **"Heating/cooling circuit 1"** ✓ in the menu bar
2. ⓘ
3. **"Mo"**
4. ✎

5. ⤴ ⤵ for the **"Start"** and **"End"** of time phase 1. The bar in the time diagram is adjusted.
6. ⓘ **"Normal"** to select standard room temperature.
7. + to add time phase 2.
8. ⤴ ⤵ for the **"Start"** and **"End"** of time phase 2.

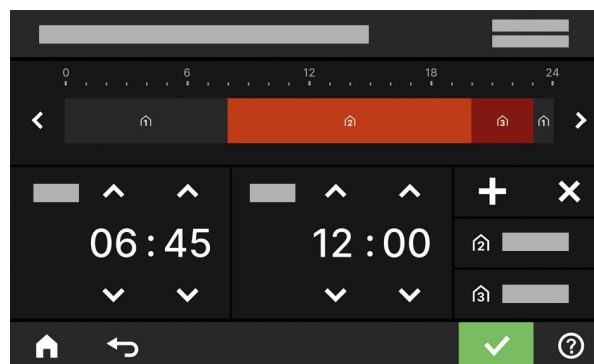

Fig. 7

The bars in the time diagram are adjusted.

9. ⓘ **"Comfort"** to select comfort room temperature.
10. ✓ to confirm

Procedure for setting a time program (cont.)

11.  to quit the "Time program".



Copying the time program to other days of the week



The procedure is explained using the example of room heating for heating/cooling circuit 1.

Example:

You want to copy the "Monday" "Time program" over to "Thursday" and "Friday".

Tap the following buttons:

1. "Heating/cooling circuit 1"  in the menu bar
2. 

3. "Mo"
4. 
5. "Th", "Fr"
6.  to confirm
7.  to quit the time program.



Changing time phases









The procedure is explained using the example of room heating for heating/cooling circuit 1.

Example:

For "Monday" you want to change the start point "Start" for time phase 2 to 19:00 h.

Tap the following buttons:

1. "Heating/cooling circuit 1"  in the menu bar
2. 
3. "Mo"

4. 
5.  for time phase 2
6.  for the start point of time phase 2.
The bar in the time diagram is adjusted.
7.   "Normal" for standard room temperature
or
  "Comfort" for comfort room temperature
8.  to confirm
9.  to quit the time program.



Deleting time phases





The procedure is explained using the example of room heating for heating/cooling circuit 1.

Example:

For Monday you want to delete time phase 2.

Tap the following buttons:

1. "Heating/cooling circuit 1"  in the menu bar
2. 

3. "Mo" to select the required day
4. 
5.  for time phase 2
6.  to delete the time phase.
7.  to confirm
8.  to quit the time program.

Default displays

Default display "Indoor environment"

In the **"Indoor environment"** default display you can carry out the room heating and room cooling settings and checks you use most frequently:

- + Raises the room temperature value.
- Lowers the room temperature value.
- ⋮ Sets the **"Heating"** operating program for a heating/cooling circuit.
- * Sets the **"Cooling"** operating program for a heating/cooling circuit.

- ⋮* Sets the **"Heating/cooling"** operating program for a heating/cooling circuit.
- ↻ Switches the **"Extend time phase once"** function on or off.
- ⌚ Calls up the **"Time program"** for room heating/room cooling.

The displayed temperature is the set room temperature for the current time phase, e.g. 20 °C.

"DHW" default display

In the **"DHW"** default display you can carry out the DHW settings and checks you use most frequently:

- + Raises the DHW temperature value.
- Lowers the DHW temperature value.

- ⏻ Sets the **"DHW"** to **"ON"**.
- ⏻ Sets the **"DHW"** to **"OFF"**.
- ⌚ Calls up the **"Time program"** for DHW heating.
- ⏻ Switches one-off DHW heating on or off.

"Energy cockpit" default display

The **"Energy cockpit"** provides you with clear information on the energy state of your heat pump. The various components present in the system are shown as graphics. Some information on the components is also provided in the default display. For more information, tap on the currently displayed component. What buttons and symbols are available depends on the system version.

If you call up the energy cockpit for the first time, a notification appears.

- Confirm the notification with ✓. The energy cockpit is displayed. The notification is not shown again when the energy cockpit is subsequently called up.
- With **"Cancel"** the notification is closed. The energy cockpit is displayed. The notification will be shown again next time the energy cockpit is called up.

- Ⓒ Heat pump flow temperature
- Ⓓ DHW cylinder
- Ⓔ Heating of the DHW cylinder by the heat pump is enabled.
- Ⓕ Heat pump
Check the heat pump operating data.
For additional information: See chapter "Checking the heat pump operating data".
- Ⓖ Energy balance
Check the power consumption of the compressor and electrical booster heater.
For additional information: See chapter "Calling up the energy balance".

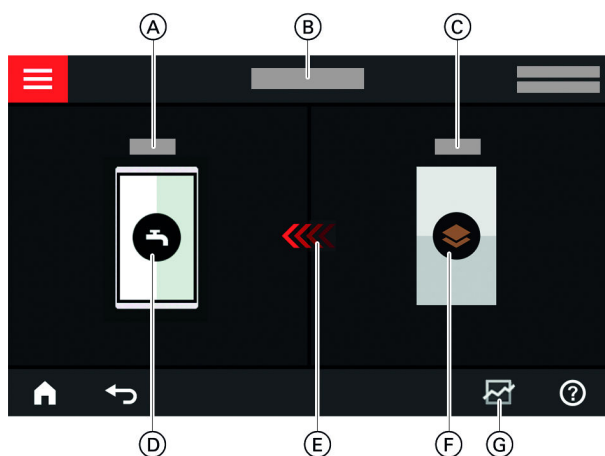





Fig. 8

- Ⓒ DHW temperature
- Ⓓ Energy cockpit

"Energy cockpit" default display (cont.)**Checking the heat pump operating data**

In the energy cockpit default display you can find the operating data for the heat pump.

Tap the following buttons:

1.  for the "Energy cockpit" default display
2. 
3.  for the required check

You can call up the following operating data:

- SCOP of the system
 - Thermal energy generated
 - Energy consumption
- SCOP for heating
 - Thermal energy generated
 - Energy consumption
- SEER for cooling
 - Thermal energy generated
 - Energy consumption
- SCOP for DHW
 - Thermal energy generated
 - Energy consumption

- Power consumption of compressor
 - Power consumption this month
 - Power consumption last month
 - Power consumption this year
 - Power consumption last year
- Power consumption of electric booster heater
 - Power consumption this month
 - Power consumption last month
 - Power consumption this year
 - Power consumption last year

Note



The consumption figures displayed are not based on metering instruments but instead are computed values. The calculation takes into account the existing system components and the user behaviour, e.g. operating time and utilisation level.

Depending on system-specific parameters (e.g. installation altitude), differences may arise between the displayed (computed) and actual consumption values. Due to seasonal climate conditions and other factors, further discrepancies are possible. The value display serves to visualise any consumption increases or decreases in relation to specific comparative periods. The use of the displayed consumption values as a basis for invoicing is not permitted.

Calling up the energy balance

In the energy balance, you can display the power consumption of your heat pump or the built-in instantaneous heating water heater for a required period.

Tap the following buttons:

1.  for the "Energy cockpit" default display
2. 

3. Selection:
 - Power consumption of compressor
 - Power consumption of electric booster heater
4. Required period :
 - Current month
 - Last month
 - Current year
 - Last year

"Favourites" default display

In the "Favourites" default display you can call up your own preferred menus. You can add a maximum of 12 menus to Favourites. You can change the selection at any time.

Labelling menus as favourites**Tap the following buttons:**

1.  for the "Favourites" default display

2. 

The list of menus available for selection is shown.
3. for all preferred menus

The selection is indicated by .
4.  to confirm

"System overview" default display

Subject to your system equipment and the settings that have been made, you can check the following current system data on the "**System overview**" default display:

- System pressure
- Heat pump flow temperature
- Outside temperature
- Heating/cooling circuit flow temperature
- DHW temperature
- Status of the internet connection
- Service, heating contractor contact details
- Open source licences

Tap the following buttons:

1. ◀▶ for the "**System overview**" default display
2. **Checking other information:**
 - ▶ for further system data
 - Or
 - ℹ to call up the "**Information**" menu.

Note

Detailed options for checking the individual system data can be found in chapter "Menu overview".

Selecting a heating/cooling circuit

The heating/cooling of all rooms can be distributed amongst several heating/cooling circuits, e.g. a heating/cooling circuit for your apartment, and a heating/cooling circuit for your office.

In the menu bar, the following designations are used at the factory: **"Heating/cooling circuit 1"**, **"Heating/cooling circuit 2"**, etc. You can alter these designations: See chapter "Naming heating/cooling circuits".

- If your system has several heating/cooling circuits, in **"Indoor environment"** in the default display, first select the heating/cooling circuit for all room heating/room cooling settings that you want to change.
- If there is only one heating/cooling circuit, this selection option is not available.

Example: Select heating/cooling circuit 3.

Tap the following buttons:

1. ◀▶ for the default display **"Indoor environment"**
2. **"Heating/cooling circuit 1"** ▼ in the menu bar
3. Tap on **"Heating/cooling circuit 3"**.

Setting the room temperature for a heating/cooling circuit

The standard room temperature is the temperature at which you feel comfortable. Your home is always heated or cooled to this temperature when a time phase with the temperature level **"Standard"** is active in the time program.

Set the time program for room heating/room cooling:
See page 26.

Factory settings:

Room heating

- Standard room temperature: 20 °C
- Reduced room temperature: 18 °C
- Comfort room temperature: 22 °C

Room cooling

- Standard room temperature: 24 °C
- Reduced room temperature: 27 °C
- Comfort room temperature: 23 °C

Setting temperature levels for room heating/room cooling

Tap the following buttons:

1. ◀▶ for the default display **"Indoor environment"**
2. ▼ for the required heating/cooling circuit

3. ⚡ for the required value of the relevant temperature level:
 - ⌆₁ **"Reduced"**
 - ⌆₂ **"Standard"**
 - ⌆₃ **"Comfort"**

4. ✓ to confirm

Switching room heating/room cooling on or off (operating program)

For information on the operating programs: See page 19.

Tap the following buttons:

1. ◀▶ for the default display **"Indoor environment"**
2. ▼ for the required heating/cooling circuit

3. Select ☰, ✱, ☰* or ⏻.
 - ☰ Switches the room heating on.
 - ✱ Switches the room cooling on.
 - ☰* Switches on room heating/room cooling.
 - ⏻ Switches standby mode on. Room heating and room cooling are switched off.

4. ✓ to confirm

Time program room heating/room cooling

In the time programs for room heating and room cooling you set the time phrases during which your home is heated or cooled and to what temperature.

Setting the time program

Factory setting: **One** time phase from 06:00 to 22:00 h for every day of the week with the **"Standard"** temperature level.

Adjust the time program for room heating or room cooling.

The procedure is explained using the example of room heating for heating/cooling circuit

Tap the following buttons:

1. ◀▶ for the default display **"Indoor environment"**
2. ✓ for the required heating/cooling circuit
3. ⌚
4. Required day of the week

5. ✎
6. Depending on the required change:
 - ^✓ for changing the beginning and end of the selected time phase
 - +
 - ✕ for a new time phase
 - ▶◀ to delete a time phase
 - ◀▶ to select the time phase if more than one time phase is set.

Note

When adjusting the setting, bear in mind that your system requires some time to heat the rooms to the required temperature.

To continue: See page 19.

Setting the heating curve

To ensure your rooms are heated optimally at any outside temperature, you can adjust the **"Level"** and **"Slope"** of the **"Heating curve"**. This enables you to influence the flow temperature of the heat pump.

Factory settings

	"Slope"	"Level"
Heating curve	1.4	0

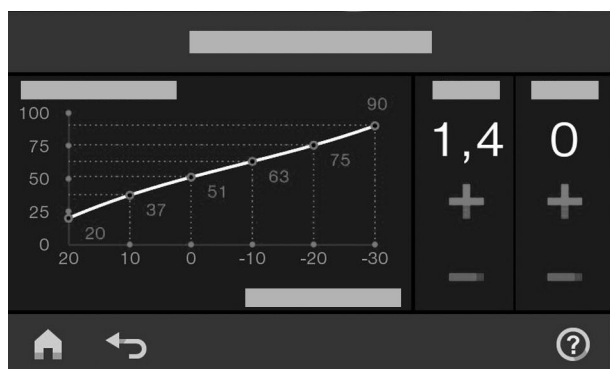

Fig. 9

The procedure is explained using the example of heating/cooling circuit 1.

Tap the following buttons:

1. ☰
2. 🏠 **"Indoor environment"**
3. Required heating/cooling circuit, e.g. ① **"Heating/cooling circuit 1"**
4. ⌵ **"Heating curve"**
5. + - for the required value for **"Slope"** and **"Level"** respectively
The diagram indicated shows the change in the **"Heating curve"** clearly.
6. ✓ to confirm

Setting the heating curve (cont.)

Tips for setting the "Heating curve"

Room temperature behaviour	Remedy
The home is too cold during the winter.	Set the "Slope" to the next level up.
The home is too warm during the winter.	Set the "Slope" to the next level down.
The home is too cold during the spring/autumn and winter.	Set the "Level" to a higher value.
The home is too warm during the spring/autumn and winter.	Set the "Level" to a lower level.
The home is too cold during the spring/autumn but warm enough during the winter.	Set the "Slope" to the next level down and "Level" to a higher value.
The home is too warm during the spring/autumn but warm enough during the winter.	Set the "Slope" to the next level up and "Level" to a lower value.

Temporarily adjusting the room temperature

If you wish to adjust the room temperature temporarily, select the  **"Extend time phase once"** function. This function is **independent** of the time program for room heating/room cooling.

- The rooms will be heated/cooled with the temperature of the last active time phase for standard room temperature or comfort room temperature.
- If your contractor has not made alternative adjustments, DHW is heated to the selected DHW temperature **first**, before room heating/room cooling commences.
- The DHW circulation pump is switched on (if installed).

Switching on "Extend time phase once"

Tap the following buttons:

1.  for the required heating/cooling circuit

2. 

The temperature of the last active time phase for standard room temperature or comfort room temperature will be set.

Switching off "Extend time phase once"

The function ends automatically when switching to the next time phase for standard room temperature or comfort room temperature.

2. 

To terminate **"Extend time phase once"** early, tap the following on-screen buttons:

1.  for the required heating/cooling circuit

Adjusting the room temperature for longer periods at home

If you are continuously at home for one or more days but do not want to change the time program, select the function **"Holidays at home"** , e.g. on public holidays or when the children are on school holidays.

The function **"Holidays at home"**  has the following effect:

- The room temperature during the periods between the set time phases is raised to the set value of the first time phase of the day: From reduced room temperature to standard room temperature or comfort room temperature
- If no time phase is active before 00:00, your rooms are heated to the reduced room temperature until the next time phase becomes active.

- DHW heating is active.
- The **"Holidays at home"** function starts and ends according to the set times for the start date and end date.

Note

- As long as the **"Holidays at home"** function is switched on, the default display shows **"Holidays at home"** and the set start date and end date.
- If **"Detached house"** was selected by your contractor during commissioning, the function is adopted for all heating/cooling circuits.

Example:

For Monday and Tuesday, 2 time phases are set respectively.

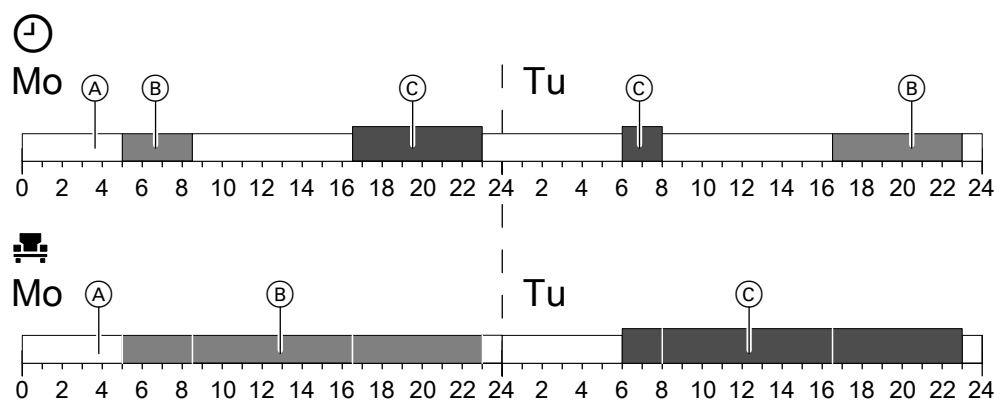



Fig. 10

⊙ Temperature level according to the set time program

 Temperature level if **"Holidays at home"** is switched on.

(A) Reduced room temperature

(B) Standard room temperature

(C) Comfort room temperature

Switching on "Holidays at home"

Tap the following buttons:

1. 

2.  "Holidays at home"

3.  for the required heating/cooling circuit

4.  for "Start" and "End"

5.  to confirm

Switching off "Holidays at home"

Tap the following buttons:

1. 

2.  "Holidays at home"

3.  for the required heating/cooling circuit

4. 

Saving energy during long periods of absence

To save energy during long periods of absence, select **"Holiday program"** .

Saving energy during long periods of absence (cont.)

The holiday program has the following effects:

- **Room heating:**
 - For heating/cooling circuits in the ☰ "Heating" operating program:
The rooms are heated to the set reduced room temperature.
 - For heating/cooling circuits in the ⏻ "Standby mode" operating program:
No room heating: Frost protection for the heat generator and the DHW cylinder is active.
- **Room cooling:**
 - For heating/cooling circuits in the ✳ "Cooling" operating program:
The rooms are cooled to the set reduced room temperature.
 - For heating/cooling circuits in the ⏻ "Standby mode" operating program:
No room cooling
- **DHW heating:**
 - No DHW heating: Frost protection for the DHW cylinder is active.
 - The holiday program starts at 00:00 on the first day of your holiday and ends at 23:59 on the final day.

Note

- As long as the "Holiday program" function is switched on, the selected first and last day of the holiday are shown in the "Heating/cooling circuit" and "Holiday program" default display.
- If "Detached house" was selected by your contractor during commissioning, the holiday program is switched on for all heating/cooling circuits.
- If "Apartment building" was selected by your contractor during commissioning, DHW heating will only be switched off if all heating/cooling circuits are in the holiday program.

Switching on the "Holiday program"

Tap the following buttons:

1. 
2.  "Holiday program"
3.  for the required heating/cooling circuit
4.  for "First holiday" and "Last holiday"
5.  to confirm

Switching off the "Holiday program"

Tap the following buttons:

1. 
2.  "Holiday program"
3.  for the required heating/cooling circuit
4. 

DHW heating

DHW temperature

Your DHW is always heated to the required temperature according to a set time program.

Factory settings: 50 °C

Note

For reasons of good hygiene, you should not set the DHW temperature lower than 50 °C.

Tap the following buttons:

1.  for the "DHW" default display

Set the time program for DHW heating: See page 30.



2.  for the required value



3.  to confirm

Switching DHW heating on/off (operating program)

If you switch off the DHW heating, no DHW can be heated, even using the "One-off DHW heating outside the time program" function.

Tap the following buttons:

1.  for the "DHW" default display
2. Highlighted button 

3.  "ON" if you want to **start** DHW heating.
 "OFF" if you want to **stop** DHW heating.

For information on the operating program: See page 19.





Time program for DHW heating

Setting a time program



In the time program for DHW heating, you set the time phases in which your DHW is heated and to what temperatures.

Factory setting: **One** time phase from 05:30 to 22:00 for every day of the week.

You can change the time program **individually** in accordance with your requirements.

5. Depending on the required change:
 for changing the beginning and end of the selected time phase
 for a new time phase
 to delete a time phase.
 to select the time phase if more than one time phase is set.

Tap the following buttons:

1.  for the "DHW" default display
2. 
3. Required day of the week
4. 

Note

- The DHW is not heated between the time phases. Frost protection for the DHW cylinder is enabled.
- When setting time programs, bear in mind that your system requires some time to heat the DHW cylinder to the required temperature.

For how to set a time program: See page 26.

Setting the time program for the DHW circulation pump

In the time program for the DHW circulation pump, you set the time phases in which the circulation pump runs constantly or at intervals.

At the factory, **no** time phases for the DHW circulation pump are set, i.e. the DHW circulation pump is switched off.

You can change the time program **individually** in accordance with your requirements.

Tap the following buttons:

1. 

Time program for DHW heating (cont.)

2.  "DHW"
3. 
4. Select a day of the week.
5. 
6. Depending on the required change:
 -   to change the time phase
 -  for a new time phase
 -  to delete a time phase.
 -   to select the time phase if more than one time phase is set.

For how to set a time program: See page 19.





"One-off DHW heating" outside the time program

If you require hot water outside the set time phases, switch on "Once-only DHW heating" . The DHW cylinder is heated once to the set DHW temperature.

This function has a higher priority than other functions, such as the time program for example.

Switching on "One-off DHW heating"

Tap the following buttons:



1.   for the "DHW" default display or possibly "Favourites"
2. 
3.  to confirm

Switching off "One-off DHW heating"

One-off DHW heating  ends as soon as the DHW set temperature has been reached.

2. 

Tap the following on-screen buttons to terminate "One-off DHW heating" early:

1.   for the "DHW" default display or possibly "Favourites"

Increased DHW hygiene

You can heat the water in the DHW cylinder to above 60 °C once a week or for an hour every day. This function is regularly carried out at the specified time.









Danger

High DHW temperatures can cause scalding, e.g. if the DHW temperature is above 60 °C. Mix with cold water at the draw-off points.

Switching on increased DHW hygiene

Tap the following buttons:

1. 
2.  "DHW"
3.  "Hygiene function"
4.   for the starting time "Start"
5. Select the required day of the week or daily. The selection is highlighted.
6.  to confirm

Increased DHW hygiene (cont.)

Switching off increased DHW hygiene

Tap the following buttons:

1. 
2.  "DHW"
3.  "Hygiene function"
4. Deselect the day of the week or daily.
5.  to confirm

Switching DHW scald protection on/off

With the scald protection, you limit the DHW temperature in the DHW cylinder to a maximum of 60 °C.

Tap the following buttons:

1. 
2.  "DHW"
3. "Scald protection"
4. "On" or "Off"
5.  to confirm

Note

With scald protection switched off, a set DHW temperature of over 60 °C can be set. There is an increased risk of scalding!

Quieter operation





Setting the time program for quieter operation





In the time program for quieter operation, set the time phases in which the speed of the fan and, if required, of the compressor are limited.

To do so, select an operating status for each time phase: See chapter "Operating status for quieter operation".

Factory setting: **No** time phase from 00:00 to 24:00 h for every day of the week. The fan speed is not limited.

Tap the following buttons:

1. 
2.  "Advanced"
3.  "Quieter operation"
4.  "Time program"

5. Set the required time phases and operating status.
 -  to change the time phase
 -  for a new time phase
 -  to delete a time phase.
 -  to select the time phase if more than one time phase is set.

Note

- *The fan speed is not limited between the set time phases.*
- *If your heating contractor has blocked the quieter operation setting, "**Cannot be changed**" is shown for 4 s. Your contractor can unlock the controls. You can check a time program set by the contractor for quieter operation under "**Information**".*

For how to set a time program: See page 19.

Operating status for quieter operation





You can choose between 2 operating statuses:

- **"Slight"**
The max. fan speed and, if required, that of the compressor are reduced by a small amount.
- **"Significant"**
The max. fan speed and, if required, that of the compressor are reduced by a large amount.

Switching emergency mode on/off

In emergency mode, the outdoor unit is switched off. The room heating and DHW heating is done by instantaneous heating water heater built into the indoor unit. In emergency mode, room cooling is switched off.

Tap the following buttons:

1. 
2.  "Advanced"
3. 
4.  Emergency mode "ON"
or
 Emergency mode "OFF"

Further adjustments





Disabling operation

You can lock the controls in 2 steps:

- Stage 1
- All functions on the default displays are operable. Message lists are displayed.
 - All other functions are disabled.

Stage 2 All functions are disabled.

Tap the following buttons:

1. 
2.  "Settings"
3.  "Disable operation"
4.  "Lock everything"
Or
 "Only home screen operable"

5. Enter the password: See chapter "Changing the password for the Lock panel function".

Note

The factory-set password is "viessmann". The password can be changed.



6.  to confirm

The password can be changed: See page 34.

Unlocking the controls





Tap the following on-screen buttons:

1. Any on-screen button
"Panel locked" is displayed.
2. 
"Do you want to unlock the operation?" is displayed.

3. 
An entry field and keyboard appear.
4. Enter the password "viessmann" or the password you have specified.
5.  to confirm

Changing the password for the "Lock panel" function



Tap the following on-screen buttons:

1. 
2.  "Settings"
3.  "Change password"
4. Enter the current password.
5.  to confirm

6. Enter the new password (1 to 20 characters).

Note



You will not be required to confirm the new password.





7.  to confirm
Information is displayed.
8.  to confirm the note

Setting the display brightness

You can adjust the display brightness for operation and for standby separately.

Tap the following buttons:

1. 
2.  "Settings"
3.  "Display setting"

4.  "Brightness, operation"
Or
 "Brightness, standby"
5.  for the required value
6.  to confirm

Switching the Lightguide on and off

Dependent upon the design of the heat generator, at the lower or upper edge of the control unit, a Lightguide is displayed.
With various displays, the Lightguide explains the functions of the control unit.



Meaning of the display:

- Lightguide pulsates slowly:
Display is in standby mode.
- Lightguide is illuminated constantly:
You are operating the control unit. Every input operation is confirmed by a brief flashing.
- Lightguide flashes quickly:
There is a fault in the system.

In the delivered condition, the Lightguide is switched on. You can switch off the Lightguide.

Tap the following buttons:

1. 

2.  "Settings"
3.  "Display setting"
4. "Lightguide ON/OFF"
5. "ON"
Or
 "OFF"
6.  to confirm

Note



Faults are shown by flashing lights even if the Lightguide is switched off.

Adjusting the signal tone for on-screen buttons

In the delivered condition, an audio signal is enabled to produce a sound when a button is tapped on the display. You can switch this audio signal on or off.

Tap the following buttons:

1. 
2.  "Settings"

3.  "Buzzer"
4. "ON"
Or
 "OFF"
5.  to confirm

Naming heating/cooling circuits



You can name all heating/cooling circuits individually, e.g. "Ground floor".
These names are used in the default displays and in the main menu.

Note

The abbreviations 1, 2, 3, 4 will be retained in the default display.

Tap the following buttons:

1. 
2.  "Settings"

3.  "Rename heating/cooling circuit"
4. Select the required heating/cooling circuit, e.g.  "Heating/cooling circuit 1"
5. Type in the required name, e.g. "Ground floor" (1 to 20 characters).
6.  to confirm



The name assigned to the relevant heating/cooling circuit is shown in the default display and in the main menu.

Further adjustments

Setting the "Time" and "Date"

The "Time" and "Date" are set at the factory. If your system has been shut down for a prolonged period, you may need to reset the "Time" and "Date".

Tap the following buttons:

1. 
2.  "Settings"
3.  "Date and time"
4.  "Date"
Or
 "Time"
5.   for the required value
6.  to confirm

Automatic "Summer/wintertime" changeover

The automatic changeover from summer/wintertime is factory-set.
In this menu you can switch the changeover from summer/wintertime on and off.

Tap the following buttons:

1. 
2.  "Settings"
3.  "Date and time"
4. "Time changeover"
5.   for "ON" or "OFF"
6.  to confirm

Setting the "Language"

Your contractor will have set the display language during commissioning. You can change the language.

Tap the following on-screen buttons:

1. 
2.  "Settings"
3.  "Language"
4. Required language
5.  to confirm

Setting "Units"

You can adjust all available units, e.g. for the temperature, date, pressure, etc.



Tap the following buttons:

1. 
2.  "Settings"
3.  "Units"
4. Select e.g. °C for the temperature.
5.  to confirm

Entering the contractor's contact details

You can enter your contractor's contact details. These can then be called up in the  "Information" menu.

Tap the following on-screen buttons:

1. 
2.  "Information"
3.  "Contractor contact details"
4. Relevant entry field

Entering the contractor's contact details (cont.)

5. Enter your contractor's contact details into the individual boxes.
6. ✓ to confirm

Setting the home screen

You can choose from the following default displays as your home screen:

- "Indoor environment"
- "DHW"
- "System overview"
- "Energy cockpit"
- "Favourites"

Tap the following on-screen buttons:

1. ☰

2. ⚙️ "Settings"
3. 🏠 "Selecting the default display"
4. Required display
5. ✓ to confirm

Note

Tap on 🏠 to call up the selected home screen.

Switching internet access on or off

You can control your system remotely via the internet using an app. To do this, establish an internet connection via WiFi (2.4 gigahertz): See the following chapter. The required credentials for internet access to the control unit via app can be found on the adjacent label:



Switching WiFi on/off

Tap the following buttons:

1. ☰
2. ⚙️ "Settings"
3. 📶 "Internet"
4. "WiFi operation mode"
5. ⚡ "OFF" if you want to **switch off** the WiFi.
Or
📶 "Internet" if you want to **switch on** the WiFi.
6. ✓ to confirm

Establishing a WiFi connection

Prerequisite: WiFi is switched on.

Tap the following buttons:

1. ☰
2. ⚙️ "Settings"
3. 📶 "Internet"
4. "Network selection"
 - Available WiFi networks are displayed.

Note

If a connection already exists, "**Connected**" is shown for the relevant network.



 - If you want to use an invisible WiFi network: Tap on 📶 and enter the name of WiFi (SSID) and the password.
5. Select WiFi.

Note

Use 🔄 to refresh the list of available WiFi networks.

Further adjustments

Switching internet access on or off (cont.)

6. ✓ to confirm
7. If your selected WiFi is not protected 
✓ to acknowledge the connection message
Or
If your selected WiFi is protected 
Enter the password of the protected WiFi (maximum 40 characters).
✓ to confirm
8. ✓ to acknowledge the information regarding internet use
The default display shows .



Note

- If the connection was not established, an error message is shown.
- An internet connection exists if the selected WiFi is connected to the internet. Check your WiFi settings if required.

Static IP addressing

Prerequisite: Your WiFi is configured so that the subscriber addresses in the network (IP addresses) are not automatically assigned.

Tap the following buttons:

1. 
2.  "Settings"
3.  "Internet"
4. "Network selection"
5. Available WiFi networks are displayed.

Note

Use  to refresh the list of available WiFi networks.

6. Select the network.

7. 
8. "STATIC" for static IP addressing
9. ✓ to confirm

10. Enter network data:
 - IP address
 - Subnet mask
 - Standard gateway
 - Primary DNS server
 - Secondary DNS server

11. ✓ to confirm

Note

An internet connection only exists if the selected WiFi is connected to the internet. Check your WiFi settings if required.



Switching off the display screen for cleaning

If you want to clean the display screen, you can deactivate it for 30 seconds. This prevents unintentional operation.

Clean the display with a microfibre cloth.

Tap the following on-screen buttons:

1. 

2.  "Settings"
3.  "Clean screen"
The display is deactivated. A countdown begins.

Restoring factory settings

You can reset all entries and values to their factory settings.

Note

If the heating or cooling circuits have been named, the assigned name is maintained. See chapter "Setting names for heating/cooling circuits".

Restoring factory settings (cont.)

System setting	Settings and values that are reset
"System"	Time program for quieter operation
"DHW"	<ul style="list-style-type: none"> ▪ DHW temperature ▪ Time program for DHW heating ▪ Time program for DHW circulation pump
"Heating/cooling circuit 1" "Heating/cooling circuit 2" "Heating/cooling circuit 3" "Heating/cooling circuit 4"	<ul style="list-style-type: none"> ▪ Reduced room temperature ▪ Standard room temperature ▪ Comfort room temperature ▪ Time program for room heating ▪ Heating curve slope and level ▪ Comfort and energy saving functions ("Extend time phase once", "Holidays at home", "Holiday program") are switched off.

Tap the following buttons:

1. 
2.  "Settings"
3.  "Factory settings"
4.  to confirm

Checks

Calling up help messages

You can call up help messages relating to the displays and functions.

Tap the following on-screen buttons:











1.  to call up the help messages.



2.  to return to the previous screen.

Checking information

Depending on the system equipment level and the settings made, you can check current system data, e.g. temperatures.

The system data is divided into the following groups:

-  General
-  Heat generator
-  DHW
-  Climate circuit 1
-  Climate circuit 2
etc.
-  Heating circuit 1
-  Heating circuit 2
etc.
-  Cooling circuit 1
-  Cooling circuit 2
etc.
-  Contractor contact details



-  Internet
-  Open source licence
Calls up the licence for the programming unit.

Note

If the heating/cooling circuits have been named, the assigned name is displayed: See chapter "Setting names for heating/cooling circuits".

Detailed options for checking the individual groups can be found in chapter "Menu overview".

Tap the following buttons:



1. 
2.  "Information"
3. Required group

Calling up licence information for the programming unit

You can call up the licence for the programming unit via the main menu.

Tap the following buttons:

1. 

2.  "Information"
3.  Open source licence

Calling up licence information for the integral communication module TCU201





Calling up licence information for the TCU201 communications module requires a WiFi-enabled mobile device, e.g. a smartphone or a PC.

Turn on the heat pump's "access point" to call up legal information saved locally in the heat pump control unit e.g. licences of "third party components".

Switching on access point

Tap the following buttons:

1. 

2.  "Settings"
3.  "Internet"
4. "WiFi operation mode"
5.  "Access point"
6.  to confirm

Calling up licence information for the integral... (cont.)

Calling up the license information for third party components

Requirement: Access point must be switched on.

Tap the following buttons:

1. Call up the WiFi settings on your mobile device.
2. Connect your mobile device to the WiFi "**Viessmann-<xxxx>**".
A password prompt will be displayed.
3. Enter the WPA2 network key as the password for the "**Viessmann-<xxxx>**" WiFi.

Note

The WPA2 network key can be found on the label:
See chapter "Switching internet access on or off".

4. With your connected mobile device, open **http://192.168.0.1** in your internet browser.
5. Follow the link "**Third party Components Licences**".

Third party software

1 Overview

This product contains third party software, including open source software. You are authorised to use this third party software subject to compliance with the relevant licensing terms as provided in this document. A list of used third party software components and of license texts can be accessed by connecting your boiler, like it is mentioned in the manual.

2 Acknowledgements

Linux® is the registered trademark of Linus Torvalds in the U.S. and other countries. This product includes software developed by the OpenSSL Project for use in the OpenSSL Toolkit (<http://www.openssl.org/>). This product includes cryptographic software written by Eric Young (eay@cryptsoft.com) and software written by Tim Hudson (tjh@cryptsoft.com).

3 Disclaimer

The open source software contained in this product is distributed WITHOUT ANY WARRANTY; without even the implied warranty of MERCHANTABILITY or FITNESS FOR A PARTICULAR PURPOSE. The single licences may contain more details on a limitation of warranty or liability.

4 How to obtain the source code

The software included in this product may contain copyrighted software that is licensed under a licence requiring us to provide the source code of that software, such as the GPL or LGPL. To obtain the complete corresponding source code for such copyrighted software, please contact us via the contact information provided in section 5 below indicating the build number you will find in the licensing information section, which can be accessed as outlined in this document. This offer is not limited in time and is valid to anyone in receipt of this information.

Calling up licence information for the integral... (cont.)

5 Contact information

Viessmann Climate Solution SE
D-35108 Allendorf
Germany
Fax +49 64 52 70-27 80
Phone +49 64 52 70-0
open-source-software-support@viessmann.com
www.viessmann.de

Calling up licence information for the integral communication module TCU300

Calling up the licence information requires a WiFi-enabled mobile device, e.g. a smartphone or a PC. Carry out the following steps:

1. Connect the heat pump to the WiFi router: See page 37.
2. Call up the IP address assigned to the heat pump in the WiFi network: See following chapter "Calling up the heat pump IP address".
3. Connect your mobile device to the same WiFi network as the heat pump.
4. In your device's internet browser, enter the heat pump IP address determined in step 2. The required licence information is displayed.

Calling up the heat pump IP address

Tap the following buttons:

1. 
2.  "Information"
3.  Internet

Screed drying

For screed drying, e.g. in a new build, your contractor can activate the "**Screed drying**" function. The screed will be dried in line with a set time program suitable for the building material (temperature:time profile).

- Room heating for all heating/cooling circuits takes place according to a set time program. Your settings for room heating/room cooling have no effect for the duration of screed drying.
- DHW heating is active.

Calling up screed drying for all heating/cooling circuits

Tap the following buttons:

1. 
2.  "Information"
3. "Heating/cooling circuit 1" to "Heating/cooling circuit 4"
4. "Operating program"

Screed drying lasts up to 32 days. The value displayed for "**Screed drying days**" is the number of days remaining.

Checking service messages

Your contractor can set service intervals. When these service intervals are exceeded, a service message is displayed automatically: "**Service**" and 

If available, your heating contractor's contact details will be displayed.

Checking service messages (cont.)

Tap the following on-screen buttons:



flashes in the navigation area.

Calling up a service message

Tap the following buttons:

1. in the navigation area.
If fault messages are also present in your system, they and any further messages can be called up with "**Faults**", "**Service messages**".
2. "**Service messages**"
The service messages appear in a list.
3. Tapping on ? calls up information on the system's characteristics.
Tips on measures you can take yourself **before** notifying your contractor are displayed.
4. Make a note of the service message number. For example: **P.1 "Interval until the next service"**.
This enables the contractor to be better prepared and may save you unnecessary travelling costs.
5. Please notify your heating contractor.
6. for acknowledging a service.

Note

If the service cannot be carried out until a later date, the service message will be displayed again the following Monday.

Checking fault messages

If your system has developed faults, "**Fault**" and are displayed. The Lightguide flashes even when switched off: See chapter "Switching the Lightguide on and off".

Tap the following buttons:



flashes in the navigation area.

Calling up a fault message

Tap the following buttons:

1. in the navigation area.
If service messages are also present in your system, they and any further messages can be called up with "**Faults**", "**Service messages**".
2. "**Faults**"
The fault messages appear in a list.
3. Tapping on ? calls up information on the system's characteristics.
Tips on measures you can take yourself **before** notifying your contractor are displayed.
4. Make a note of the fault number and the cause of the fault. For example: **F.160 "Communication error CAN bus"**.
This enables the contractor to be better prepared and may save you unnecessary travelling costs.
5. Please notify your heating contractor.
6. to acknowledge the fault.



Danger

If faults are not rectified, they can have life threatening consequences.
Do not acknowledge fault messages several times in quick succession. Please notify your contractor if a fault occurs. Your contractor will be able to analyse the cause and rectify the fault.

Checking message lists

Tap the following on-screen buttons:





1. 
2.  "Message lists"
3. If the relevant messages are present:
 - "Status"
 - "Warnings"
 - "Information"
 - "Faults"
 - "Service messages"

Shutting down the heat pump

With frost protection

You have the options of switching off the individual heating/cooling circuits, or the complete system.

Tap the following buttons:

1. 
2.  "Switch on/off"
3. You wish to switch off the heating/cooling circuits individually: Tap  for "**Standby mode**".
You wish to switch off the DHW heating: Tap  for "**Off**".
You wish to switch off the entire system: Tap  for "**Off**".

Note

- All circulation pumps connected to the control unit are briefly started every 24 hours to prevent them from seizing up.
- The diverter valves are switched over at regular intervals.

Without frost protection monitoring (shutting down the system)

You wish to shut down the system without frost protection monitoring.

Turn off the ON/OFF switch: See chapter "Position of the ON/OFF switch".

- No room heating
- No room cooling
- No DHW heating
- Frost protection for the heat generator and the DHW cylinder is **not** enabled.

Note

- As they are not being supplied with power, the circulation pumps and diverter valves may seize up.
- If your system has been shut down for a prolonged period, you must reset the "**Time**" and "**Date**": See page 36.



Please note

If outside temperatures below 3 °C are expected, take appropriate measures to protect the heat pump and the heating system from frost. Contact your heating contractor.

Starting the heat pump

Turn on the ON/OFF switch: See chapter "Position of the ON/OFF switch".

- After a short while, the home screen is shown on the display.
 - The Lightguide is illuminated constantly.
- Your heat pump and remote control units (if available) are now ready for operation.

Position of the ON/OFF switch

Wall mounted indoor unit

ON/OFF switch  is located on the underside of the indoor unit.

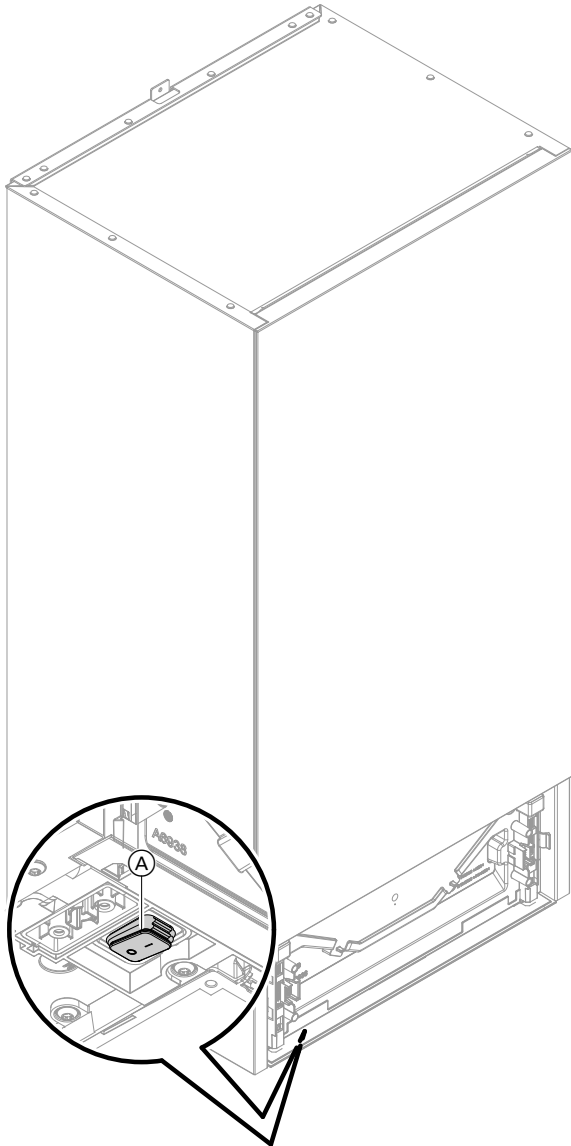

Fig. 11

Floorstanding indoor unit with integral DHW cylinder

Depending on the installation situation of the indoor unit, your contractor has installed the ON/OFF switch at position (A) (delivered condition) or (B).

Position of the ON/OFF switch (cont.)

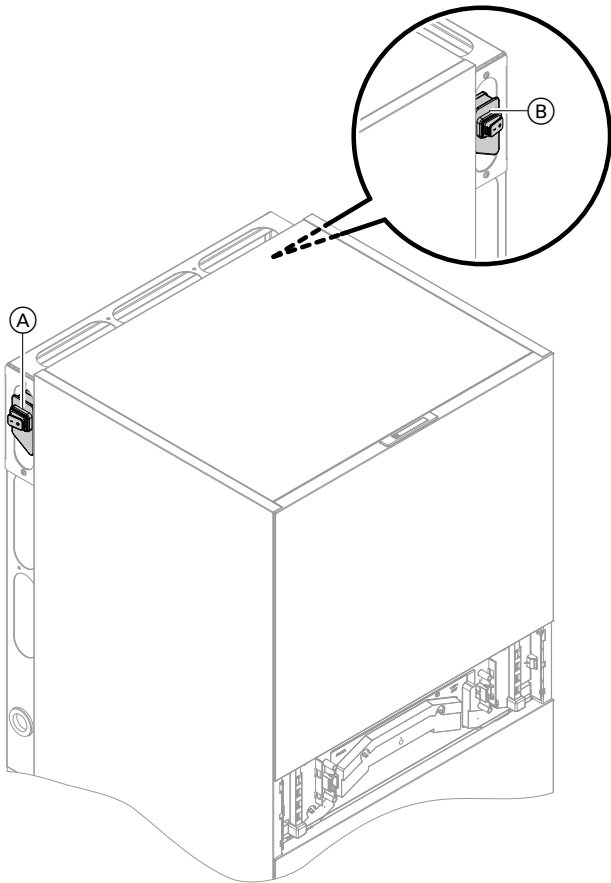

Fig. 12

What to do if...

Rooms are too cold

Cause	Remedy
The heat pump is switched off.	<ul style="list-style-type: none"> ▪ Reset the MCB in the power distribution board (main domestic MCB). ▪ Switch ON the mains isolator (if installed, outside the boiler room). ▪ Turn on the ON/OFF switch: See page 45.
Settings have been changed or are incorrect.	<p>Room heating must be switched on.</p> <p>Check the settings and correct if required:</p> <ul style="list-style-type: none"> ▪ Operating programs: See page 19. ▪ Room temperature: See page 25. ▪ Time: See page 36. ▪ Time program for room heating: See page 26. ▪ Heating curve: See page 26. ▪ The holiday program is switched on: See page 28.
The DHW cylinder is being heated.	<ul style="list-style-type: none"> ▪ Wait until the DHW cylinder has been heated up. ▪ Reduce the DHW draw-off rate or temporarily reduce the set DHW temperature if necessary.
"Status", "Warning", "Information", "Faults" or "Service messages" is shown on the display.	<ul style="list-style-type: none"> ▪ Check what type of fault it is. ▪ Make a note of the fault message and acknowledge the fault: See page 43. ▪ Please notify your heating contractor.
"Screed drying" is switched on.	<p>No action required.</p> <p>After expiry of the screed drying time, the selected operating program is switched on.</p>

Rooms are too hot

Cause	Remedy
Settings have been changed or are incorrect.	<p>Check the settings and correct if required:</p> <ul style="list-style-type: none"> ▪ Operating programs: See page 19. ▪ Room temperature: See page 25. ▪ Time: See page 36. ▪ Time program for room heating/room cooling: See page 26. ▪ Heating curve: See page 26. ▪ The "Holidays at home" function is switched on: See page 28.
"Status", "Warning", "Information", "Faults" or "Service messages" is shown on the display.	<ul style="list-style-type: none"> ▪ Check what type of fault it is. ▪ Make a note of the fault message and acknowledge the fault: See page 43. ▪ Please notify your heating contractor.
"Screed drying" is switched on	<p>No action required.</p> <p>After expiry of the screed drying time, the selected operating program is switched on.</p>

There is no hot water

Cause	Remedy
The heat pump is switched off.	<ul style="list-style-type: none"> ▪ Turn on the ON/OFF switch: See page 45. ▪ Switch on the mains isolator (outside the boiler room, if installed). ▪ Reset the MCB in the power distribution board (main domestic MCB).
Settings have been changed or are incorrect.	<p>DHW heating must be enabled.</p> <p>Check the settings and correct if required:</p> <ul style="list-style-type: none"> ▪ Operating program for DHW heating: See page 19. ▪ DHW temperature: See page 30. ▪ Time: See page 36. ▪ Time program for DHW heating: See page 30. ▪ The holiday program is switched on for all heating/cooling circuits: See page 28.
"Status", "Warning", "Information", "Faults" or "Service messages" is shown on the display.	<ul style="list-style-type: none"> ▪ Check what type of fault it is. ▪ Make a note of the fault message and acknowledge the fault: See page 43. ▪ Please notify your heating contractor.
"Screed drying" is switched on	<p>No action required.</p> <p>After expiry of the screed drying time, the selected operating program is switched on.</p>

The DHW is too hot

Cause	Remedy
Incorrect settings	Check and correct the set DHW temperature if required: See page 30.
The hygiene function is switched on.	Wait until the hygiene function has been completed.
DHW temperature for DHW heating is set too high at your solar PV system	Have your contractor change the setting at your solar PV system.

"Warning" is displayed

Cause	Remedy
Warning due to a specific event or operating state of the heat pump or heating system	Proceed as described on page 44.

"Fault" is displayed

Cause	Remedy
Heat pump or heating system fault	Proceed as described on page 43.

"External hook-up" is displayed

Cause	Remedy
The operating program selected at the heat pump control unit was changed over by an external switching device.	No action required

What to do if...

and "Service" are displayed

Cause	Remedy
The time for a service as specified by your contractor has arrived.	Proceed as described on page 42.

"Panel locked" is displayed

Cause	Remedy
The control panel is locked.	Unlock it: See page 34.

Cleaning

Clean the surface of the programming unit with a microfibre cloth.



Please note

- Commercially available domestic cleaning agents and special cleaning agents for the heat exchanger (evaporator) can damage the indoor and outdoor units.
 - Clean the appliance surfaces only with a damp cloth.
 - If necessary, clean the heat exchanger fins (evaporator) on the back of the outdoor unit only with a hand brush with long bristles.



Please note

- Commercially available cleaning agents can damage the surface of the external casing.
 - Use only mild water-based domestic cleaning agents.
 - Do **not** use substances containing acids or solvents, such as vinegar-based cleaners, nitro or synthetic resin solutions, nail varnish remover, ethyl alcohol, etc.



Please note

- Mechanical influence will scratch the surface of the external casing.
 - Only wipe the surface with a soft damp cloth.
 - Do **not** use substances that contain abrasive particles such as polishes, scouring agents, dirt erasers or scouring pads.
 - Do **not** clean the external casing with a pressure washer.

Inspection and maintenance

The inspection and maintenance of a heating system is prescribed by the German Buildings Energy Act and the DIN 4755, DVGW-TRGI 2018, DIN 1988-8 and EN 806 standards.

Regular maintenance ensures trouble-free, energy efficient, environmentally responsible and safe heating and cooling operation. For this, it is best to arrange an inspection and maintenance contract with your local heating contractor.

Note

Your outdoor unit contains highly flammable refrigerant of safety group A3. To ensure operational reliability over the entire service life of the heat pump, there are special requirements for inspection and maintenance. A special test of safety equipment is required after 12 years. Please contact your contractor.

DHW cylinder

Standards DIN 1988-8 and EN 806 specify that maintenance and cleaning should be carried out no later than 2 years after commissioning and as required thereafter.

Only a qualified contractor should clean the inside of the DHW cylinder and the DHW connections.

If any water treatment equipment (e.g. a sluice or injection system) is installed in the cold water supply of the DHW cylinder, ensure this is refilled in good time. For this, observe the manufacturer's instructions.

Safety valve (DHW cylinder)

The function of the safety valve must be checked every six months by the user or a contractor through venting (see valve manufacturer's instructions). The valve seat may become contaminated.

Water may drip from the safety valve during a heat-up process. The outlet is open to the atmosphere.



Please note

- Overpressure can cause damage. Do not close the safety valve.

Inspection and maintenance (cont.)

Potable water filter (if installed)

To maintain high hygienic standards, proceed as follows:

- Replace filter element on non-back flushing filters every six months (visual inspection every two months).
- On back flushing filters, back flush every two months.

Damaged cables / lines

If there is damage to the connecting cables or lines of the appliance or externally installed accessories, these must be replaced with special cables or lines. Only use Viessmann cables / lines as replacement. For this, notify your qualified contractor.

Overview of "Main menu"

Note

Depending on the features of your system, not all of the displays and checks listed may be available under



🔌 Switch on/off

🌡️ Climate circuit 1

🌡️ Climate circuit 2

🚰 DHW

🔌 Entire system

🏠 Indoor environment

🌡️ Climate circuit 1

Set room temperature or Set flow temperature

Time program heating

Heating curve

Additional heating/cooling circuits 🌡️, ...

As for 🌡️ heating/cooling circuit 1

🚰 DHW

🚰 Set DHW temperature

🕒 Time program, DHW

🕒 Time program, DHW circulation

🛡️ Hygiene function

Scald protection

⚙️ Settings

🗨️ Language

📺 Display setting

📅 Date and time

🔊 Buzzer

🔄 Rename climate circuits

🔧 Factory settings

📶 Internet

📶 Low power radio ON/OFF

🧼 Clean screen

🌡️ Units

🔒 Disable operation

🔒 Change password

🏠 Selecting the default display

Overview of "Main menu" (cont.)

 Information

 General

System pressure
Outside temperature
Flow temperature
Boiler circuit pump (primary circuit pump)
Thermal output
Screed drying
Four way valve position
Central fault message
Time
Date
Altitude
OEM product version

Heat generator

Flow temperature
Flow sensor
Electric booster heater
Quieter operation: <ul style="list-style-type: none"> ▪ Setting ▪ Time program
Smart Grid
Power-OFF
External blocking

Heating/cooling circuit 1

Operating program
Operating status
Time program
Set reduced room temperature
Set normal room temperature
Set comfort temperature
Heating curve slope
Heating curve level
Flow temperature
Holiday program
Holidays at home

Additional heating/cooling circuits *, ...
 DHW

Time program, DHW
Time program, DHW circulation
DHW temperature
DHW circulation pump

Overview of "Main menu" (cont.)

 Information

 Contractor contact details

 Internet

	Manufacturer's details
	MAC address
	Activated
	Network
	Signal strength
	DHCP activated
	IPv4 address
	IPv4 subnet mask
	Standard gateway
	Primary DNS server
	Secondary DNS server
	Backend connection
	Network connection

 Open source licence

 Holiday program
Note

This can be selected only if "Apartment building" was selected during commissioning and multiple heating/cooling circuits are installed.

 Select all

 Heating/cooling circuit 1

 Heating/cooling circuit 2

 etc.

 Holidays at home
Note

This can be selected only if "Apartment building" was selected during commissioning and multiple heating/cooling circuits are installed.

 Select all

 Heating/cooling circuit 1

 Heating/cooling circuit 2

 etc.

 Message lists

 Service

Overview of "Main menu" (cont.)

Advanced

 Noise reduction mode

 Emergency mode

Information on disposal

Disposal of packaging

Your contractor will dispose of the packaging from your Viessmann product.

Final decommissioning and disposal of the heating system

Viessmann products can be recycled. Components and fluids from your heating system do not belong in ordinary domestic waste. Please speak to your contractor about the correct disposal of your old system.

Keyword index

A	
Access point.....	12
Access point mode.....	40
Advanced settings.....	36
Ambient temperatures.....	13
B	
Brightness setting.....	34
Buffer cylinder	
– Factory settings.....	14
Button tone.....	35
C	
Calling up	
– Help messages.....	40
Call up	
– Screed drying.....	42
Check	
– Fault message.....	43
Checking.....	23
– Operating conditions, temperatures, information....	40
– Service message (maintenance message).....	42
Cleaning.....	38, 51
Cold rooms.....	48
Comfort (tips).....	15
Commissioning.....	14, 45
Communication modules.....	12
Contact details of heating contractor.....	36
Contractor.....	36
Controls.....	16
Cooling	
– Comfort.....	15
– Factory setting.....	14
Cooling circuit	
– Information.....	40
– Naming.....	35
D	
Date/time.....	14
Date setting.....	36
Day temperature (standard room temperature).....	25
Default display	
– DHW.....	22
– Energy cockpit.....	22
– Favourites.....	23
– Indoor environment.....	22
– System overview.....	24
Default display, permanent.....	37
Default setting.....	14
Delivered condition.....	14
DHW circulation pump	
– Energy saving.....	15
– Factory setting.....	14
– Time phases.....	30
– Time program.....	30
DHW heating.....	14
– Comfort.....	15
– Energy saving.....	15
– Information.....	40
– Operating program.....	19, 30
– Outside time program.....	31
– Time phases.....	30
– Time program.....	30
DHW hygiene.....	31
DHW temperature	
– Higher.....	31
– Setting.....	30
Display	
– Fault.....	49
– Warning.....	49
Display backlight.....	34
Display screen cleaning.....	38
E	
Emergency mode.....	33
Energy balance.....	23
Energy saving function	
– Holiday program.....	28
– In long periods of absence.....	28
Excess power.....	15
Extend time phase once	
– Switching off.....	27
– Switching on.....	27
External hook-up.....	19, 49
F	
Factory setting.....	14
Factory settings, restore.....	38
Fault.....	49
Fault message	
– Acknowledging.....	43
– Checking.....	43
Favourites.....	23
Favourites compilation.....	23
Flow temperature.....	25
Frost protection.....	14
– Monitoring.....	45
Further settings.....	36
H	
Heat generator heating characteristics, changing.....	26
Heating	
– Comfort.....	15
– Factory setting.....	14
Heating/cooling circuit	
– Information.....	40
– Naming.....	35
Heating/cooling circuit selection.....	25
Heating curve.....	14
– Setting.....	26
Heating times setting.....	20
Heat pump	
– Starting.....	45
– Switching off.....	45
Heat pump control unit.....	12

Keyword index (cont.)

Help message call up.....	40	Operation, disabling.....	34
Higher DHW temperature.....	31	Outside temperature limits.....	13
Holiday program		P	
– Switching off.....	29	Panel locked.....	50
– Switching on.....	28, 29	Power failure.....	14
Holidays at home.....	15	Product information.....	12
– Switching off.....	28	Q	
– Switching on.....	28	Quieter operation.....	15
Home screen.....	16	– Operating status.....	33
Hygiene function		– Time phases.....	33
– Switching off.....	32	– Time program.....	33
– Switching on.....	31	R	
I		Remote control.....	12
Information.....	12	Reports.....	17
Information checking.....	40	Reset.....	38
Inspection.....	51	Room cooling	
Installation room.....	13	– Operating program.....	19
Internet access, switching on.....	37	– Switching off.....	25
L		– Switching on.....	25
Language selection.....	36	– Time phases.....	26
Legal information		– Time program.....	26
– Communication module.....	40, 42	Room heating	
– Programming unit.....	40	– Operating program.....	19
Level.....	26	– Switching off.....	25
Liability.....	10	– Switching on.....	25
Licences.....	13	– Time phases.....	26
– Communication module.....	40, 42	– Time program.....	26
– Operating unit.....	40	Room heating/room cooling	
Lightguide.....	16, 35	– Comfort.....	15
– Meaning.....	16	– Factory setting.....	14
Low power radio.....	13	Rooms	
M		– Too cold.....	48
Main menu.....	18	– Too warm.....	48
Maintenance.....	51	Room temperature	
Menu structure.....	53	– Adjusting for longer periods at home.....	28
Message lists.....	44	– Energy saving.....	14
Mobile phone network.....	12	– Factory setting.....	14
N		– Temporary adjustment.....	27
Name of heating/cooling circuits.....	35	S	
Network selection.....	37	Safety group.....	9, 13
No hot water.....	49	Safety zone.....	9, 13
Noise level.....	15	Screed drying.....	19, 42
O		Screensaver.....	16
ON/OFF switch.....	45	Service contract.....	51
One-off DHW heating		Service link.....	13
– Switching off.....	31	Service message.....	50
– Switching on.....	31	Service message (maintenance message).....	42
Open-source licences.....	40	Shutting down	
Operating conditions, checking.....	40	– Heat pump.....	45
Operating data.....	23	Shutting down system.....	45
Operating program		Signal tone, button.....	35
– Adjusting, standby mode heating/cooling.....	45	Slope.....	26
– Heating, cooling and DHW.....	19	Smart Grid.....	15
– Setting DHW.....	30	Standard heating mode.....	14
– Special.....	19	Standard setting.....	38
		Standby.....	16

Keyword index (cont.)

Standby mode.....	45	Time phase setting.....	20
Starting		Time program.....	15
– Heat pump.....	45	– Comfort.....	15
Static IP addressing.....	38	– DHW circulation pump.....	30
Status display.....	16	– DHW heating.....	30
Stopping		– Quieter operation.....	33
– Quieter operation.....	33	– Room heating/room cooling.....	26
Summer/wintertime, setting.....	36	– Setting.....	19
Summertime/wintertime changeover.....	14	Time program, copying.....	21
Switch DHW scald protection on/off.....	32	Time setting.....	36
Switching off		Tips	
– Heat pump.....	45	– Comfort.....	15
Switching on		– Energy saving.....	14
– Frost protection.....	45	Troubleshooting.....	48
T		Type plate.....	12
Temperature		U	
– Checking.....	40	Units, setting.....	36
– Standard room temperature.....	25	Utilisation.....	11
Temperature level setting.....	25	V	
Third-party components Licenses.....	40	Vacation.....	28
Time/date.....	14	W	
Time phase, extend		Warning.....	49
– Switching off.....	27	Water too cold.....	49
Time phase changing.....	21	Water too hot.....	49
Time phase deletion.....	21	WiFi connection.....	37
Time phase extending		WiFi network.....	37
– Switching on.....	27	WiFi router.....	12
Time phases		Wintertime/summertime changeover.....	14
– DHW circulation pump.....	30		
– DHW heating.....	30		
– Quieter operation.....	33		
– Room heating/room cooling.....	26		

Certification

RoHS
compliant
2011 / 65 / EU

Your contact

Contact your local contractor if you have any questions about your system or wish to arrange maintenance or repair work. You can find local contractors on the internet at www.viessmann.de.



Viessmann Climate Solutions SE
35108 Allendorf / Germany
Telephone: +49 6452 70-0
Fax: +49 6452 70-2780
www.viessmann.com

Viessmann Limited
Hortonwood 30, Telford
Shropshire, TF1 7YP, GB
Telephone: +44 1952 675000
Fax: +44 1952 675040
E-mail: info-uk@viessmann.com

6171827 Subject to technical modifications.