

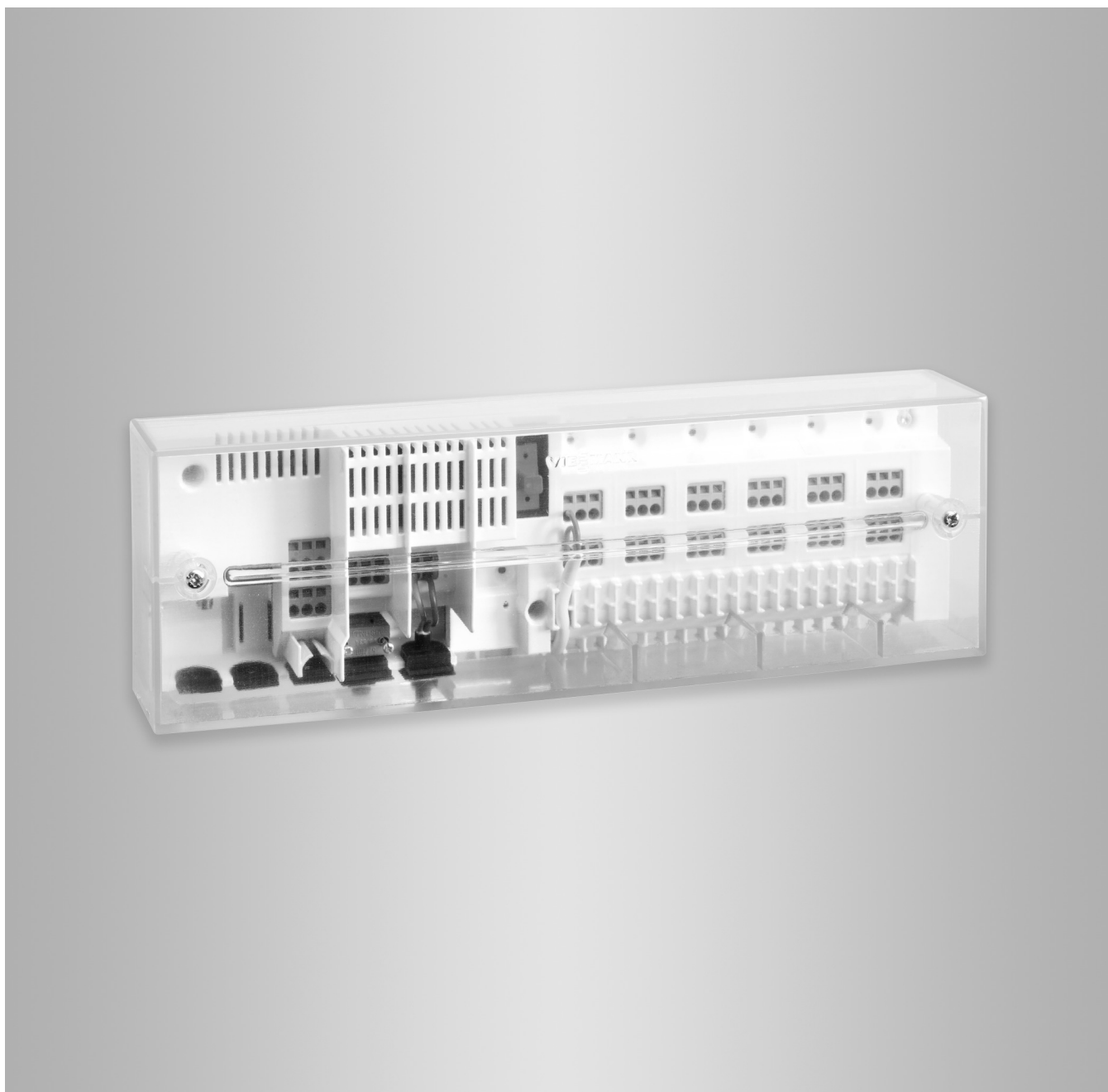

ViCare floor thermostat

ViCare floor thermostat



Safety instructions

-  Please follow these safety instructions closely to prevent accidents and material losses.

Safety instructions explained

-  **Danger**
This symbol warns against the risk of injury.

-  **Please note**
This symbol warns against the risk of material losses and environmental pollution.

Note
Details identified by the word "Note" contain additional information.

Target group

These instructions are intended for system users.

Individual sections of these instructions describe activities to be carried out by contractors.

This appliance can also be operated by children aged 8 and older, as well as by individuals with reduced physical, sensory or mental faculties or those lacking in experience and knowledge, provided such individuals are supervised or have been instructed in the safe use of this appliance and any risks arising from it.

-  **Danger**
Wireless signals can interfere with electronic medical devices, particularly pacemakers, hearing aids and defibrillators.
If any such equipment is fitted, users should avoid being in the immediate vicinity of operational wireless components.

Installation and adjustment

- All settings and work on the device must be carried out as specified in these instructions.
- Work on electrical equipment may only be carried out by a qualified electrician.
- Always connect devices at correctly installed sockets.
- When working on the device, disconnect the mains plug.
- Observe minimum clearances to ensure reliable signal transmission.

Operation of the system

- Only ever operate devices in dry, frost-free indoor rooms (not bathrooms).
- Never operate devices in rooms where there is a risk of explosion.

Safety instructions (cont.)

- Protect devices from:
 - Moisture
 - Dust
 - Liquids
 - Vapours
 - Direct insolation
 - Other direct thermal radiation
- After a power failure or restart, check the status of the wireless components.
- Never touch the power supply unit/ power cable with wet hands.

**Danger**

Damaged equipment poses a safety hazard. Check the appliance for external damage. Never start up a damaged appliance.





Auxiliary components and individual parts

For replacement, use only spare parts supplied or approved by Viessmann.

**Danger**

Connecting unsuitable power supply units/power cables poses a fire risk. Only connect the power supply unit/ power cable provided.

Index

1. Safety and liability	Operational reliability	5
	Liability	5
2. Introductory information	Disposal of packaging	6
	Symbols	6
	Contractors	6
	Intended use	6
	Product information	7
	■ Functions	7
	■ Current information about the ViCare floor thermostat	8
	■ Maintenance parts and spare parts	8
	■ Data connections	8
	Operation via app	10
3. Preparing for installation	Installation location	11
	■ Wireless signal range	11
	■ Angle of penetration	11
4. Installation sequence	Overview of the installation and commissioning process	13
	Installing the ViCare floor thermostat	13
	■ Top-hat rail mounting	13
	■ Mounting on the wall	14
	Opening the enclosure	14
	 Overview of electrical connections	14
	 Connecting the control valves	15
	 Connecting the temperature sensor	16
	Connecting the antenna for low power radio	17
	 Connecting the power cable	17
5. Commissioning	Display and controls	18
	Inserting the power plug	20
	Pairing the ViCare floor thermostat	20
	Fitting the cover	21
6. Settings	Restoring factory settings	22
7. What to do if...	If there is a power failure	23
	If there is a connection fault to the heat generator with Viessmann One Base or Vitoconnect	23
	If excess temperatures occur	23
	If the LED of an actuator lights up red	23
	 If the actuator is faulty	23
	Frost protection	24
8. Maintenance	Software update	25
	Checking the contact temperature sensor	25
	Service	25
	Cleaning	25
9. Specification	26
10. Appendix	Final decommissioning and disposal of the heating system	27
11. Keyword index	28

Operational reliability

Do not use the ViCare floor thermostat in conjunction with the following devices:

- Devices which directly or indirectly serve health or life-saving purposes
- Devices which, when operated, may result in a risk to humans, animals or property



Please note

Operating the ViCare floor thermostat outside the indicated output limit can lead to appliance damage, electric shock or fire.

Only use the ViCare floor thermostat with consumer loads up to 230 V~, 3 A rated current (0.1 A per output).

Liability

No liability is accepted for loss of profit, unattained savings, or other direct or indirect consequential losses resulting from use of the ViCare floor thermostat, the Viessmann server or the software, or for damage resulting from inappropriate use.

Liability is limited to typical damage arising if a fundamental contractual obligation is violated through slight negligence, the fulfilment of which is essential for proper execution of the contract.

The limitation of liability shall not apply if the damage was caused deliberately or through gross negligence, or if mandatory liability applies due to product liability legislation.









The Viessmann General Terms and Conditions apply, which are included in each current Viessmann pricelist. Viessmann accepts no liability for push notifications and email services provided by network operators. The terms and conditions of the relevant network operators apply in this context.

Introductory information

Disposal of packaging

Please dispose of packaging waste in line with statutory regulations.

Symbols

Symbol	Meaning
	Reference to other document containing further information
	Step in a diagram: The numbers correspond to the order in which the steps are carried out.
	Warning of material losses and environmental pollution
	Live electrical area
	Pay particular attention.
	<ul style="list-style-type: none">Component must audibly click into place.orAcoustic signal
	<ul style="list-style-type: none">Fit new component.orIn conjunction with a tool: Clean the surface.
	Dispose of component correctly.
	Dispose of component at a suitable collection point. Do not dispose of component in domestic waste.

Contractors

 Activities that may only be carried out by the contractor are indicated with this symbol.

Work on electrical equipment may only be carried out by a qualified electrician.

Intended use

Install and operate the ViCare floor thermostat as intended, in conjunction with the electronic control units and controllers of the supported Viessmann heat and power generators. The ViCare floor thermostat can also be operated without connection to a heat generator.

In particular, observe the current and voltage specifications for connections and hook-ups.

Intended use (cont.)

The ViCare floor thermostat is designed exclusively for operation in residential or commercial buildings. Incorrect use of the device (e.g. commercial or industrial use other than for control purposes) is prohibited and will result in an exclusion of liability.

Installation, service and operating instructions included with the product and available online must be observed. Use the ViCare floor thermostat exclusively for monitoring, operating and optimising systems with the user interfaces and communication interfaces specified for this purpose in the relevant printed documentation. With regard to the communication interfaces, ensure on site that the system requirements specified in the product documentation are met at all times for every transfer medium employed.

Note

The device is intended exclusively for domestic or semi-domestic use, i.e. even users who have not had any instruction are able to operate the device safely.

Product information

The ViCare floor thermostat enables intelligent control of the underfloor heating system with up to 6 heating zones and 18 thermal actuators.

The ViCare floor thermostat and a heat generator with Viessmann One Base or Vitoconnect communicate via low power radio.

The ViCare floor thermostat can only be used in conjunction with:

- Heat generator with Viessmann One Base
Or
- Viessmann heat generator with Vitoconnect, e.g. type OPTO2
Or
- Vitoconnect, e.g. type OPTO2 without connection to a Viessmann heat generator

Functions

- The zones of the ViCare floor thermostat can be included in energy efficient and convenient individual room control.
 - Individual automatic time programs and manual operation can also be used in individual room control.
 - The ViCare floor thermostat has a switching contact for the heat demand or solenoid valve control.
 - In operation with the heat generator with Viessmann One Base or Vitoconnect, e.g. type OPTO2, the heat demand is automatically determined and optimally controlled.
- Note**
At least 1 temperature value from a ViCare climate sensor is required per heating circuit.
- The ViCare floor thermostat has an internal frost protection function that prevents the pipes from freezing. If the flow temperature falls below approx. 8 °C, the ViCare floor thermostat opens until the flow temperature is reached again.
 - Includes a function to protect the heating circuits if communication fails with the heat generator with Viessmann One Base or Vitoconnect, e.g. type OPTO2. The heat demand is activated and all valves are controlled with 10 %. When communication is resumed, the valves return to normal mode.
 - The ViCare floor thermostat is compatible for operation with 230 V "normally closed" thermal actuators (on site).
 - The ViCare floor thermostat is automatically deactivated by the heat generator with Viessmann One Base or Vitoconnect, e.g. type OPTO2, if the heat generator also interrupts heating operation. E.g. summer mode; only DHW mode is active.
 - To prevent the valves from sticking, the valve outputs are opened for 8 minutes every 30 days after they were last actuated.
 - The ViCare floor thermostat also functions as a low power radio repeater.

Current information about the ViCare floor thermostat

For a current overview of the supported appliances or updates for the product, e.g. information on commissioning: See www.vicare.info

Maintenance parts and spare parts

Maintenance parts and spare parts can be identified and ordered directly online.

Viessmann Partnership

Login:
<https://shop.viessmann.com/>



Viessmann spare part app

www.viessmann.com/etapp



Data connections

In conjunction with heat generator with Viessmann One Base

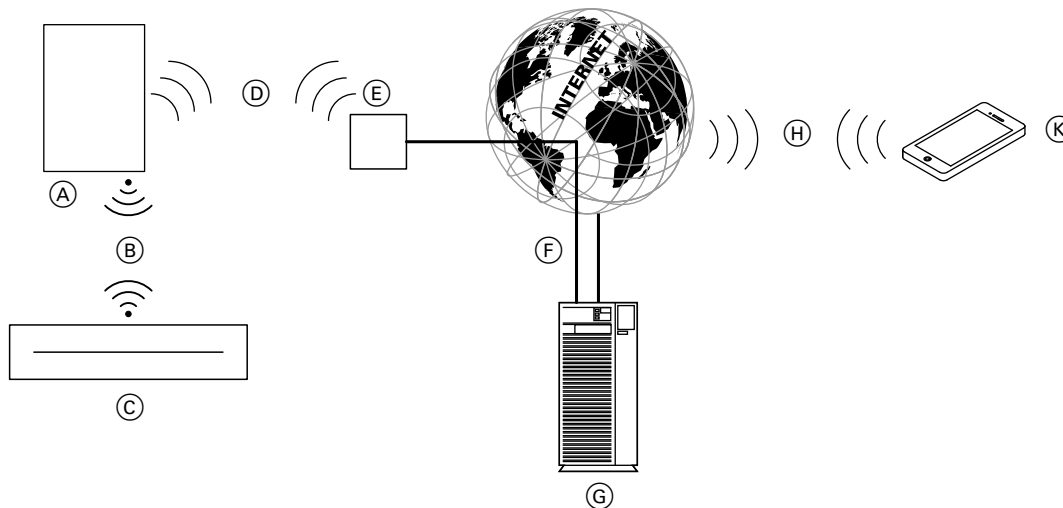

Fig. 1

- (A) Heat generator with Viessmann One Base
- (B) Low power radio
- (C) ViCare floor thermostat
- (D) WiFi
- (E) WiFi router (on site)
- (F) Secure internet connection to the Viessmann server
- (G) Viessmann server
- (H) Mobile network
or
WiFi connection
- (K) Mobile device

Product information (cont.)

In conjunction with Viessmann heat generator and Vitoconnect

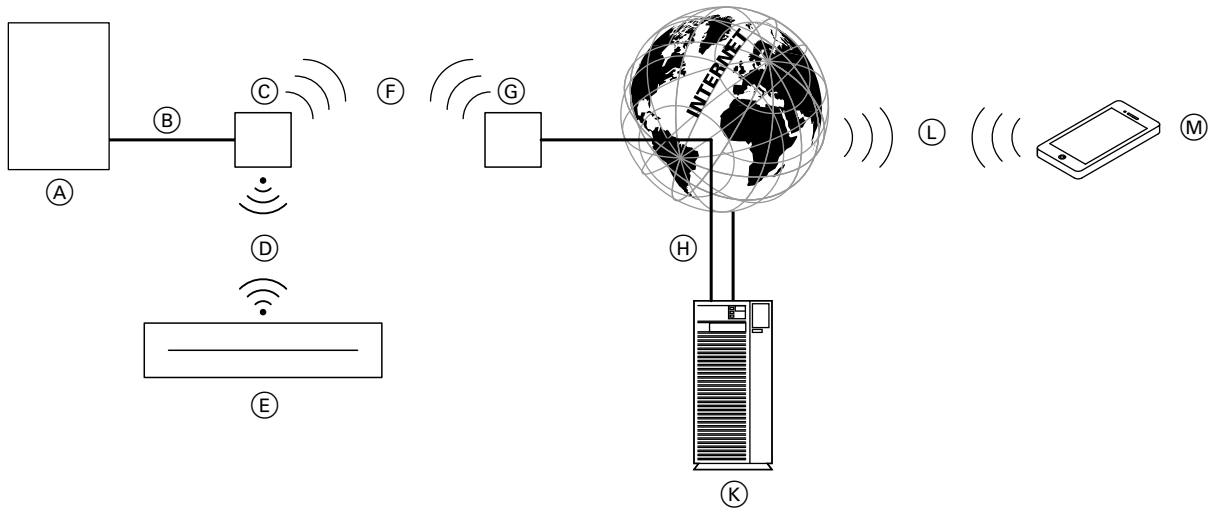

Fig. 2

- (A) Heat generator with control unit
- (B) Optolink connecting cable
- (C) Vitoconnect, e.g. type OPTO2
- (D) Low power radio
- (E) ViCare floor thermostat
- (F) WiFi
- (G) WiFi router (on site)
- (H) Secure internet connection to the Viessmann server
- (K) Viessmann server
- (L) Mobile network
or
WiFi connection
- (M) Mobile device

Without connection to a heat generator

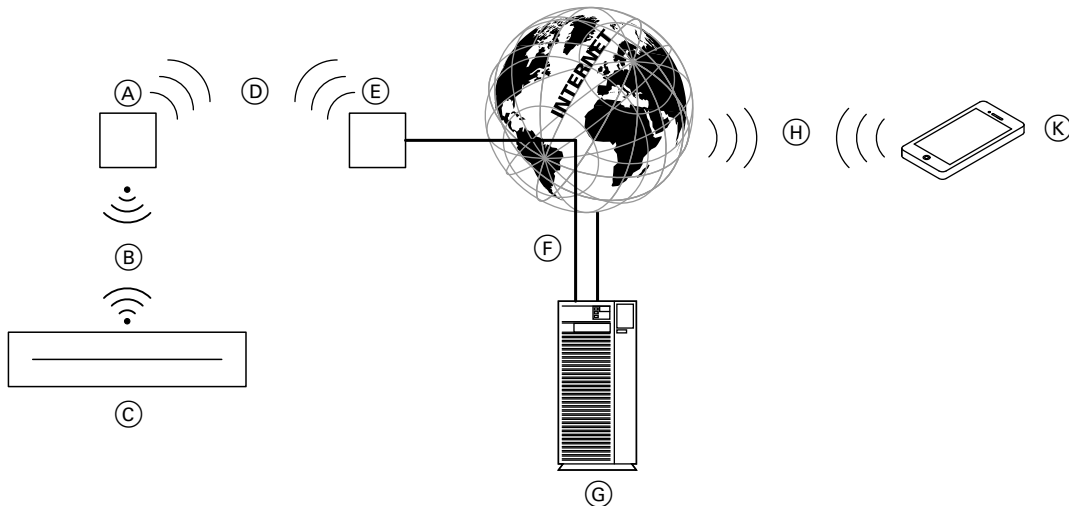

Fig. 3

- (A) Vitoconnect, e.g. type OPTO2
- (B) Low power radio
- (C) ViCare floor thermostat
- (D) WiFi
- (E) WiFi router (on site)
- (F) Secure internet connection to the Viessmann server
- (G) Viessmann server
- (H) Mobile network
or
WiFi connection
- (K) Mobile device

Product information (cont.)

Note

Please note that the compatibility of iOS and Android devices changes over time. It is essential to keep mobile devices updated and even to replace them if necessary.

Further information can be found on the internet at www.vicare.info

Operation via app

ViCare app

The system operator is able to control the heating system remotely via the internet using the ViCare app.



ViGuide

You can control the heating system remotely via the internet using ViGuide. To do so, the system operator must issue a once-only enable via the ViCare app. For further information: Visit www.vitoguide.info

Installation location

Installation type: Wall mounting or top-hat rail mounting

- Installation only in enclosed buildings
- The installation location must be dry and free of frost.

- Ensure ambient temperatures between +5 and +50 °C.
- Do not seal off the ventilation openings of the ViCare floor thermostat.

Wireless signal range

The range of wireless signals may be reduced by walls, ceilings and interior fixtures. These weaken the wireless signal.

Reception may be disturbed by the following conditions:

- On their way between transmitter and receiver, wireless signals are **damped**, e.g. by air or when penetrating walls.
- Wireless signals are **reflected** by metallic objects, e.g. reinforcements embedded in walls, metal foil of thermal insulation and thermal glazing with metalised thermal vapour deposit.
- Wireless signals are **isolated** by service ducts and lift shafts.
- Wireless signals are **disrupted** by devices that also operate with high frequency signals. Maintain a distance of **at least 2 m** from these devices:
 - Computers
 - Audio and video systems
 - Devices with active WiFi connection
 - Electronic transformers
 - Pre-ballasts

Note

- *Attach the supplied antenna in a position that will allow good radio transmission. **Not** inside the distribution box.*
- *If the reception quality is not sufficient, the wireless signal can be amplified by a Viessmann wireless repeater:*
 - *ViCare wireless repeater for surface mounting, accessories*
 - *Wireless repeater for flush mounting, accessories*

Angle of penetration

The reception quality remains best if wireless signals hit the walls vertically.

Depending on the angle of penetration, the effective wall thickness changes and so does the extent to which the electromagnetic waves are damped.

Flat (unfavourable) angle of penetration

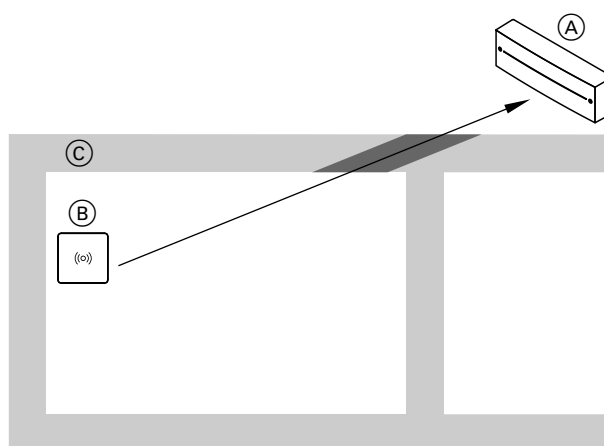

Fig. 4

- (A) ViCare floor thermostat
- (B) Heat generator with Viessmann One Base or Vitoconnect, e.g. type OPTO2
- (C) Wall

Preparing for installation

Installation location (cont.)

Ideal angle of penetration

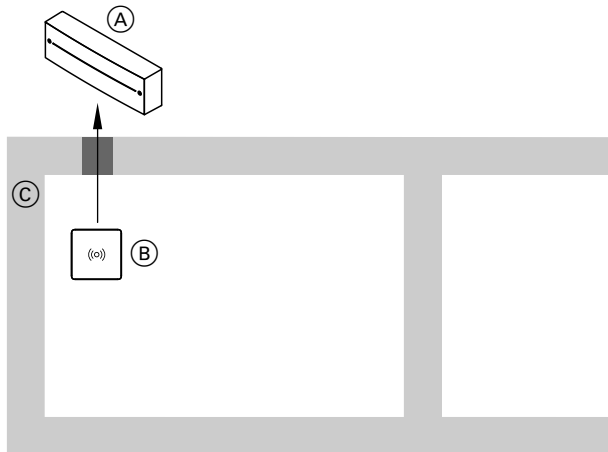

Fig. 5

- (A) ViCare floor thermostat
- (B) Heat generator with Viessmann One Base or Vitoconnect, e.g. type OPTO2
- (C) Wall

To increase the range, install an additional wireless repeater between the climate sensor located furthest away and the closest device or appliance (floor thermostat or heat generator).
The floor thermostat also works as a wireless repeater.

Increasing the range

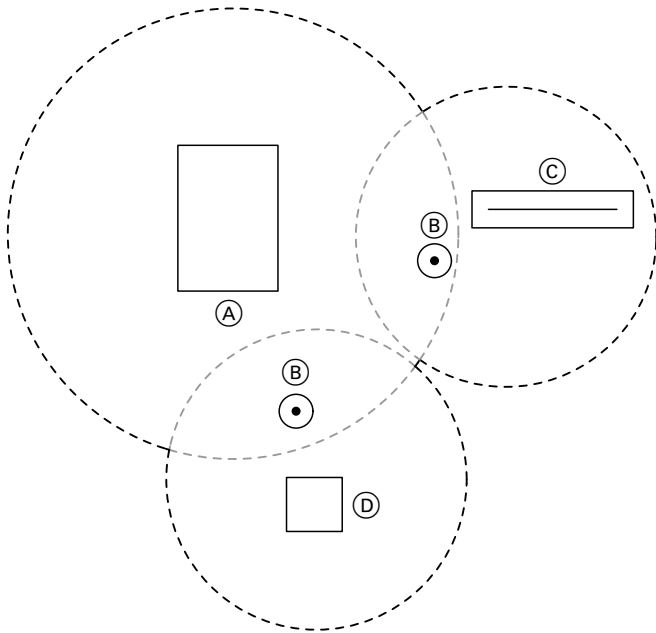





Fig. 6

- (A) Wireless or WiFi appliance, e.g. heat generator with One Base
- (B) Wireless repeater or WiFi repeater
- (C) ViCare floor thermostat
- (D) At the climate sensor located furthest away

Overview of the installation and commissioning process

Steps		Page
1	Install the ViCare floor thermostat.	13
2	 Connect the control valves.	15
3	 Connect the temperature sensor.	16
4	Connect the antenna for low power radio.	17
5	 Connect the power cable. Note <i>Do not yet insert the power plug.</i>	17
6	Insert the power plug.	20
7	Pair the ViCare floor thermostat.	20
8	Fit the cover.	21

Installing the ViCare floor thermostat

Top-hat rail mounting

In the heating circuit distributor, a free space measuring 310 x 100 x 66 mm is required for the floor thermostat.

Provide a suitably fused standard socket in the floor distributor for the power supply to the floor thermostat: See page 17.

The ViCare floor thermostat can be installed in a floor distributor enclosure on a 35 mm top-hat rail in accordance with EN 50022.

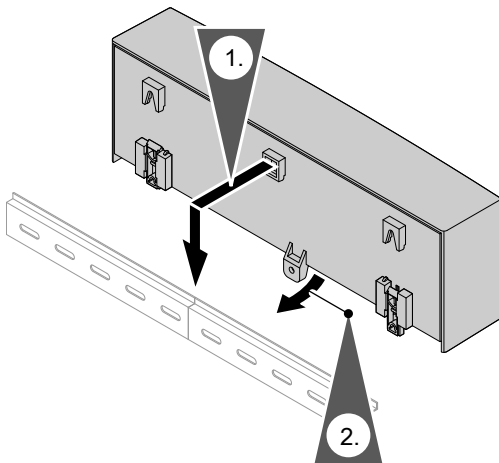

Fig. 7

Mounting on the wall

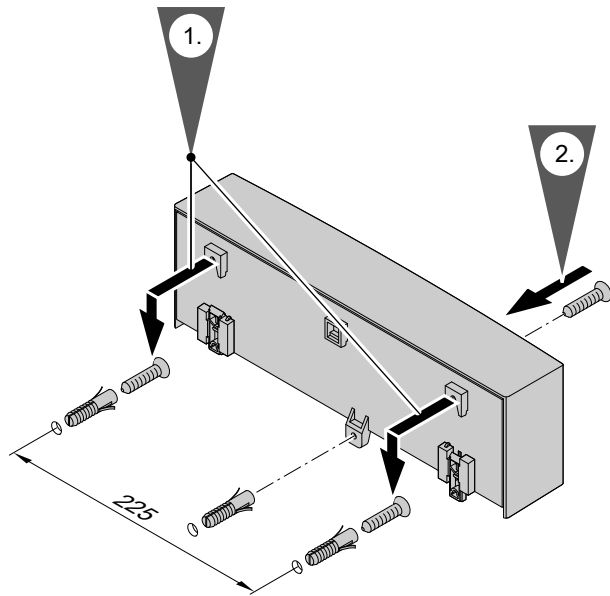

Fig. 8

Opening the enclosure

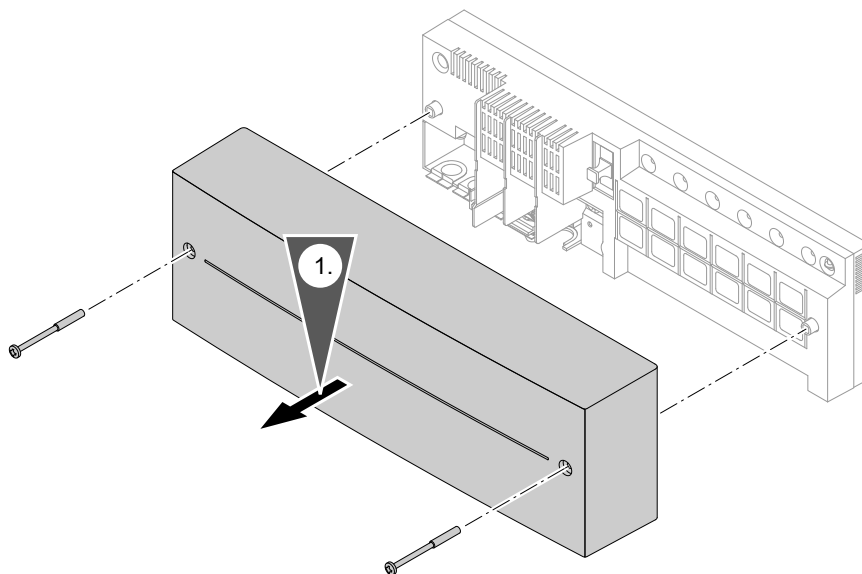

Fig. 9

 Overview of electrical connections

- ! **Please note**
Electrostatic charge can damage electronic assemblies.
Before beginning work, touch an earthed object, such as a heating or water pipe to discharge any static.



Overview of electrical connections (cont.)

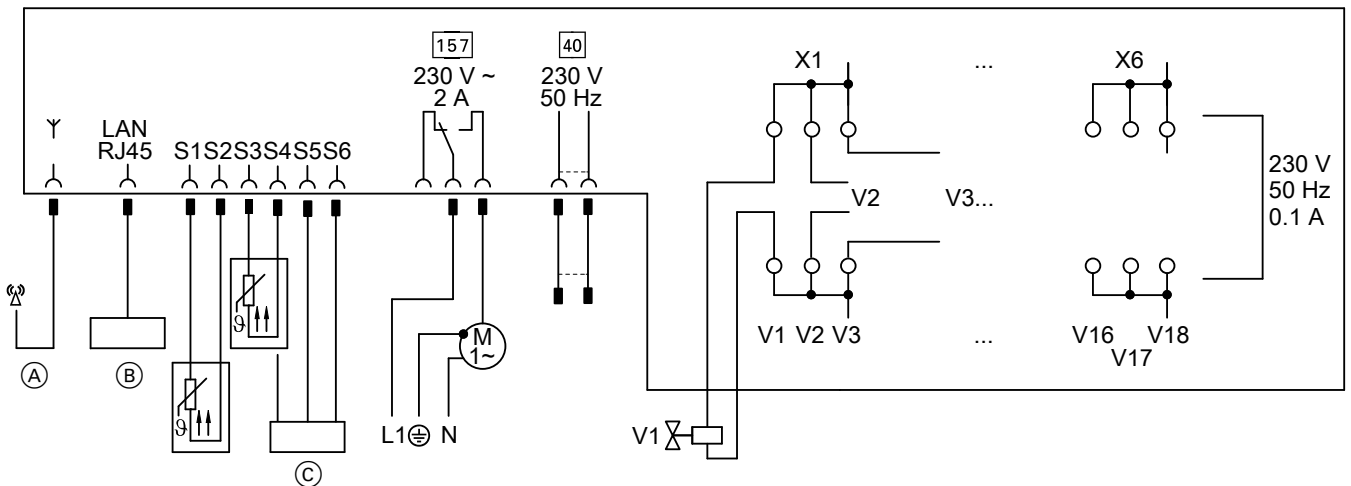

Fig. 10

- | | |
|---|--|
| <p>(A) End of antenna for low power radio</p> <p>(B) Only for servicing purposes:
LAN socket</p> <p>(C) 2 x contact temperature sensor and/or combined sensor (digital humidity/temperature sensor for heat pumps with cooling)
S1 Pt1000 +
S2 GND –
S3 Pt1000 + (optional)
S4 GND – (optional for combined sensor or Pt1000)
S5 VCC combined sensor, 5 V
S6 Combined sensor signal</p> | <p>157 Floating contact (solenoid valve control or heat demand)</p> <p>40 Power supply 230 V/50 Hz</p> <p>V1 to V18 Actuators of the control valves</p> <p>X1 to X6 Heating zones</p> <p>Note
Connection of 3 actuators per heating circuit.
Starting current per actuator: ≤ 1 A</p> |
|---|--|



Connecting the control valves

Danger
Incorrectly executed electrical installations can result in injuries from electrical current and appliance damage.
Work on electrical equipment may only be carried out by a qualified electrician.

Please note
Excessive starting currents can result in appliance damage.

- The maximum starting current of an actuator must not exceed 1 A.
- Connect a maximum of 3 actuators per heating zone.

Please note
Connecting actuators while the ViCare floor thermostat is switched on can result in appliance damage.
Disconnect the ViCare floor thermostat from the power supply beforehand.

Note
The ViCare floor thermostat is preset for operation with 230 V "normally closed" thermal actuators (on site). 230 V "normally open" or "normally closed" thermal actuators are compatible. If "normally open" actuators are installed, the settings in ViGuide need to be adjusted.

Note
The actuators for any one heating zone must be structurally identical. A mixture of "normally open" and "normally closed" valves within one heating zone is not possible.

Recommended actuators for the floor thermostat:

- Part no. 7750202
- Part no. 7784211

Installation sequence

Connecting the control valves (cont.)

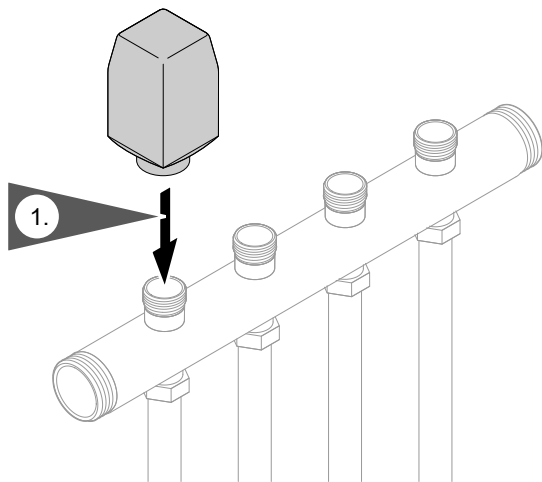

Fig. 11

1. Install the actuators on the heating circuit distributor.



Please note

If the floor thermostat is operated with the wrong type of actuator, the appliance may be damaged.

Only 230 V actuators may be connected to the floor thermostat.

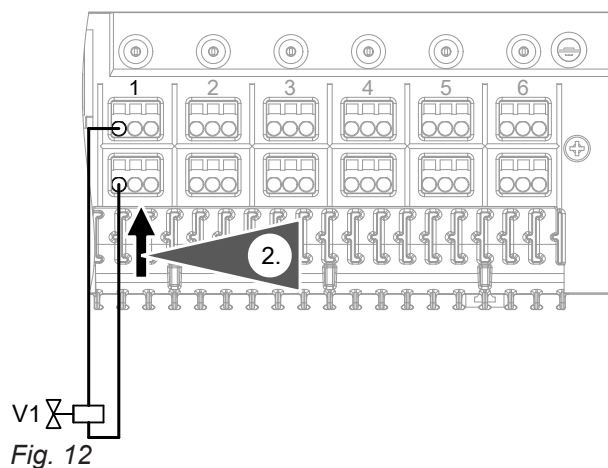

Fig. 12

2. Connect the actuators: See connection diagram on page 15.

Connecting the temperature sensor

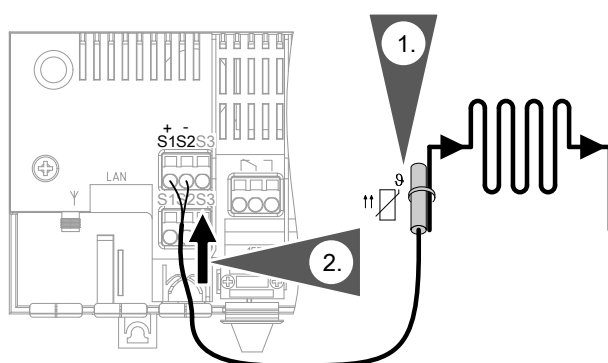

Fig. 13

2. Connect the contact temperature sensor to S1 and S2: See connection diagram on page 15.



Please note

Interchanged connections can damage the appliance.

Take care not to interchange connections S1 and S2.

1. Secure the supplied contact temperature sensor to the flow pipe with the clip.

Note

The ViCare floor thermostat cannot be commissioned if the contact temperature sensor is not fitted.

Connecting the antenna for low power radio

The ViCare floor thermostat has a low power radio interface for communication with a heat generator with Viessmann One Base or Vitoconnect, e.g. type OPTO2.

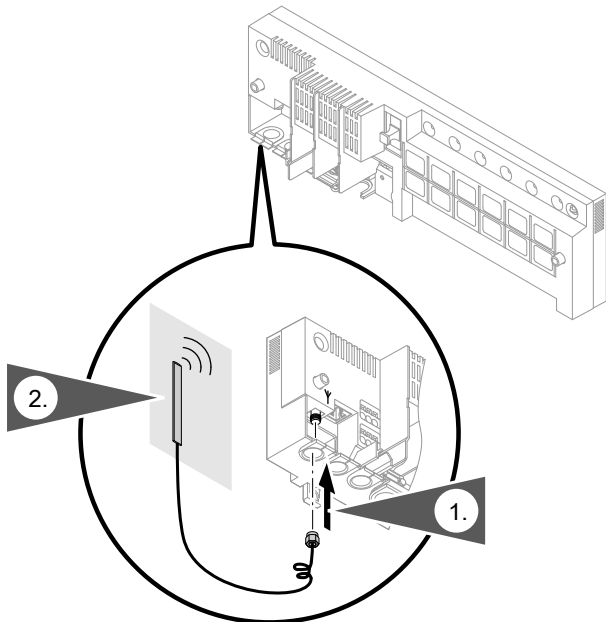

1. Connect the supplied antenna to the ViCare floor thermostat.
2. Affix the antenna in a position outside the distribution box that will allow good wireless transmission: See chapter "Wireless signal range" on page 11.

Fig. 14

Connecting the power cable



Danger

Incorrectly executed electrical installations can result in injuries from electrical current and appliance damage.

Connect the power supply and implement all safety measures (e.g. RCD circuit) in accordance with the following regulations:

- IEC 60364-4-41
- VDE regulations
- TAR medium voltage VDE-AR-N-4110

Max. fuse rating 16 A.

After completing all the previous installation steps, connect the supplied power cable to terminal 40 (A): See connection diagram on page 15. As soon as the floor thermostat is supplied with power, automatic detection of the actuators (pairing process) starts.

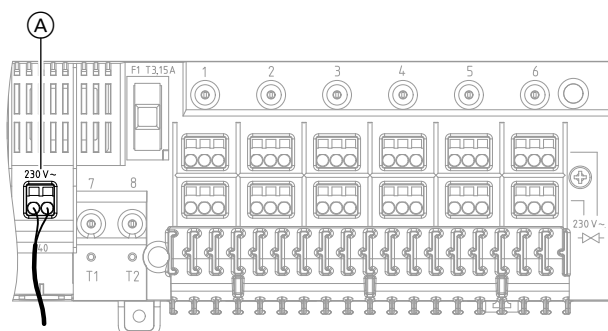

Fig. 15

Display and controls

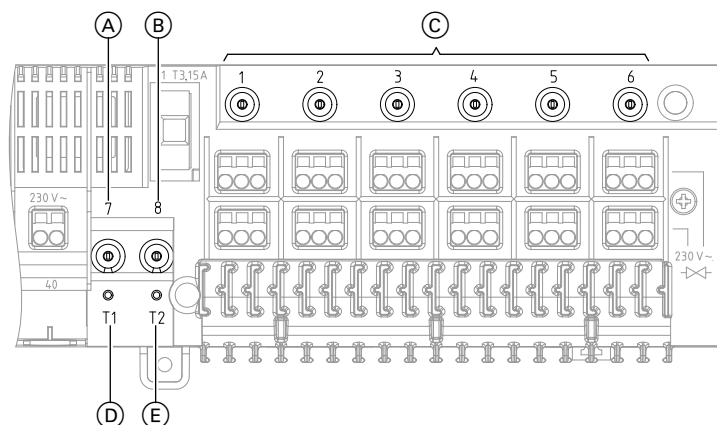

Fig. 16

- (A) LED 7 – status
- (B) LED 8 – heat demand
- (C) LEDs 1 to 6 – heating circuits
- (D) Pushbutton T1 – pairing
- (E) Pushbutton T2 – reset

Key to LEDs

Colour/status of the LEDs	Meaning
LED 1 to LED 6	
Off	No actuator for heating circuit detected. <ul style="list-style-type: none"> ▪ "Normally closed" actuator: Output is not supplied with power. ▪ "Normally open" actuator: Output is supplied with power.
Illuminates green.	Actuator for heating circuit detected. <ul style="list-style-type: none"> ▪ "Normally closed" actuator: Output is supplied with power. ▪ "Normally open" actuator: Output is not supplied with power.
Illuminates orange.	Actuator for heating circuit detected. Set temperature is lower than the actual temperature. <ul style="list-style-type: none"> ▪ "Normally closed" actuator: Output is not supplied with power. ▪ "Normally open" actuator: Output is supplied with power.
Illuminates red.	Short circuit or overload for the actuator detected. The actuator is no longer being controlled. <ul style="list-style-type: none"> ▪ "Normally closed" actuator: Output is not supplied with power. ▪ "Normally open" actuator: Output is supplied with power. <p>Remedy</p> <ul style="list-style-type: none"> ▪ Check connection of flow temperature sensor: See page 16. ▪ Check connection of actuator, see page 15: <ul style="list-style-type: none"> – 230 V actuators must be used. – S1 to brown and S2 to blue always in the same zone. ▪ Check connection of antenna: See page 17. ▪ The floor thermostat's standard plug must be plugged in. 230 V must be present.

Display and controls (cont.)

Colour/status of the LEDs	Meaning
LED 7	
Off	The ViCare floor thermostat is not supplied with power.
Illuminates green.	The ViCare floor thermostat is connected via low power radio to the heat generator with Viessmann One Base or Vitoconnect.
Flashes green.	Actuator pairing process is running.
Illuminates orange.	The ViCare floor thermostat has no connection to the heat generator with Viessmann One Base or Vitoconnect.
Flashing red: ▪ 3 times at intervals ▪ 4 times at intervals	The internal fuse of the ViCare floor thermostat is faulty. Notify your contractor. Software overcurrent detection active
LED 8	
Flashing alternately red/green.	A system reset is being carried out. Or The device will be reset to the factory setting.
Off	▪ No heat demand or ▪ Floor thermostat being operated without connection to a heat generator
Illuminates green.	Heat demand

Function of the pushbuttons

Button		Meaning
T1	▪ Press and hold (> 5 seconds)	Actuator pairing process starts. LEDs 1 to 6 go off. LED 7 flashes green.
T2	▪ Press briefly (< 1 second)	Identification is sent to the heat generator with Viessmann One Base or Vitoconnect.
	▪ Press and hold (> 5 seconds)	The ViCare floor thermostat is reset to the delivered condition.

Inserting the power plug

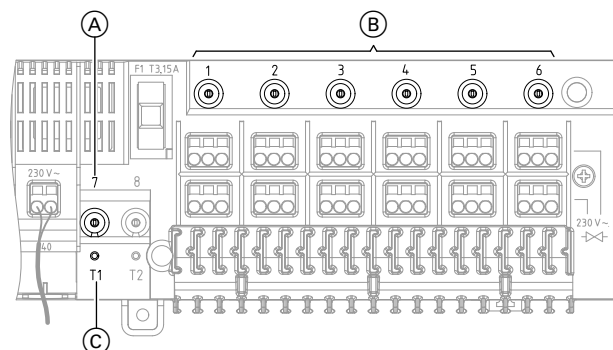

Fig. 17

Insert the power plug.

As soon as the ViCare floor thermostat is supplied with power, the automatic pairing process of the actuators starts. The pairing process unlocks the actuators in a new installation. This takes about 6 minutes.

Meaning of the LEDs during pairing

Colour/status of the LEDs	Meaning
LED 1 to LED 6	
Off	Actuator pairing process is running.
Illuminates orange.	Actuator for heating circuit detected. Output is not supplied with power. Set temperature is lower than the actual temperature.
Illuminates green.	Actuator for heating circuit detected. A set value is pending. <ul style="list-style-type: none"> ▪ "Normally closed" actuator: Output is supplied with power. ▪ "Normally open" actuator: Output is not supplied with power.
LED 7	
Flashes green for 90 seconds.	Actuator pairing process is running.

Starting the actuator pairing process manually

Press T1 (C) with a suitable object for at least 5 seconds. The pairing process starts.

Pairing the ViCare floor thermostat

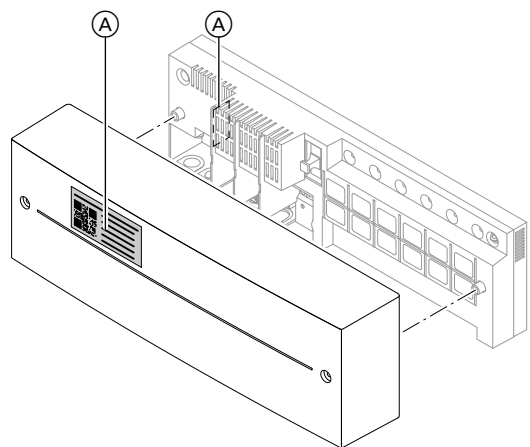

Fig. 18

(A) QR code

1. If you have not already done so, insert the power plug. The pairing process for the low power radio connection is started.
2. Open the ViGuide app: Perform the following settings in the ViGuide app:
 - Activate individual room control.
 - Create rooms.
 - Assign climate sensors to the rooms.
 - Add floor thermostat (scan QR code).
 - Add heating zones.

Pairing the ViCare floor thermostat (cont.)

Note

- At least 1 climate sensor must be connected for each heating zone.
- If "normally open" actuators are installed, the settings in ViGuide need to be adjusted.
- In the ViGuide app, only heating circuits that are actually connected are displayed and their status reported.
- If you want to pair the ViCare floor thermostat with another heat generator with Viessmann One Base or Vitoconnect, you must first reset the ViCare floor thermostat to its factory settings.

Fitting the cover

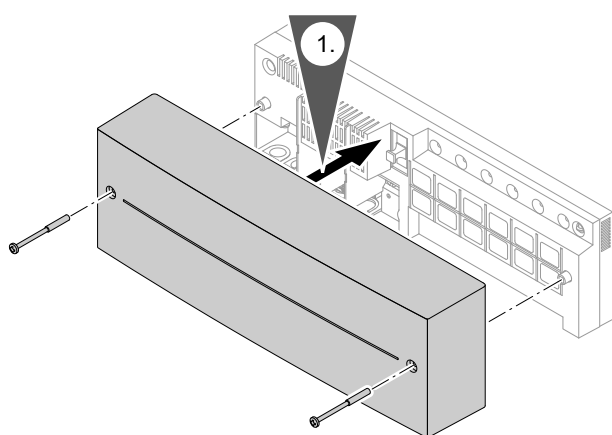

Fig. 19



Inserting cables and applying strain relief

- Apply strain relief to on-site cables.
- Seal any unnecessary apertures with cable grommets (not cut open).

Restoring factory settings

The factory settings of the ViCare floor thermostat can be restored:

- The connection to the heat generator with Viessmann One Base or Vitoconnect is terminated.
- All fault messages and settings are reset.
- All outputs are reset to "normally closed".

Press T2 with a suitable object for at least 5 seconds. LED 7 flashes red 3 times. The factory settings of the ViCare floor thermostat have been restored.

If there is a power failure

When the power supply comes back on, the ViCare floor thermostat automatically resumes operation. Wireless connections are re-established. This may take a few minutes.

If there is a connection fault to the heat generator with Viessmann One Base or Vitoconnect

If wireless communication with the heat generator with Viessmann One Base or Vitoconnect fails for longer than 50 minutes, the heat demand is activated and all valves are controlled with 10 %. When communication is resumed, the valves return to normal mode.

If excess temperatures occur

If the set maximum value is exceeded, all valves are closed to prevent the floor from overheating. When the maximum temperature is undershot by 5 K, the valves return to normal mode.

Maximum value in the delivered condition: 55 °C. The value can be adjusted by your contractor.

If the LED of an actuator lights up red

Short circuit or overload for the actuator detected. The actuator is no longer being controlled.



- "Normally closed" actuator:
Output is **not** supplied with power.
- "Normally open" actuator:
Output is supplied with power.

- Check connection of antenna: See page 17.
- The floor thermostat's standard plug must be plugged in. 230 V must be present.

Remedy

- Check connection of flow temperature sensor: See page 16.
- Check connection of actuator, see page 15:
 - 230 V actuators must be installed.
 - S1 to brown and S2 to blue always in the same zone.

If the actuator is faulty

1. Pull the standard plug of the floor thermostat out of the socket.
2. Open the enclosure of the floor thermostat.
3. Disconnect the faulty actuator at the floor thermostat.
4. Remove the faulty actuator.
 -  Installation instructions for actuator
5. Install a new actuator.
 -  Installation instructions for actuator
6. Connect a new actuator to the floor thermostat and provide strain relief: See page 15.
7. Close the enclosure of the floor thermostat.
8. Re-insert the standard plug of the floor thermostat in the socket.

What to do if...

Frost protection

To protect the fabric of your building, the ViCare floor thermostat keeps the flow temperature at a minimum of 8 °C.

Software update

If a new software update is available, it is automatically downloaded via the heat generator with Viessmann One Base or Vitoconnect and the ViCare floor thermostat is updated.

Checking the contact temperature sensor

Sensor type Pt1000

For connecting the contact temperature sensor: See page 16.

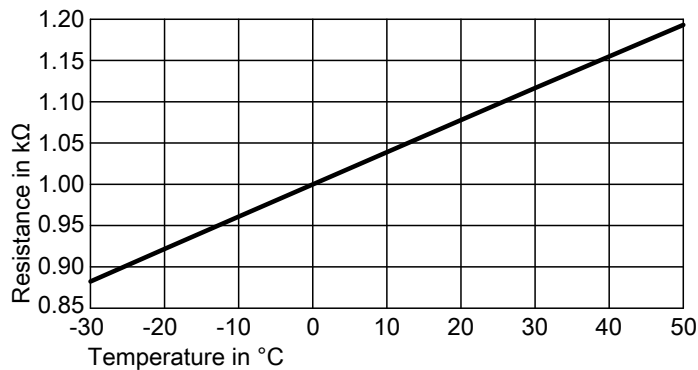

Fig. 20

1. Unplug the temperature sensor.
2. Check the sensor resistance at the plug.
3. Compare the test result with the actual temperature.
If there is marked deviation, check the installation.
Replace sensor if necessary.

Service

The ViCare floor thermostat is largely maintenance-free. Its integrated valve kick function prevents the valves from sticking. This is achieved by fully operating the actuators every 30 days.

If a solenoid valve control or heat demand function is connected to the floating switch, a pump kick function is also triggered, which prevents the pump from seizing up.

Cleaning

You can clean the surfaces of the ViCare floor thermostat with a microfibre cloth. Do not use any cleaning agents.

Specification

Specification

ViCare floor thermostat

Power supply	230 V~ +15/-10 % 50 Hz
Power consumption	4 W
IP rating	IP 22D to EN 60529; ensure through design/installation.
Protection class	II
Connections	<ul style="list-style-type: none"> ▪ Spring-loaded PCB terminals ▪ For service purposes only: RJ45 network connection ▪ RP-SMA antenna connection
Interfaces	1 x LAN network (for service purposes only) 1 x Low power radio 2 x Temperature sensors and/or 1 x Combined humidity and temperature sensor
Low power radio <ul style="list-style-type: none"> ▪ Radio frequency ▪ Frequency band ▪ Encryption ▪ Wireless range through walls 	2.4 GHz 2400.0 to 2483.5 MHz Yes Up to 14 m (depending on wall thickness and wall structure)
Outputs	6 x Thermoelectric control valves Semi-conductor relay 230 V~, permanent current 2 A (max. 6 A) 1 x Solenoid valve control or heat demand Floating switch max. 6 A continuous current
Permissible ambient temperature <ul style="list-style-type: none"> ▪ Operation ▪ Storage and transport 	+5 to +50 °C Installation in living spaces or boiler rooms (standard ambient conditions) -20 to +60 °C

Final decommissioning and disposal of the heating system

Viessmann products can be recycled. Components and fluids from your heating system do not belong in ordinary domestic waste.

Please contact your heating contractor regarding the correct disposal of your old system.

DE: Operating fluids (e.g. heat transfer medium) can be disposed of at municipal collection points.

AT: Operating fluids (e.g. heat transfer medium) can be disposed of at municipal collection points (ASZ).

Keyword index

A		N	
Ambient temperature.....	11	Network.....	10
Ambient temperatures.....	26	Network operator.....	5
Angle of penetration.....	11		
Antenna		O	
– Connecting.....	17	Operation.....	10
App.....	10	Operational reliability.....	5
		Overheating.....	23
C			
Charge, electrostatic.....	14	P	
Cleaning.....	25	PCB.....	14
Commissioning.....	18	Permissible ambient temperatures.....	26
Connection fault.....	23	Power failure.....	23
Connections.....	14	Product information.....	7
Contractors, identification.....	6		
Controls.....	18	R	
Control valve		Remote control.....	10
– Connecting.....	15	Remote monitoring.....	10
Cover, fitting.....	21		
		S	
D		Sensor check.....	25
Data connections, ViCare floor thermostat.....	8	Service.....	25
Display.....	18	Software update.....	25
		Specification.....	26
E			
Electrical connections.....	14	T	
Electrostatic charge.....	14	Temperature sensor	
Email.....	5	– Connecting.....	16
Enclosure, opening.....	14	Terms and Conditions.....	5
Excess temperature.....	23	Top-hat rail mounting.....	13
F		U	
Factory settings, restoring.....	22	Update.....	25
Functions.....	7		
		V	
G		ViCare floor thermostat	
General Terms and Conditions.....	5	– Pairing.....	20
		ViGuide.....	10
I			
Installation		W	
– Top-hat rail.....	13	Wall mounting.....	14
– Wall.....	14	Wireless signal range.....	11
Installation location.....	11		
Intended use.....	6		
L			
Liability.....	5		
Low power radio			
– Antenna, connecting.....	17		

Viessmann Climate Solutions SE
35108 Allendorf / Germany
Telephone: +49 6452 70-0
Fax: +49 6452 70-2780
www.viessmann.com



Viessmann Limited
Hortonwood 30, Telford
Shropshire, TF1 7YP, GB
Telephone: +44 1952 675000
Fax: +44 1952 675040
E-mail: info-uk@viessmann.com